

KAWAI

ES520 Owner's Manual

Important Information

Preparation

Basic Operation

Adjustments & Settings

Appendix

EN

Important Safety Instructions

SAVE THESE INSTRUCTIONS

INSTRUCTIONS PERTAINING TO A RISK OF FIRE, ELECTRIC SHOCK, OR INJURY TO PERSONS



WARNING

TO REDUCE THE RISK OF FIRE OR ELECTRIC SHOCK, DO NOT EXPOSE THIS PRODUCT TO RAIN OR MOISTURE.

AVIS : RISQUE DE CHOC ELECTRIQUE - NE PAS OUVRIR.

TO REDUCE THE RISK OF ELECTRIC SHOCK, DO NOT REMOVE COVER (OR BACK). NO USER-SERVICEABLE PARTS INSIDE. REFER SERVICING TO QUALIFIED SERVICE PERSONNEL.



The lightning flash with arrowhead symbol, within an equilateral triangle, is intended to alert the user to the presence of uninsulated "dangerous voltage" within the product's enclosure that may be of sufficient magnitude to constitute a risk of electric shock to persons.



The exclamation point within an equilateral triangle is intended to alert the user to the presence of important operating and maintenance (servicing) instructions in the literature accompanying the product.

Examples of Picture Symbols



denotes that care should be taken.
The example instructs the user to take care not to allow fingers to be trapped.



denotes a prohibited operation.
The example instructs that disassembly of the product is prohibited.



denotes an operation that should be carried out.
The example instructs the user to remove the power cord plug from the AC outlet.

Read all the instructions before using the product.

- 1) Read these instructions.
- 2) Keep these instructions.
- 3) Heed all warnings.
- 4) Follow all instructions.
- 5) Do not use this apparatus near water.
- 6) Clean only with dry cloth.
- 7) Do not block any ventilation openings. Install in accordance with the manufacturer's instructions.
- 8) Do not install near any heat sources such as radiators, heat registers, stoves, or other apparatus (including amplifiers) that produce heat.
- 9) Do not defeat the safety purpose of the polarized or grounding-type plug. A polarized plug has two blades with one wider than the other. A grounding type plug has two blades and a third grounding prong. The wide blade or the third prongs are provided for your safety. If the provided plug does not fit into your outlet, consult an electrician for replacement of the obsolete outlet.
- 10) Protect the power cord from being walked on or pinched particularly at plugs, convenience receptacles, and the point where they exit from the apparatus.
- 11) Only use attachments/accessories specified by the manufacturer.
- 12) Use only with the cart, stand, tripod, bracket, or table specified by the manufacturer, or sold with the apparatus. When a cart is used, use caution when moving the cart/apparatus combination to avoid injury from tip-over. 
- 13) Unplug this apparatus during lightning storms or when unused for long periods of time.
- 14) Refer all servicing to qualified service personnel. Servicing is required when the apparatus has been damaged in any way, such as power-supply cord or plug is damaged, liquid has been spilled or object have fallen into the apparatus, the apparatus has been exposed to rain or moisture, does not operate normally, or has been dropped.

WARNING - When using electric products, basic precautions should always be followed, including the following:



WARNING

Indicates a potential hazard that could result in death or serious injury if the product is handled incorrectly.

The product should be connected to an AC outlet of the specified voltage.



- If you are going to use an AC power cord, make sure that its has the correct plug shape and conforms to the specified power voltage.
- Failure to do so may result in fire.

Do not insert or disconnect the power cord plug with wet hands.



Doing so may cause electric shock.

Take care not to allow any foreign matter to enter the product.



Entry of water, needles or hair pins may result in breakdown or short-circuit. The product shall not be exposed to dripping or splashing. No objects filled with liquids, such as vases, shall be placed on the product.

When using the headphones, do not listen for long periods of time at high volume levels.

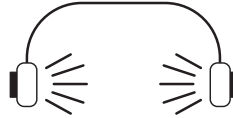

Doing so may result in hearing problems.

Do not lean against the keyboard.

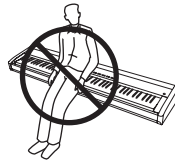

Doing so may cause the product to fall over, resulting in injury.

Do not use the product in wet areas, or areas close to water.



Doing so may cause a short circuit, leading to an electric shock, or a fire.

Do not disassemble, repair or modify the product.



Doing so may result in product breakdown, electric shock or short-circuit.

When disconnecting the AC power cord's plug, always hold the plug and pull it to remove it.



- Pulling the AC power cord itself may damage the cord, causing a fire, electric shock or short-circuit.

The product is not completely disconnected from the power supply even when the power switch is turned off. If the product will not be used for a long time, unplug the AC power cord from the AC outlet.



- Failure to do so may cause fire in case of lightning.
- Failure to do so may over-heat the product, resulting in fire.

This product may be equipped with a polarized line plug (one blade wider than the other). This is a safety feature. If you are unable to insert the plug into the outlet, contact an electrician to replace your obsolete outlet. Do not defeat the safety purpose of the plug.

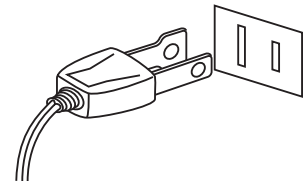

This product shall be near the AC outlet and the power cord plug in a position so that it can readily be disconnected in an emergency because electricity is always charging while the plug is in the AC outlet even in a power switch off condition.



CAUTION

Indicates a potential hazard that could result in injury or damage to the product or other property if the product is handled incorrectly.

Do not use the product in the following areas.

- Areas, such as those near windows, where the product is exposed to direct sunlight
- Extremely hot areas, such as near a heater
- Extremely cold areas, such as outside
- Extremely humid areas
- Areas where a large amount of sand or dust is present
- Areas where the product is exposed to excessive vibrations

Using the product in such areas may result in product breakdown. Use the product only in moderate climates (not in tropical climates).

- Do not stand the main unit on its side for extended periods of time.
- Do not attempt to play the main unit at unusual angles.

Doing so may place stress on the keyboard action, resulting in breakdown of the product.

Use only the AC adaptor included with this instrument to power the instrument.

- Do not use other AC adaptors to power this instrument.
- Do not use the included AC adaptor or AC power cord to power other equipment.

Before connecting cords, make sure that the power to this product and other devices is turned OFF.



Failure to do so may cause breakdown of this product and other devices.

Do not drag the product on the floor. Take care not to drop the product.

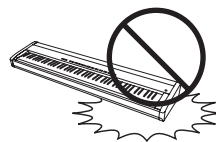

Please lift up the product when moving it. Please note that the product is heavy and must be carried by more than two persons. Dropping the product may result in breakdown.

Do not place the product near electrical appliances such as TVs and radios.

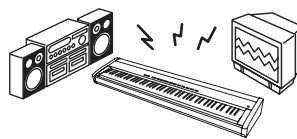

- Doing so may cause the product to generate noise.
- If the product generates noise, move the product sufficiently away from the electrical appliance or connect it to another AC outlet.

When connecting the AC power cord and other cords, take care not to get them tangled.



Failure to do so may damage them, resulting in fire, electric shock or short-circuit.

Do not wipe the product with benzene or thinner.



- Doing so may result in discoloration or deformation of the product.
- When cleaning the product, put a soft cloth in lukewarm water, squeeze it well, then wipe the product.

Do not stand on the product or exert excessive force.



- Doing so may cause the product to become deformed or fall over, resulting in breakdown or injury.

Do not place naked flame, such as lighted candles on the product.



Doing so may cause the illumination to fall over, resulting in fire.

Ensure that the ventilation is not impeded by covering the ventilation openings with items, such as newspaper, table-cloths, curtains, etc.



Failure to do so may over-heat the product, resulting in fire.

The product should be located so that its location or position does not interfere with its proper ventilation. Ensure a minimum distance of 5cm around the product for sufficient ventilation.

The product should be serviced by qualified service personnel when:

- The power supply cord or the plug has been damaged.
- Objects have fallen, or liquid has been spilled into the product.
- The product has been exposed to rain.
- The product does not appear to operate normally or exhibits a marked change in performance.
- The product has been dropped, or the enclosure damaged.

Notes on Repair

Should an abnormality occur in the product, immediately turn the power OFF, disconnect the power cord plug, and then contact the shop from which the product was purchased.

CAUTION:

To prevent electric shock, match wide blade of plug to wide slot, fully insert.

ATTENTION:

Pour éviter les chocs électriques, introduire la lame la plus large de la fiche dans la borne correspondante de la prise et pousser jusqu'au fond.



An information on Disposal for users

If your product is marked with this recycling symbol it means that, at the end of its life, you must dispose of it separately by taking it to an appropriate collection point. You should not mix it with general household waste. Disposing of this product correctly will prevent potential negative effects on the environment and human health which could otherwise arise due to inappropriate waste handling. For further details, please contact your local authority. (European Union only)

Instruction for AC power cord (U.K.)

IMPORTANT

THE WIRES IN THIS MAINS LEAD ARE COLOURED IN ACCORDANCE WITH THE FOLLOWING CODE.

- BLUE : NEUTRAL
- BROWN : LIVE

As the colours of the wires in the mains lead of this apparatus may not correspond with the coloured markings identifying the terminals in your plug, proceed as follows:

The wire which is coloured BLUE must be connected to the terminal which is marked with the letter N or coloured BLACK. The wire which is coloured BROWN must be connected to the terminal which is marked with the letter L or coloured RED. Do not plug either terminal of the power cord to the the ground AC outlet on the wall.

Canadian Radio Interference Regulations

This instrument complies with the limits for a class B digital apparatus, pursuant to the Radio Interference Regulations, C.R.C., c. 1374.

FCC Information (U.S.A)

CAUTION: Changes or modifications not expressly approved by the party responsible for compliance could void the user's authority to operate the equipment.

NOTE: This equipment has been tested and found to comply with the limits for a Class B digital device, pursuant to Part 15 of the FCC Rules. These limits are designed to provide reasonable protection against harmful interference in a residential installation. This equipment generates, uses and can radiate radio frequency energy and, if not installed and used in accordance with the instructions, may cause harmful interference to radio communications. However, there is no guarantee that interference will not occur in a particular installation. If this equipment does cause harmful interference to radio or television reception, which can be determined by turning the equipment off and on, the user is encouraged to try to correct the interference by one or more of the following measures:

- Reorient or relocate the receiving antenna.
- Increase the separation between the equipment and receiver.
- Connect the equipment into an outlet on a circuit different from that to which the receiver is connected.
- Consult the dealer or an experienced radio/TV technician for help.



Declaration of Conformity

Products :	Electronic Piano
Model Number :	ES520
Responsible Party Name :	Kawai America Corporation
Address :	2055 East University Drive Rancho Dominguez, CA 90220
Telephone :	310-631-1771

This device complies with Part 15 of the FCC Rules. Operation is subject to the following two conditions:

- (1) this device may not cause harmful interference, and
- (2) this device must accept any interference received, including interference that may cause undesired operation.

The nameplate label is located on the underside of the instrument, as indicated below.

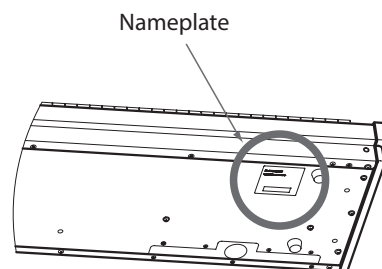

This applies only to products distributed by Kawai America Corporation.

Displayed Icons



- Bluetooth icon**
Displayed when Bluetooth Audio or Bluetooth MIDI is on.
- Transpose icon**
Displayed when key TRANSPOSE is on.
- Headphone icon**
Displayed when a pair of headphones is connected.
- USB icon**
Displayed when a USB memory device is connected.
- Panel lock icon**
Displayed when panel lock is on.

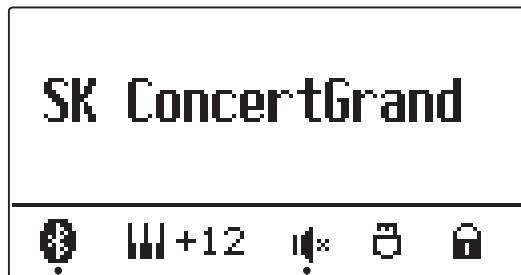

- * Displayed when a Bluetooth connection is made.**
- * Displayed when the SPEAKER switch is off.**
(Headphone icon is displayed when a pair of headphones is connected)

Table of Contents

Important Information

Important Safety Instructions	3
Displayed Icons	7
Table of Contents	8
Welcome to the Kawai ES520	10
1. Package Contents	10
2. Feature Highlights	11
Part Names and Functions	12

Preparation

Setting Up the Piano	14
Basic Operation	15

Basic Operation

Selecting Sounds	16
Demo Songs	17
Dual Mode	18
Split Mode	20
Four Hands Mode	22
Enhancing the Sound	24
1. Reverb	24
2. Effects	26
3. Amp Simulator	29
Panel Lock	31
Transpose	32
Metronome	33
Rhythm	35
Registration Memories	37
Song Recorder (Internal memory)	39
1. Recording a Song	39
2. Playing a Song	41
3. Erasing a Song	43
Playing a MIDI or KSO file (USB memory)	44

USB Menu	46
1. Load Registration	47
2. Save Internal Song	48
3. Save Registration	49
4. Rename File	50
5. Delete File	51

Adjustments & Settings

Settings Menus	52
Basic Settings	53
1-1. Tone Control	54
Brilliance	54
User EQ	55
1-2. Tuning	56
1-3. Damper Hold	56
1-4. Four Hands	57
1-5. Startup Setting	58
1-6. Factory Reset	59
1-7. Auto Display Off	60
1-8. Auto Power Off	61
Virtual Technician	62
2-1. Touch Curve	64
2-2. Voicing	65
User Voicing	66
2-3. Damper Resonance	67
2-4. Damper Noise	67
2-5. String Resonance	68
2-6. Key-off Effect	69
2-7. Fall-back Noise	70
2-8. Hammer Delay	71
2-9. Topboard	72
2-10. Decay Time	73
2-11. Minimum Touch	73

2-12. Temperament	74
Stretch Tuning	75
Stretch Curve	76
Temperament Key	76
User Temperament	77
2-13. User Key Volume	77
2-14. Half-Pedal Adjust	78
2-15. Soft Pedal Depth	78
Key Settings	79
3-1. Lower Octave Shift	80
3-2. Lower Pedal	81
3-3. Split Balance	81
3-4. Layer Octave Shift	82
3-5. Layer Dynamics	83
3-6. Dual Balance	83
Phones Settings	84
4-1. SHS Mode	85
4-2. Phones Type	86
MIDI Settings	87
Bluetooth Settings	87
6-1. Bluetooth Audio	88
6-2. Bluetooth Audio Volume	89
6-3. Bluetooth MIDI	90

Appendix

Connecting to Other Devices	91
Rear Connectors	92
Upper Connectors	92
Front Connectors	92
USB MIDI (USB to Host Connector)	93
Information about Bluetooth®	94
Troubleshooting	95
Demo Song List	96
EU Declaration of Conformity	97
Kawai ES520 Specifications	98
Owner's Manual Conventions	99

Welcome to the Kawai ES520

Thank you for purchasing this Kawai ES520 digital piano.

This owner's manual contains important information regarding the usage and operation of the ES520 digital piano.

Please read all sections carefully, keeping this manual handy for future reference.

1 Package Contents

The Kawai ES520 digital piano package contains the following items:

■ ES520 digital piano

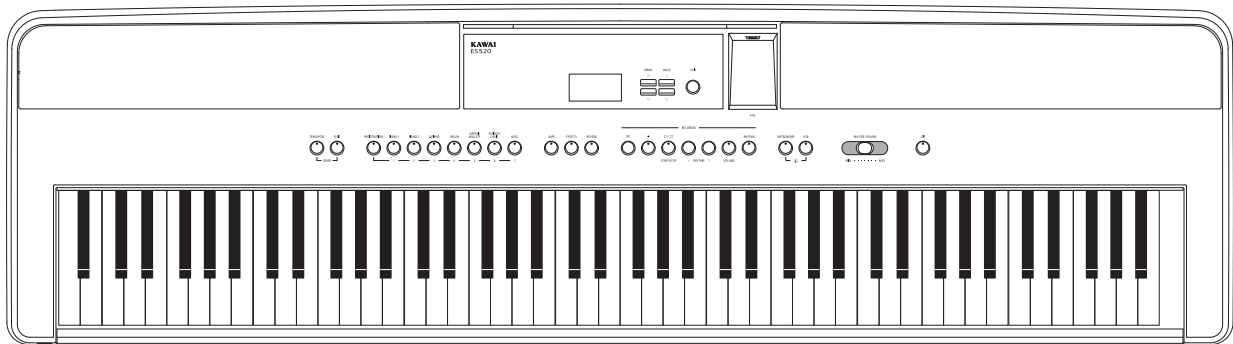

■ AC adapter (PS-154)/Power cable

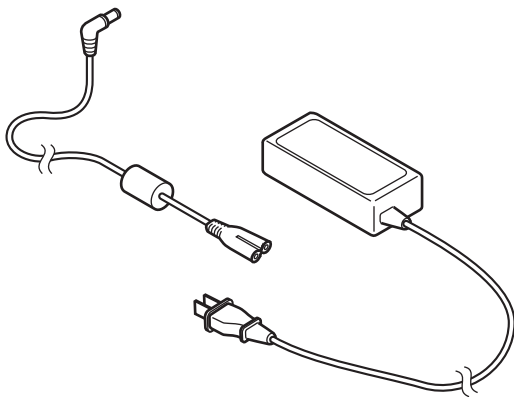

■ Foot pedal (F-10H)

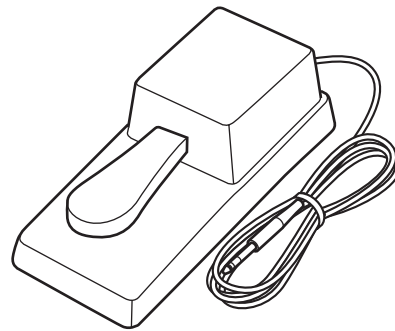

■ Music rack/rest

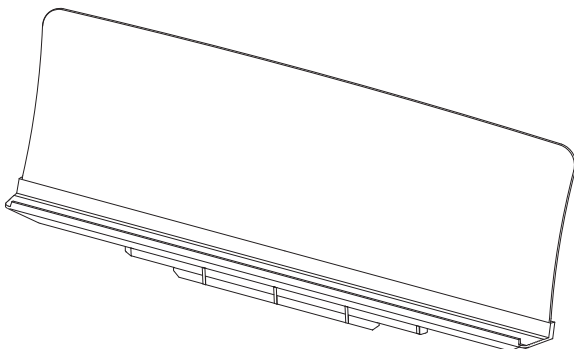

■ Owner's manual

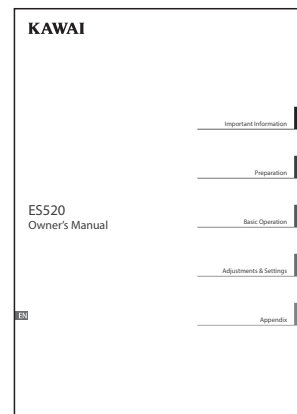

2 Feature Highlights

Responsive Hammer Compact II (RHC II) weighted-key keyboard action

The new *Responsive Hammer Compact II* (RHC II) action has been developed to reproduce the distinctive touch of an acoustic grand piano. The weight of the keyboard is appropriately graded to mirror the heavier bass and lighter treble hammers of acoustic pianos, with a smooth matte texture applied to each black and white key for enhanced playability. As with other Kawai digital piano keyboard actions, *Responsive Hammer Compact II* utilises triple sensor hammer velocity detection, and features a springless mechanism that delivers a smooth and natural piano playing experience.

Despite its lightweight, compact design, the RHC II action allows experienced pianists to perform with confidence, playing fortissimo with power and certainty, while delicately controlling the softest, most gentle pianissimo passages.

Shigeru Kawai SK-EX and Kawai EX instruments reproduced with Harmonic Imaging sound technology

The ES520 digital piano captures the rich, expressive sound of the Kawai SK-EX and EX grand pianos, with all 88 keys of these exceptional instruments meticulously recorded, analysed and faithfully reproduced using *Progressive Harmonic Imaging™* sound technology. This unique process accurately recreates the broad dynamic range of the original grand pianos, affording pianists an extraordinary level of expressiveness ranging from the softest pianissimo to the strongest, boldest fortissimo.

The instrument's built-in *Virtual Technician* feature allows various characteristics of these acoustic piano sounds to be shaped at the touch of a button, with settings to adjust string and damper resonance, in addition to subtle hammer, damper, and key release noises. This personalised piano sound is further enhanced with atmospheric reverberation effects, delivering a rich, vibrant piano tone with breathtaking realism and authenticity.

Strong selection of additional instrument sounds

Supplementing the realistic acoustic piano voices, the ES520 digital piano also features a strong selection of additional instrument sounds, ranging from electric pianos and drawbar and church organs, to string, choir, and mallet instruments, inviting musicians to add greater variety to their performances.

Furthermore, the *Dual* playing mode also allows two different sounds, such as grand piano and strings, to be layered together, while the *Split* and *Four Hands* modes divide the keyboard into two independent sections. The volume balances for each playing mode can also be adjusted quickly and easily using the real-time panel controls.

Wide range of connectivity options

The ES520 digital piano features a variety of standard connectivity options, with Line-level output jacks that allow the instrument to be enjoyed in larger settings such as churches and schools. Standard MIDI and *USB to Host* connectors ensure flexibility when using computers and other electronic instruments.

Integrated Bluetooth® 0connectivity

In addition to standard MIDI jacks for connecting to other instruments, the ES520 digital piano also boasts integrated Bluetooth MIDI and Audio technology that allows the instrument to communicate with supported smart devices wirelessly. Once connected to a phone, tablet, or laptop, ES520 digital piano owners can enjoy a wide variety of exciting music-related apps that enhance their learning and playing experience, or stream audio from songs and videos through the instrument's speakers without additional cables.

* Availability of Bluetooth function dependent on market location.

Part Names and Functions

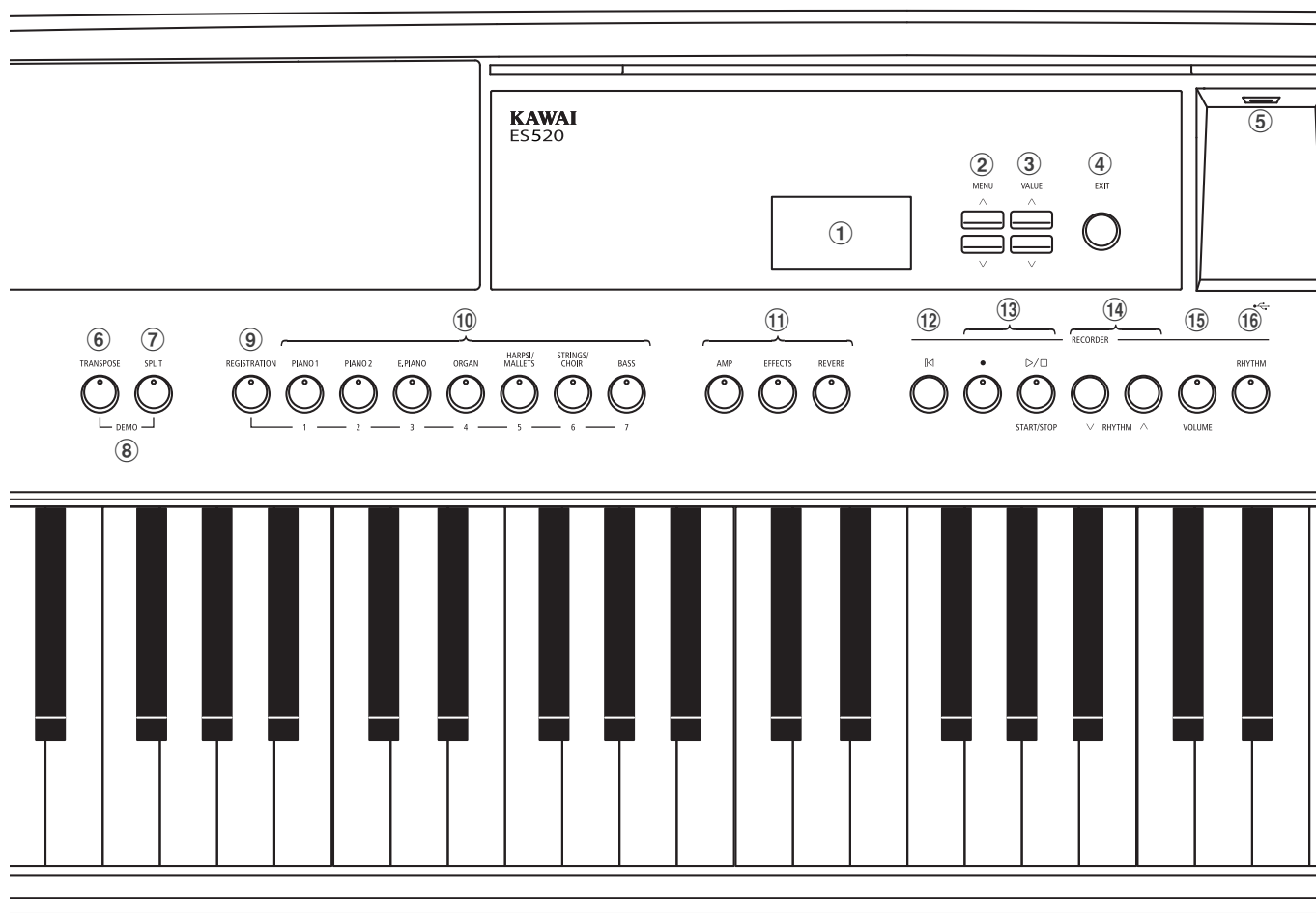

① Display

The display provides important information relating to the currently selected sound, style, function, and setting.

* A protective plastic film is attached to the display during production. Please remove this film before attempting to play the instrument.

② MENU buttons

These buttons are used to navigate through the instrument's various function and settings menus.

③ VALUE buttons

These buttons are used to adjust values, and change settings etc.

④ EXIT button

This button is used to exit the current function, or return to the previous screen.

⑤ USB to Device port (Type A)

This port is used to connect a FAT or FAT32 formatted USB memory device to the instrument in order to load/save recorded song data, registration memories, and SMF files etc.

* Use this port for connecting USB memory devices only.

* Connect the USB memory device directly, without using a USB extension cable.

⑥ TRANSPOSE button

This button is used to adjust the pitch of the instrument's keyboard in semi-tone steps.

⑦ SPLIT button

This button is used to select and adjust the instrument's Split/Four Hands mode functions.

⑧ DEMO button

When pressed simultaneously, the TRANSPOSE and SPLIT buttons are also used to select the instrument's Demo mode.

⑨ REGISTRATION button

This button is used to store and recall one of the 28 different Registration memories. Each Registration can store sound, reverb/effects, and Virtual Technician settings, as well as various other panel and menu options.

⑩ SOUND buttons

These buttons are used to select the sound(s) that will be heard when playing the instrument's keyboard.

These buttons are also used to select Registration memories.

⑪ AMP/EFFECTS/REVERB buttons

These buttons are used to turn the instrument's amp, reverb, and effects functions on/off, and to adjust their various settings.

⑫ (RESET) button

This button is used to reset the instrument's song recorder, and to rewind songs and SMF files to the beginning.

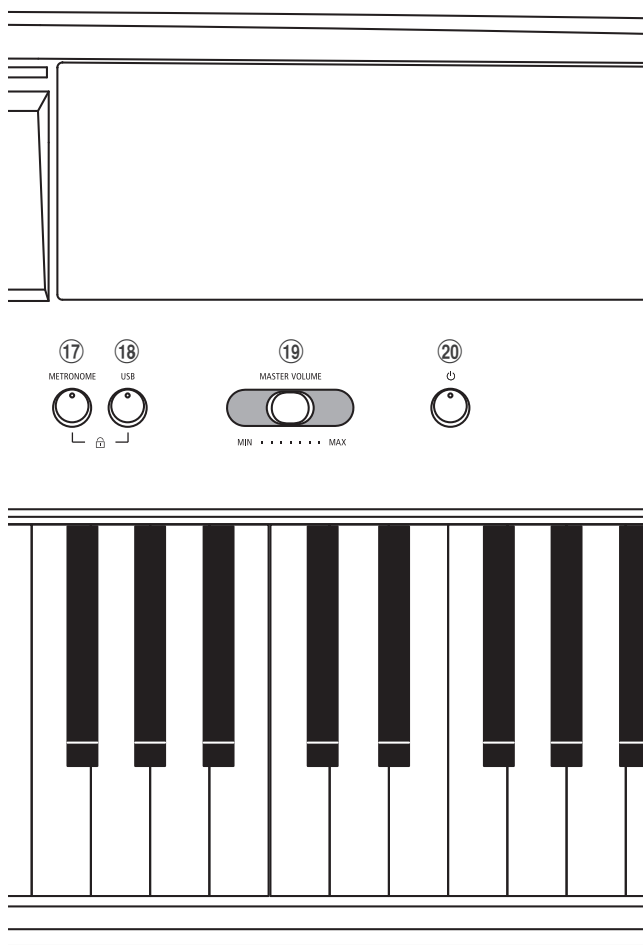

13 ● (REC) and

▷/◻ (PLAYBACK / START/STOP) buttons

These buttons are used to record and playback songs stored in the instrument's internal memory, or SMF files saved to a USB memory device.

14 RHYTHM ∨ / ∧ buttons

These buttons are used to select the Rhythm style.

15 VOLUME button

This button is used to display the rhythm volume adjustment screen by a single touch of the button.

16 RHYTHM button

This button is used to play the rhythm.

17 METRONOME button

This button is used to turn the instrument's metronome function on/off, and to adjust metronome settings.

18 USB button

This button is used to access the instrument's USB functions.

When pressed simultaneously, the METRONOME and USB buttons are used to toggle the instrument's Panel Lock feature.

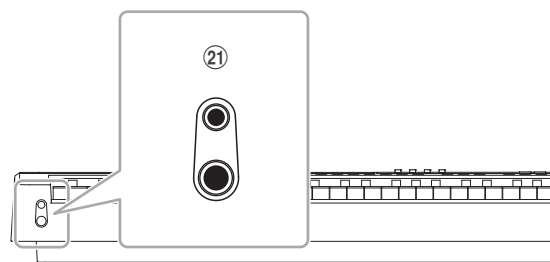

19 MASTER VOLUME slider

This slider controls the master volume level of the instrument's built-in speakers, LINE OUT, and headphones, if connected.

20 POWER button

This button is used to turn the instrument on and off. Be sure to turn off the instrument after use.

* The ES520 digital piano features a power saving mode that can turn off the instrument automatically after a specified period of inactivity. For more information, please refer to the Auto Power Off setting on page 61.

21 PHONES jacks

These jacks are used to connect stereo headphones to the instrument. Two pairs of headphones can be connected and used simultaneously.

* For more information about connectors/jacks, please refer to page 91.

Setting Up the Piano

Upon unboxing the instrument, please follow the instructions below which explain how to attach the music rest, connect the F-10H (or optional GFP-3) foot pedal, and if desired, connect a pair of headphones.

■ Attaching the music rest

Insert the base of the music rest into the groove located at the rear of the ES520 digital piano, taking care not to scratch the rear of the instrument.

To prevent possible damage, avoid applying excessive force when attaching/detaching the music rest from the instrument.

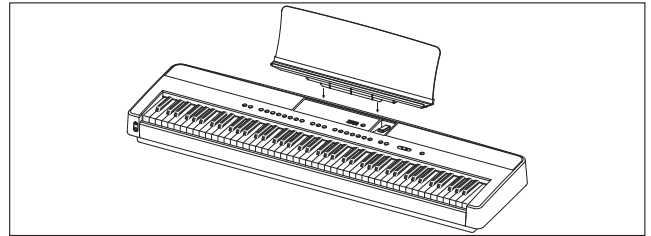

■ Connecting the F-10H foot pedal

Connect the included Kawai F-10H foot pedal to the DAMPER pedal jack located on the rear panel of the instrument.

The foot pedal will function as a damper pedal, sustaining the sound after hands are lifted from the keyboard. This pedal is capable of responding to “half pedaling”.

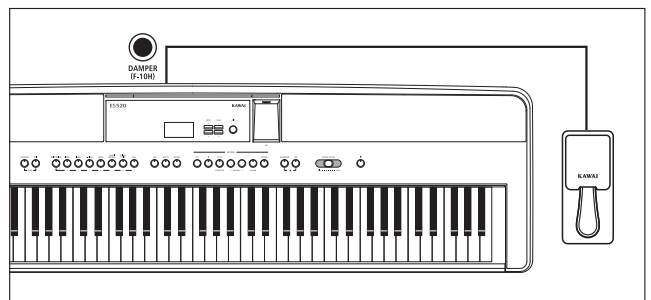

■ Connecting the optional GFP-3 triple pedal

Connect the optional Kawai GFP-3 triple pedal to the DAMPER/SOFT pedal jack located on the rear panel of the instrument.

The right pedal will function as a damper pedal, sustaining the sound after hands are lifted from the keyboard. This pedal is also capable of responding to “half pedaling”.

The centre pedal will function as a sostenuto pedal, and the left pedal will function as a soft pedal.

* When “Jazz Organ”, “Drawbar Organ” or “Ballad Organ” sounds are selected, the soft pedal can also be used to alternate the speed of the rotary speaker effect between “Slow” and “Fast” modes.

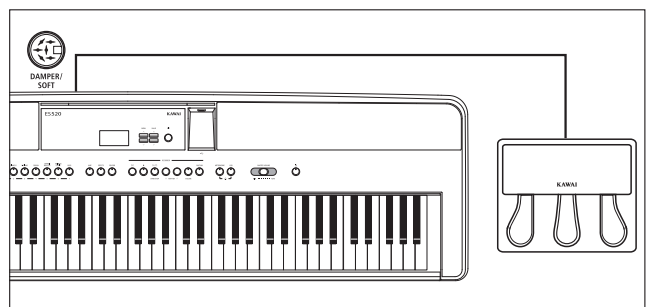

■ Connecting headphones

Use the jacks located on either side of the keyboard to connect stereo headphones to the ES520 digital piano.

There are one standard jack and one mini jack so up to two pairs of headphones can be connected. When a pair of headphones is connected, sound will not be produced by the built-in speakers.

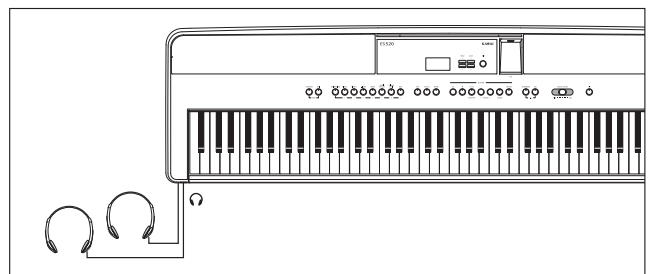

■ Turning built-in speakers on/off

Set the SPEAKER switch located on the rear panel to the Off position to disable the instrument’s built-in speakers. Set the switch to the On position to enable the speakers.

* When a pair of headphones is connected, sound will not be produced from the built-in speakers regardless of the status of the SPEAKER switch.

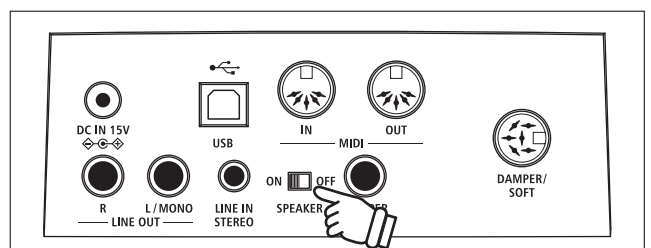

Basic Operation

The following instructions explain how to connect the instrument to the power outlet, turn on the power, adjust the volume to a comfortable level, and begin playing the piano.

1. Connecting the power adaptor

Connect the included AC power adaptor to the "DC IN" jack located on the rear panel of the instrument, indicated below.

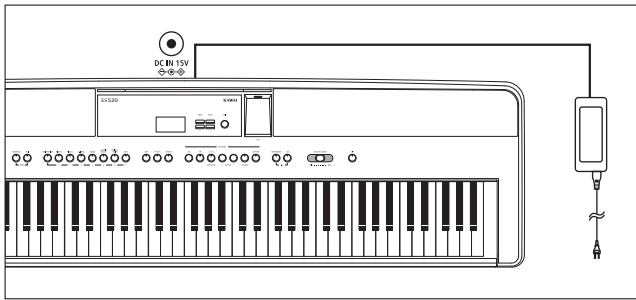

Connect the AC power adaptor to an AC outlet.

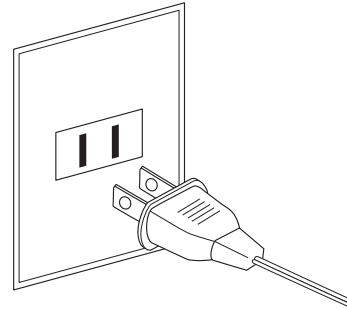

2. Turning on the instrument's power

Press the POWER button located on the right side of the instrument's control panel.

The instrument will turn on, and the words "SK ConcertGrand" will be shown in the display, indicating that the SK ConcertGrand sound is selected. The LED indicator for the PIANO 1 button will also turn on.



LED indicator on:
Sound category is selected.

* The ES520 digital piano features a power saving mode that can turn off the instrument automatically after a specified period of inactivity. For more information, please refer to the Auto Power Off setting on page 61.

3. Adjusting the volume

The MASTER VOLUME slider controls the volume level of the instrument's speakers, LINE OUT, and headphones if connected.

Move the slider to the right to increase the volume, and to the left to decrease the volume.

Use this slider to set the volume to a comfortable listening level - the middle is often a good starting point.

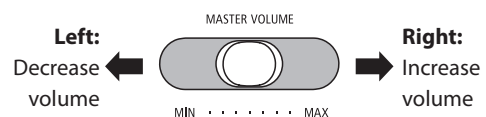

4. Play the piano

Begin playing the piano.

The rich sound of a Kawai SK-EX Concert Grand Piano will be heard as the keys are pressed.

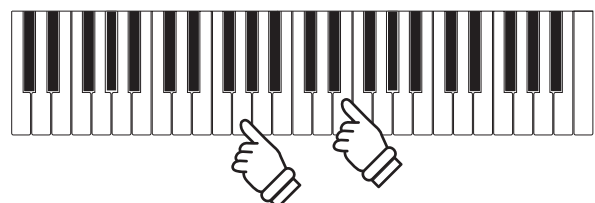

Selecting Sounds

The ES520 digital piano features a wide selection of realistic instrument sounds suitable for various musical styles. Sounds are arranged into seven categories, with multiple sounds assigned to each category button.

By default, the "SK ConcertGrand" sound will be selected automatically when the instrument is turned on.

Sound categories and variations

PIANO 1		PIANO 2		E. PIANO		ORGAN	
1	SK ConcertGrand	1	Upright Piano	1	Classic E.Piano	1	Jazz Organ
2	EX ConcertGrand	2	Pop Grand	2	Classic E.P. 2	2	Drawbar Organ
3	Jazz Clean	3	Modern Piano	3	60's E.Piano	3	Ballad Organ
4	Warm Grand	4	Rock Piano	4	60's E.Piano 2	4	Principal Oct.
				5	Modern E.Piano	5	Church Organ

HARPSI / MALLETS		STRINGS / CHOIR		BASS	
1	Harpichord	1	String Ensemble	5	Choir
2	Vibraphone	2	Slow Strings	6	Square Pad
3	Clavi	3	String Pad	7	New Age Pad
4	Marimba	4	Warm Strings		

BASS	
1	Electric Bass
2	Electric Bass 2
3	Electric Bass 3
4	Wood Bass
5	W. Bass & Ride

1. Selecting a sound category

Press the desired SOUND button.

The LED indicator for the button will turn on to indicate that this category has been selected, and the name of the sound will be shown in the display.

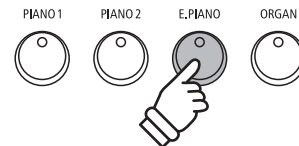

Example: To select the E.PIANO category, press the E.PIANO button.

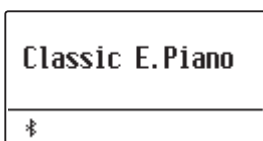

2. Changing the selected sound variation

Several sound variations are assigned to each category button.

Press a SOUND button repeatedly to cycle through the different sound variations.

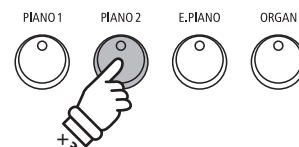

Example: To select the "Pop Grand" sound, press the PIANO2 button two times.

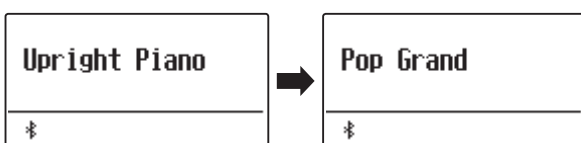

The √ or ∧ VALUE buttons can also be used to select sounds, and cycle through the different sound variations.

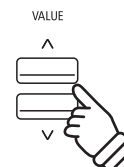

Demo Songs

The Demo function provides an excellent introduction to the varied capabilities of the ES520 digital piano. There are 23 different demonstration songs available, highlighting the instrument's rich selection of high quality sounds and powerful speaker system.

For a complete listing of the available demonstration songs, please refer to page 96 of this owner's manual.

* Kawai regrets that sheet music for Kawai original demo songs is not available.

1. Entering demo mode

Press the TRANSPOSE and SPLIT buttons simultaneously.

The LED indicators for both buttons will start to flash to indicate that demo mode is in use, and the Demo song will start to play.

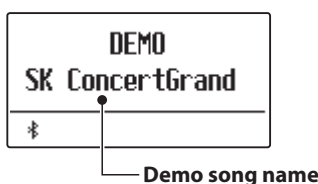
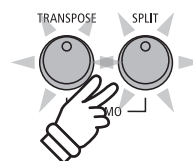

* When the Demo song has finished, a sound demo song will be selected at random, and will start to play.

2. Selecting a demo song

While Demo mode is selected and the demo songs are playing:

Press the desired SOUND button.

The LED indicator for the button will start to flash, and the first demo in the selected sound category will start to play.

Press the selected sound category button repeatedly to cycle through the different demo songs in that category.

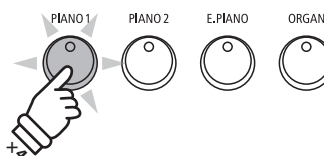

Example: To select the Warm Grand demo song, press the PIANO1 button four times.



The √ or ^ VALUE buttons can also be used to cycle through all of the different demo songs.

The √ or ^ MENU buttons can be used to switch for each group.

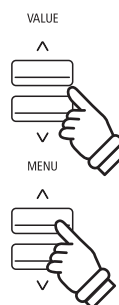

3. Stopping the demo song and exiting demo mode

While Demo mode is selected and the demo songs are playing:

Press the EXIT button.

The LED indicators will stop flashing, the demo songs will stop playing, and the instrument will return to normal playing mode.

* The TRANSPOSE button or SPLIT button can also be used to stop them.

EXIT



Dual Mode

The Dual Mode function allows two sounds to be layered together, creating a more complex sound. For example, a piano sound layered with strings, or a church organ combined with a choir, etc.

1. Entering Dual mode

Press and hold a SOUND button to select the main sound, then press another SOUND button to select the layered sound.

The LED indicators for both SOUND buttons will turn on to indicate that Dual mode is in use, and the respective sound names will be shown in the display.

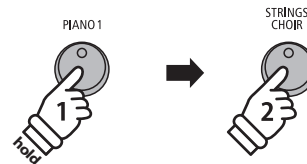
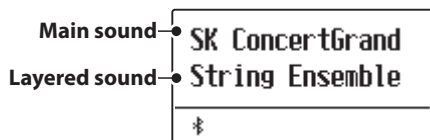

Example: To layer the "Slow Strings" sound with the "SK ConcertGrand" sound, press and hold the PIANO1 button, then press the STRINGS/CHOIR button.

2. Changing the main/layered sounds

To select a different variation for the layered sound:

Press and hold the main SOUND button, then press the layered SOUND button repeatedly to cycle through the different sound variations.

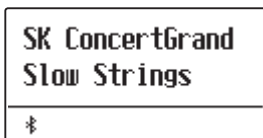

To select a different variation for the main sound:

Press and hold the layered SOUND button, then press the main SOUND button repeatedly to cycle through the different sound variations.

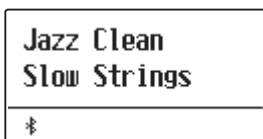

To layer two variations assigned to the same SOUND button:

Press and hold a SOUND button, then press the √ or ∧ VALUE buttons to select the layered sound variation.

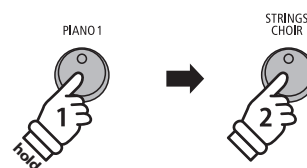
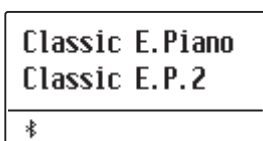

Example: To change the layered "String Ensemble" sound to the "Slow Strings" sound, press and hold the PIANO1 button, then press the STRINGS/CHOIR button.

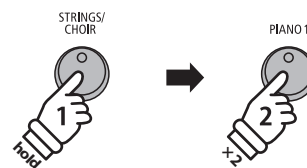

Example: To change the main "SK ConcertGrand" sound to the "Jazz Clean" sound, press and hold the STRINGS/CHOIR button, then press the PIANO1 button twice.

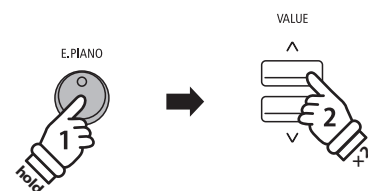

Example: To layer the "Classic E.P." and "60's E.Piano" sounds together, press and hold the E.PIANO button, then press the VALUE ∧ button twice.

* Preferred Dual mode sound combinations can be stored to a Registration memory for convenient recall. Please refer to page 37 for more information.

3. Adjusting the main/layered sound volume balance

While Dual mode is in use:

Press the ∇ or \wedge VALUE buttons to adjust the volume balance between the main and layered sounds.

The volume balance will briefly be shown in the display.

* The default Dual mode volume balance is 9-9.

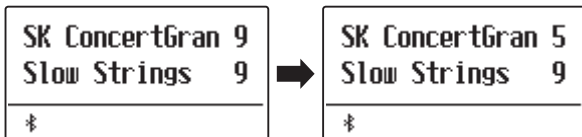

* The preferred Dual mode volume balance can also be stored to a Registration memory for convenient recall. Please refer to page 37 for more information.

* The Layer Octave Shift setting can be used to adjust the octave range of the layered sound. Please refer to page 82 for more information.

* The Layer Dynamics setting can be used to adjust the dynamic sensitivity of the layered sound. Please refer to page 83 for more information.

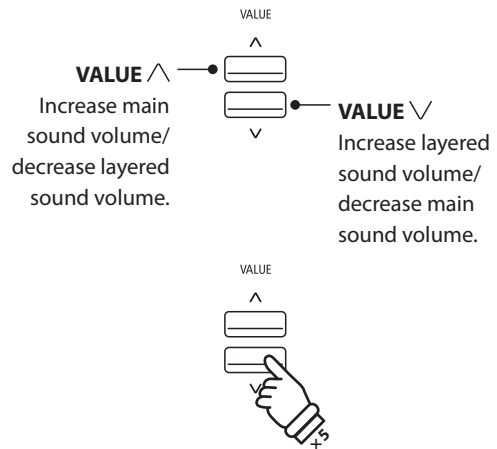

Example: To decrease the volume of the main sound to 5, press the VALUE ∇ button five times.

4. Exiting Dual mode

While Dual mode is in use:

Press a single SOUND button.

The LED indicator for the button will turn on, the name of the selected sound will be shown in the display, and the instrument will return to normal (single voice mode) operation.

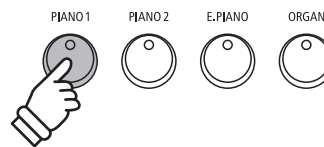

Split Mode

The Split Mode function divides the keyboard into two sections, allowing each section to be played with a different sound. For example, a bass sound in the lower section, and a piano sound in the upper section.

1. Entering Split mode

Press the SPLIT button.

The LED indicator for the SPLIT button will turn on and the keyboard is split at the point between F#3 and G3. G3 where the upper section begins, is called the split point.

The default split point is G3.

The LED indicator for the upper section sound button will turn on, and the LED indicator for the lower section sound button will start to flash. The respective sound names will also be shown in the display.

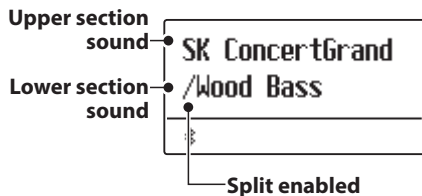
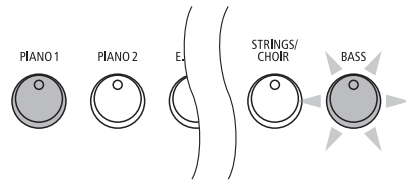

Default Split mode:

The previously selected sound is used for the upper section, and the "Wood Bass" sound is selected for the lower section.

2. Changing the upper/lower section sounds

To select a different sound for the upper section:

Press the desired SOUND button.

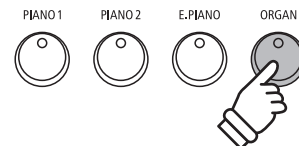
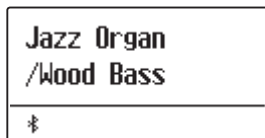

Example: To select the "Jazz Organ" sound for the upper section, press the ORGAN button.

To select a different sound for the lower section:

Press and hold the SPLIT button, then press the desired SOUND button.

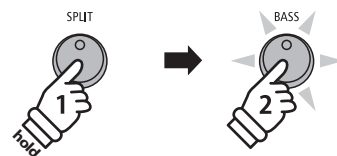
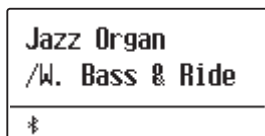

Example: To select the "W. Bass & Ride" sound for the lower section, press and hold the SPLIT button, then press the BASS button.

- * The Lower Octave Shift setting can be used to adjust the octave range of the lower section. Please refer to page 80 for more information.
- * The Lower Pedal setting can be used to enable/disable the damper pedal for the lower section. Please refer to page 81 for more information.
- * Preferred Split mode upper/lower sound combinations can be stored to a Registration memory for convenient recall. Please refer to page 37 for more information.

3. Changing the split point

Press and hold the SPLIT button, then press the desired split key on the keyboard.

The name of the pressed key will briefly be shown in the display, and will become the new split point.

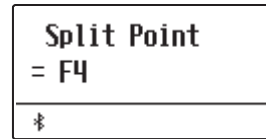

Example: To set the split point to key F4, press and hold the SPLIT button, then press the F4 key.

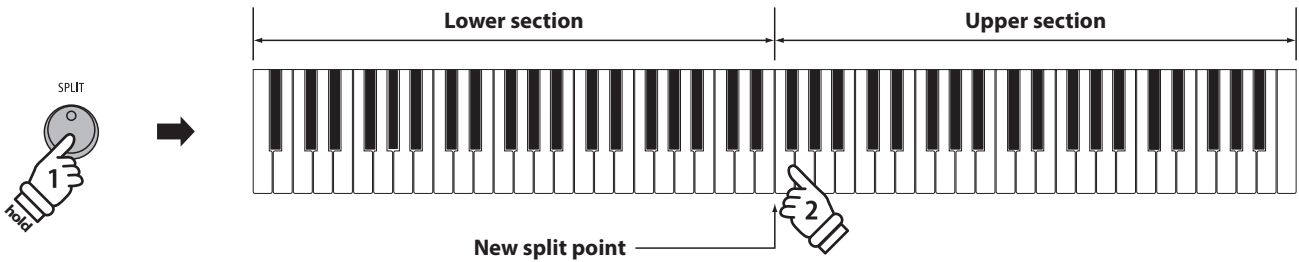

4. Adjusting the upper/lower sound volume balance

While Split mode is in use:

Press the ∇ or \blacktriangle VALUE buttons to adjust the volume balance between the upper and lower sections.

The volume balance will briefly be shown in the display.

* The default Split mode volume balance is 9-9.

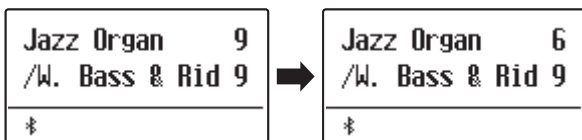

* The preferred Split mode upper/lower volume balance can also be stored to a Registration memory for convenient recall. Please refer to page 37 for more information.

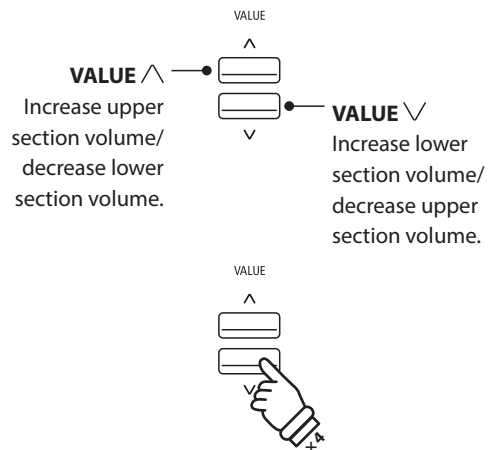

Example: To decrease the volume of the upper section sound to 6, press the VALUE ∇ button four times.

5. Exiting Split mode

While Split mode is in use:

Press the SPLIT button.

The LED indicator for the SPLIT button will turn off, and the instrument will return to normal (full keyboard) operation.

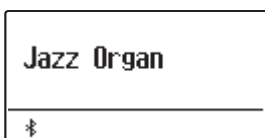

Four Hands Mode

The Four Hands Mode function divides the keyboard into two sections in a similar way to that of the Split Mode function. However, with Four Hands Mode enabled, the octave/pitch of each section is automatically adjusted to create two separate 44-key instruments with the same playing range. This function is intended to allow two people to practise together or perform piano duets using a single instrument.

1. Entering Four Hands mode

Press and hold the SPLIT button, then press the damper pedal.

The LED indicator for the SPLIT button will start to flash to indicate that Four Hands mode is in use.

* The default four hands mode split point is set between keys E4 and F4.

The LED indicator for the PIANO1 button will turn on, and the "SK ConcertGrand" sound will automatically be selected for both the upper and lower sections.

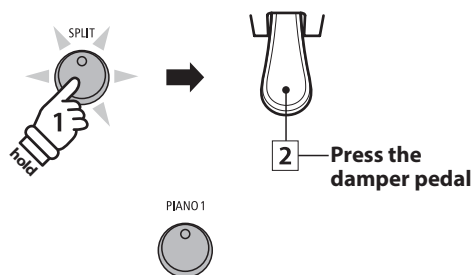

Default Four Hands mode:
The "SK ConcertGrand" sound is selected for both the upper and lower sections.

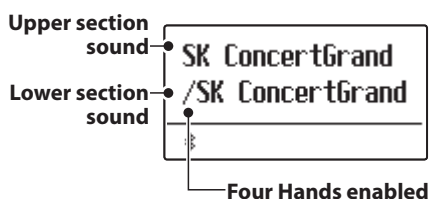

2. Changing the upper/lower section sounds

To select a different sound for the upper section:

Press the desired SOUND button.

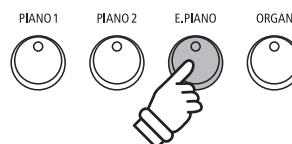

Example: To select the "Classic E.P." sound for the upper section, press the E.PIANO button.

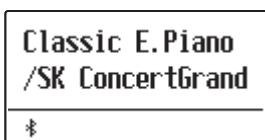

To select a different sound for the lower section:

Press and hold the SPLIT button, then press the desired SOUND button.

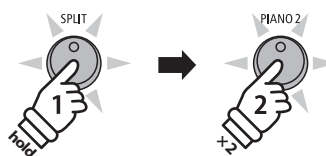

Example: To select the "Upright Piano" sound for the lower section, press and hold the SPLIT button, then press the PIANO2 button twice.

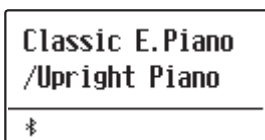

* If the included F-10H foot pedal is connected to the instrument, the pedal will function as a damper pedal for the upper section only. However, if the optional GFP-3 or F-302 triple pedal is connected, the right (sustain) and left (soft) pedals will function as independent damper pedals for the upper and lower sections respectively.

* Preferred Four Hands mode upper/lower sound combinations can be stored to a Registration memory for convenient recall. Please refer to page 37 for more information.

3. Changing the Four Hands mode split point

Press and hold the SPLIT button, then press the desired split key on the keyboard.

The name of the pressed key will briefly be shown in the display, and will become the new Four Hands mode split point.

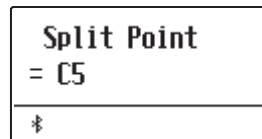

Example: To set the split point to key C5, press and hold the SPLIT button, then press the C5 key.

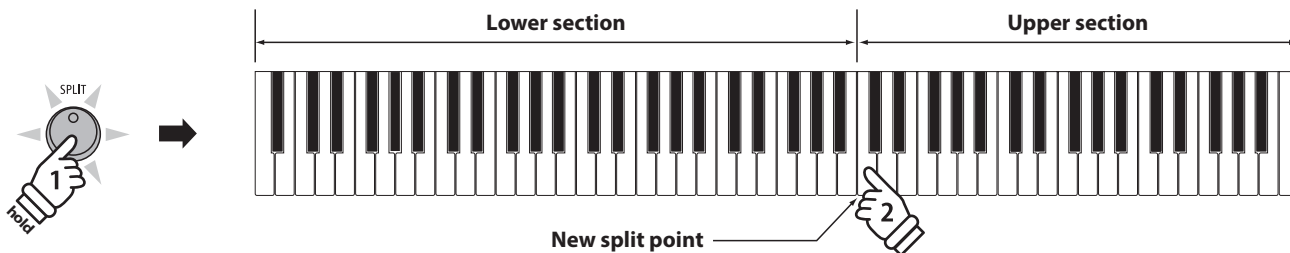

4. Adjusting the upper/lower sound volume balance

While Four Hands mode is in use:

Press the ∇ or \blacktriangle VALUE buttons to adjust the volume balance between the upper and lower sections.

The volume balance will briefly be shown in the display.

* The default Four Hands mode volume balance is 9-9.

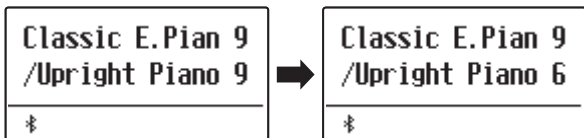

* The preferred Four Hands mode upper/lower volume balance can also be stored to a Registration memory for convenient recall. Please refer to page 37 for more information.

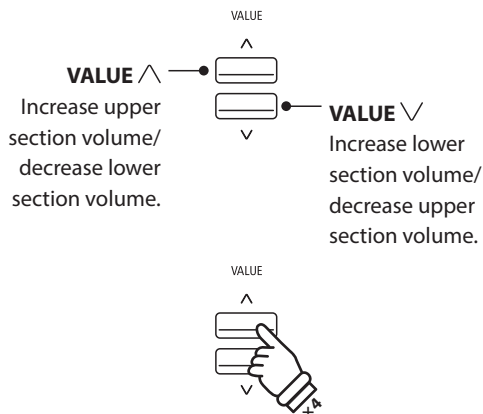

Example: To decrease the volume of the lower section sound to 6, press the VALUE \blacktriangle button four times.

5. Exiting Four Hands mode

While Four Hands mode is in use:

Press the SPLIT button.

The LED indicator for the SPLIT button will stop flashing, and the instrument will return to normal (full keyboard) operation.

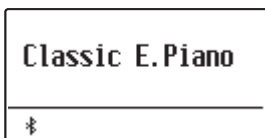

Enhancing the Sound

The ES520 digital piano offers a variety of features to adjust and enhance the character of a particular sound. Some of these features (e.g. Reverb), are enabled automatically when a sound is selected, however players may also wish to change the strength or type of enhancement to suit their personal preferences or different styles of music.

1 Reverb

Reverb adds reverberation to the sound, simulating the acoustic environment of a recital room, stage, or concert hall. Some sound types, such as acoustic piano, enable reverb automatically in order to improve acoustic realism. The ES520 digital piano features six different reverb types.

■ Reverb types

Reverb type	Description
Room	Simulates the ambience of a small rehearsal room.
Lounge	Simulates the ambience of piano lounge.
Small Hall	Simulates the ambience of a small hall.
Concert Hall	Simulates the ambience of a concert hall or theater.
Live Hall	Simulates the ambience of a live hall or stage.
Cathedral	Simulates the ambience of a large cathedral.

1. Turning Reverb on/off

Press the REVERB button to turn reverb on/off.

The LED indicator for the REVERB button will turn on to indicate when reverb is in use, and the current status will briefly be shown in the display.

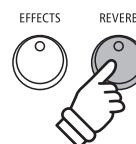

2. Entering the Reverb settings menu

Press and hold the REVERB button.

The reverb settings menu will be shown in the display.

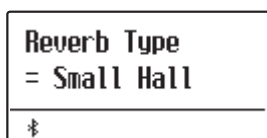
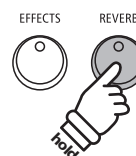

■ Reverb settings

Reverb setting	Description	Range
Type	Changes the type of environment.	–
Depth	Adjusts the depth of the environment (i.e. amount of reverberation to apply).	1~10
Time	Adjusts the decay length/speed of the reverberation.	1~10

3. Adjusting the Reverb settings (type/depth/time)

While the reverb settings menu is shown, to change the reverb type:

Press the ∇ or \wedge VALUE buttons to cycle through the different reverb types.

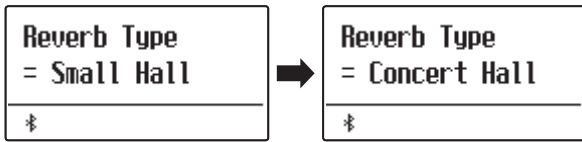

Example: To change the reverb type from “Small Hall” to “Concert Hall”, press the VALUE \wedge button.

To change the reverb depth:

Press the ∇ or \wedge MENU buttons to select the “Reverb Depth” page, then press the ∇ or \wedge VALUE buttons to decrease or increase the reverb depth setting.

* The reverb depth setting can be adjusted within the range of 1~10.

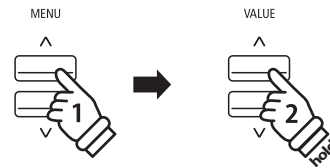
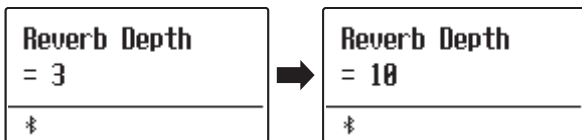

Example: To increase the reverb depth, press the MENU \wedge button to select the “Reverb Depth” page, then press and hold the VALUE \wedge button.

To change the reverb time:

Press the ∇ or \wedge MENU buttons to select the “Reverb Time” page, then press the ∇ or \wedge VALUE buttons to decrease or increase the reverb time setting.

* The reverb time setting can be adjusted within the range of 1~10.

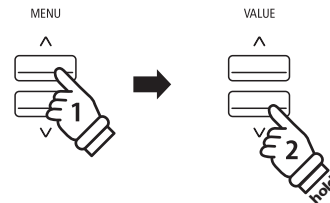
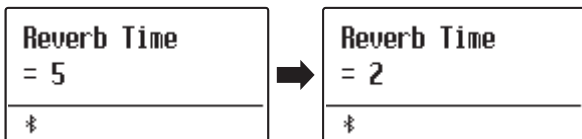

Example: To reduce the reverb time, press the MENU \wedge button to select the “Reverb Time” page, then press and hold the VALUE ∇ button.

To exit the reverb settings menu and return to normal playing mode, press the EXIT button or wait 10 seconds.



- * Reverb settings are independent for each sound variation.
- * Any changes made to the reverb type, settings, or on/off status will remain until the power is turned off.
- * Preferred reverb settings can be stored to a Registration memory for convenient recall. Please refer to page 37 for more information.

2 Effects

In addition to reverb, various other effects can be applied to the selected sound, altering the tonal character and feeling of the instrument. As with reverb, some sound types enable certain effects automatically in order to enhance tonal quality. The ES520 digital piano features 16 different effect types.

Effect types

Effect type	Description
Mono Delay	Adds an echo effect to the sound, playing through both speakers (stereo) simultaneously.
Ping Delay	Adds a "ping pong" echo effect to the sound, giving the impression that it is "bouncing" from left to right.
Triple Delay	Similar in principle to Ping Delay, but with an additional centre echo.
Chorus	Layers a slightly detuned version of the sound over the original, thus enriching its tonal character.
Classic Chorus	Similar in principle to Chorus, but intended for vintage electric piano sounds.
Ensemble	Enriches the sound by adding three voiced chorus.
Tremolo	Adds a tremor to the sound by varying the volume constantly.
Classic Tremolo	Similar in principle to Tremolo, but intended for vintage electric piano sounds.
Vibrato Tremolo	Adds vibrato to tremolo.
Auto Pan	Alternates the sound output from left to right across the stereo field using a sine wave.
Classic Auto Pan	Similar in principle to Auto Pan, but intended for vintage electric piano sounds.
Phaser	Applies a cyclic phase change to the sound, giving the impression that the sound is moving.
Classic Phaser	Adds an effect produced by digital signal processing of classic chorus.
Compressor	Increases the acoustic pressure.
Rotary 1	Simulates the sound of a rotary speaker commonly used with vintage electronic organs. * Pressing the ∨ and ∧ MENU buttons simultaneously alternates the speed of the rotary simulation between "Slow" and "Fast" effect modes. If the optional GFP-3 or F-302 pedal is connected, the left (soft) pedal can also be used.
Rotary2	Adds vibrato to the rotary speaker effect.

1. Turning Effects on/off

Press the EFFECTS button to turn effects on/off.

The LED indicator for the EFFECTS button will turn on to indicate when effects are in use, and the current status will briefly be shown in the display.

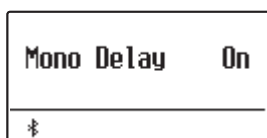
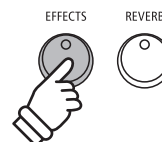

* If the Dual, Split, or Four Hands mode is selected, no effect is exerted on the layered sound or lower sound.

2. Entering the Effects settings menu, selecting the Effect type

Press and hold the EFFECTS button.

The first page of the effects settings menu will be shown in the display.

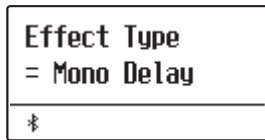

Press the ∇ or \blacktriangle VALUE buttons to cycle through the different effect types.

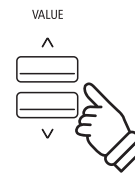
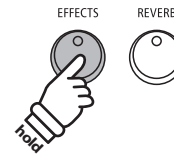

■ Effect settings

Effect type	Setting 1	Setting 2	Setting 3	Setting 4
Mono Delay / Ping Delay / Triple Delay	Dry / Wet	Time	Feedback	High Damp
Chorus	Dry / Wet	Speed	Feedback	Depth
Classic Chorus	Mono / Stereo	Speed	–	–
Ensemble	Dry / Wet	Speed	–	–
Tremolo	Dry / Wet	Speed	–	–
Classic Tremolo	Dry / Wet	Speed	–	–
Vibrato Tremolo	Dry / Wet	Speed	–	–
Auto Pan	Dry / Wet	Speed	–	–
Classic Auto Pan	Dry / Wet	Speed	–	–
Phaser	Dry / Wet	Speed	Feedback	Depth
Classic Phaser	Dry / Wet	Speed	Feedback	Depth
Compressor	Gain	Ratio	Threshold	Attack
Rotary 1	Accel. Speed	Rotary Speed	Lower Slow Speed	Upper Slow Speed
Rotary 2	Accel. Speed	Rotary Speed	Vibrato/Chorus	Spread

3. Selecting and adjusting the Effect settings

While the effects settings menu is shown in the display:

Press the ∇ or \wedge MENU buttons to cycle through the different effects settings pages.

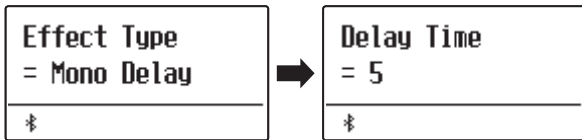

Press the ∇ or \wedge VALUE buttons to adjust the value of the selected effects setting.

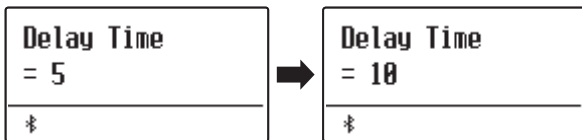

* Effect settings can be adjusted within the range from 1 to 10 except Compressor and Rotary 2(Vibrato/Chorus).

* Compressor settings are as follows.

- Gain (1 - 128)
- Ratio (1:1 - 64.5:1)
- Threshold (1 - 128)
- Attack (1 - 128)

* Rotary 2(Vibrato/Chorus) settings are as follows.

- Vibrato (V-1 ~ V-3)
- Chorus (C-1 ~ C-3)

To exit the effects settings menu and return to normal playing mode, press the EXIT button or wait 4 seconds.

* Effects settings are independent for each sound variation.

* Any changes made to the effect type, settings, or on/off status will remain until the power is turned off.

* Preferred effects settings can be stored to a Registration memory for convenient recall. Please refer to page 37 for more information.



Example: To select the "Delay Time" effects setting, press the MENU \wedge button twice.



Example: To increase the "Delay Time" effects setting, press and hold the VALUE \wedge button.



3 Amp Simulator

The ES520's Amp Simulator (Amp Sim) attempts to reproduce the sound, response, and overdrive characteristics of a typical amp/speaker combination, giving electric piano and drawbar organ sounds an authentic vintage quality. Once enabled, the amplifier type can be selected, with adjustable drive, level, and Low/Hi EQ settings. As with the Reverb and Effects functions, selecting certain sounds will enable the Amp Sim automatically.

1. Turning the Amp Sim on/off

Press the AMP button to turn the Amp Sim on/off.

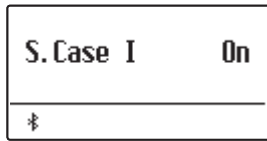

* If the Dual, Split, or Four Hands mode is selected, no effect is exerted on the layered sound or lower sound.

■ Amp Sim settings

Amp Sim setting	Description	Range
Type	Selects the amplifier/speaker type.	See below
Drive	Adjusts the drive (overdrive) level of the selected amplifier.	1~10
Level	Adjusts the volume level of the selected amplifier.	1~10
EQ Low	Adjusts the low frequency EQ level of the selected amplifier.	-6 dB~+6 dB
EQ High	Adjusts the high frequency EQ level of the selected amplifier.	-6 dB~+6 dB

2. Changing the Amp Sim type

While the Amp Sim settings menu is shown in the display:

Press and hold the AMP button. The Amp Sim settings menu will be shown in the display.

Press the \checkmark or \wedge VALUE buttons to cycle through the different Amp Sim types.

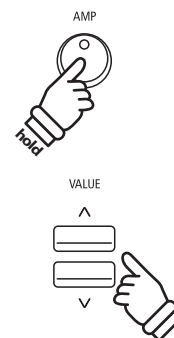
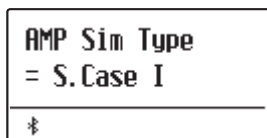

■ Amp Sim types

Amp Sim type	Description
S. Case I	A distantly miked suitcase type speaker, suitable for vintage electric piano sounds.
S. Case II	A closely miked suitcase type speaker, suitable for vintage electric piano sounds.
L. Cabinet	A speaker enclosed within a wooden cabinet, suitable for vintage drawbar organ sounds.

3. Adjusting the Amp Sim settings (drive/level/eq low/eq high)

While the Amp Sim settings menu is shown in the display:

Press the ∇ or \wedge MENU buttons to cycle through the different Amp Sim settings pages, then press the ∇ or \wedge VALUE buttons to adjust the value of the selected Amp Sim setting.

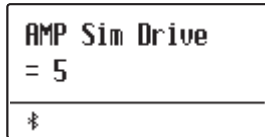

To exit the Amp Sim settings menu and return to normal playing mode, press the EXIT button or wait 4 seconds.

- * Amp Sim settings are independent for each sound variation.
- * Any changes made to the Amp Sim type, settings, or on/off status will remain until the power is turned off.
- * Preferred Amp Sim settings can be stored to a Registration memory for convenient recall. Please refer to page 37 for more information.

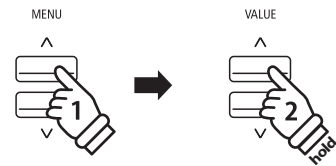

Example: To increase the drive of the Amp Sim, press the MENU \wedge button to select the "Amp Sim Drive" page, then press and hold the VALUE \wedge button.

Panel Lock

The Panel Lock function allows the state of all panel buttons to be temporarily locked, preventing sounds and other settings from being changed. This function may prove useful in teaching environments, ensuring that students are not distracted by changing sounds etc.

1. Activating the Panel Lock

Press the METRONOME and USB buttons simultaneously.

The Panel Lock screen will be shown in the display, and the instrument will stop responding to panel button presses.

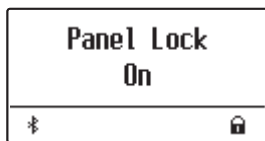
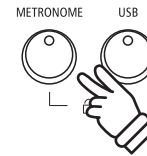

If panel buttons are pressed while the Panel Lock is activated, a reminder message will briefly be shown in the display.

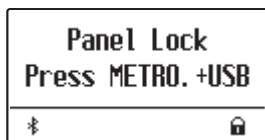

2. Deactivating the Panel Lock

Press the METRONOME and USB buttons simultaneously again.

A message will be shown in the display to indicate that the Panel Lock has been deactivated, and the instrument will resume responding to panel button presses as normal.

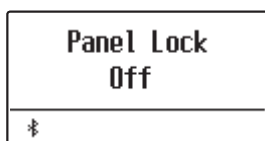
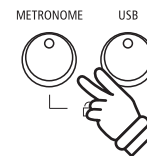

Transpose

The Transpose function allows the pitch of the ES520 digital piano's keyboard to be raised or lowered in semi-tone intervals. This is particularly useful when accompanying instruments tuned for different keys, or when a song learned in one key must be played in another key.

- * Changes are applied to all built-in sounds.
- * Any changes made by this operation will remain until the power is turned off. Preferred settings can be stored in a Registration memory or Startup Setting. Please refer to page 37 and 58 for more information.

■ Adjusting the Key Transpose value: Method 1

Press the TRANSPOSE button, then press the ∇ or \blacktriangle VALUE buttons to adjust the key transpose value.

The LED indicator for the TRANSPOSE button will turn on to indicate that the transpose function is in use, and the key transpose value will briefly be shown in the display.

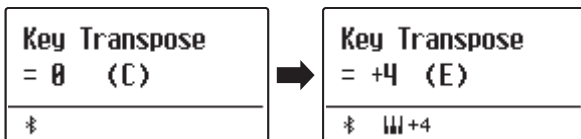

- * The keyboard pitch can be raised or lowered by up to 12 semi-tones.
- * To reset the key transpose value to 0, press and hold the TRANSPOSE button, then press the ∇ and \blacktriangle VALUE buttons simultaneously.

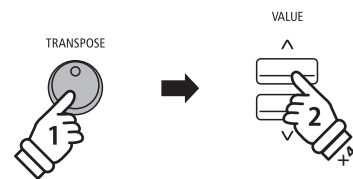

Example: To increase the key transpose value from 0 (off) to +4 (i.e. raise the keyboard pitch by 4 semi-tones), press and hold the TRANSPOSE button, then press the VALUE \blacktriangle button four times.

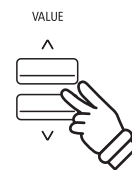

■ Adjusting the Key Transpose value: Method 2

Press and hold the TRANSPOSE button, then press a key within the range of C3 to C5 to specify the value between -12 and +12.

The LED indicator for the TRANSPOSE button will turn on to indicate that the transpose function is in use, and the key transpose value will briefly be shown in the display.

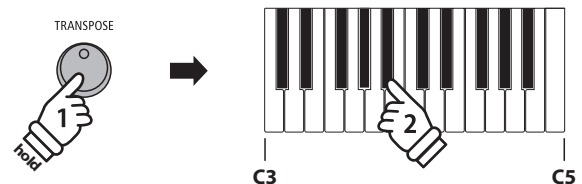
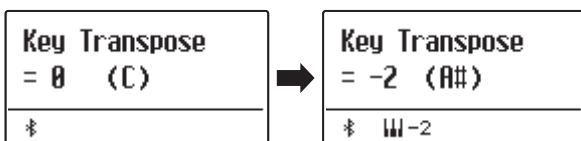

Example: To change the key transpose from C (off) to A (i.e. lower the keyboard pitch by three semi-tones), press and hold the TRANSPOSE button, then press the A# key.

■ Turning Key Transpose on/off

Press the TRANSPOSE button to turn the key transpose function on/off.

- * The specified key transpose setting will be retained even after the key transpose function is turned off. This allows the key transpose function to be turned on and off freely, without the need to adjust the value each time.
- * The specified key transpose setting will return to the default value of 0 after the power is turned off.
- * Preferred key transpose settings can be stored to a Registration memory for convenient recall. Please refer to page 37 for more information.



Metronome

The Metronome function provides a steady beat to aid practicing the piano at a consistent tempo. The time signature, volume, and tempo of the metronome can all be freely adjusted.

1. Turning the Metronome on/off

Press the METRONOME button.

The LED indicator for the METRONOME button will turn on to indicate that the metronome function is in use, and a 4/4 beat will start to count.



The current metronome tempo in beats per minute (BPM) and beat of the bar will also be shown in the display.

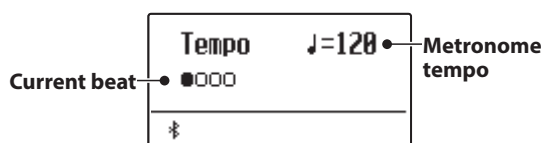

Press the EXIT or METRONOME button again to stop the metronome.

The LED indicator for the METRONOME button will turn off, the beat will stop counting, and the display will return to the normal playing mode screen.



2. Adjusting the Metronome settings (tempo/beat)

While the Metronome tempo screen is shown in the display, to adjust the metronome tempo:

Press the ∇ or \blacktriangle VALUE buttons to adjust the value of the metronome tempo.

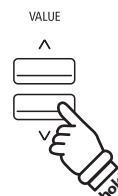
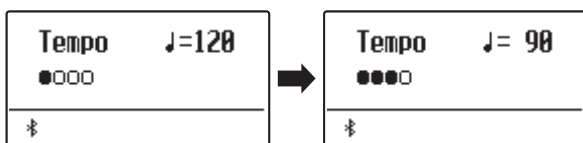

Example: To decrease the tempo of the metronome, press and hold the VALUE ∇ button.

* The metronome tempo can be adjusted within the range of 10~300 beats per minute (BPM).

* To reset the metronome tempo to 120, press the ∇ and \blacktriangle VALUE buttons simultaneously.

To adjust the metronome beat (time signature):

Press the ∇ or \blacktriangle MENU buttons to select the "Beat" page, then press the ∇ or \blacktriangle VALUE buttons to cycle through the different metronome beat (time signature) types.

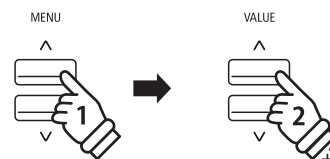

Example: To change the beat (time signature) from 1/4 to 3/4, press the MENU \blacktriangle button to select the "Beat" page, then press the VALUE \blacktriangle button twice.

* There are ten different types of beat (time signature) available:

1/4, 2/4, 3/4, 4/4, 5/4, 3/8, and 6/8.

* To reset the metronome beat to 4/4, press the ∇ and \blacktriangle VALUE buttons simultaneously.

Metronome

2. Adjusting the Metronome settings (volume)

To adjust the metronome volume:

Press the ∇ or \wedge MENU buttons to select the "Volume" page, then press the ∇ or \wedge VALUE buttons to adjust the value of the metronome volume.

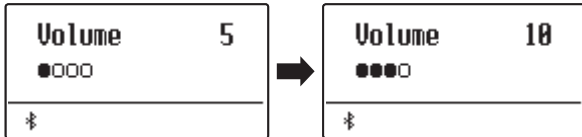

- * The metronome volume can be adjusted within the range of 1~10.
- * To reset the metronome volume to 5, press the ∇ and \wedge VALUE buttons simultaneously.

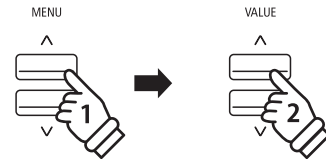

Example: To increase the volume of the tempo, press the MENU \wedge button to select the "Volume" page, then press the VALUE \wedge button.

■ Jump to Recorder shortcut

While the Metronome function is in use:

Press the ● (REC) button.

The Recorder standby screen will be shown in the display, and the metronome will count. A one bar count-in will also be played before the recording begins.

- * Please refer to page 39 for more information about the instrument's Recorder functions.

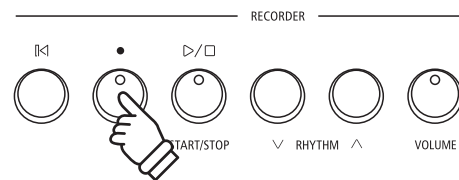

Rhythm

As an alternative to regular metronome beats, the ES520 digital piano also features a variety of drum rhythms to accompany most playing styles and musical genres.

■ Turning the Rhythm on/off

Press the RHYTHM button.

The LED indicator for the RHYTHM button will turn on to indicate that the Rhythm function is in use, and a drum pattern will start to play.

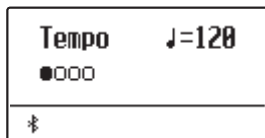

Press the ∇ or ▲ RHYTHM buttons to select the desired rhythm type.



Press the RHYTHM button again to stop the rhythm. The LED indicator for the RHYTHM button will turn off.

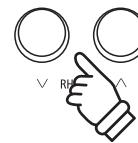

■ Adjusting the Rhythm tempo

Press the RHYTHM button.

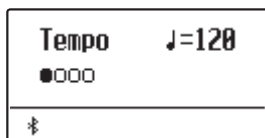

Press the ∇ or ▲ MENU buttons to select "Tempo", then press the ∇ or ▲ VALUE buttons to adjust the value of the Rhythm tempo.

* The tempo can be adjusted within the range of 10~300 beats per minute (BPM).

* To reset the tempo to 120, press the ∇ and ▲ VALUE buttons simultaneously.

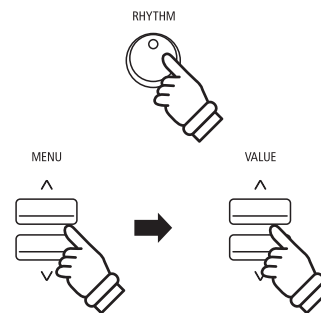

■ Changing the Rhythm pattern

Press the RHYTHM button.

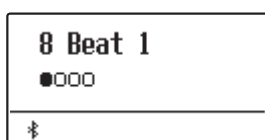

Press the ∇ or ▲ MENU buttons to select "Rhythm", then press the ∇ or ▲ VALUE buttons to select the desired Rhythm type.

* 100 types of rhythm patterns are available as choices.

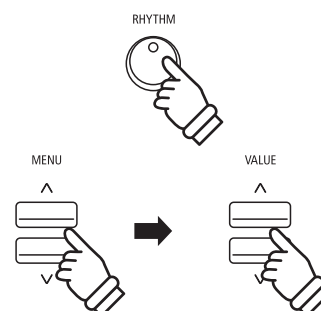

■ Adjusting the Rhythm volume

Press the RHYTHM button.

Press the ∇ or \wedge MENU button to select "Volume", then press the ∇ or \wedge VALUE buttons to adjust the rhythm volume.

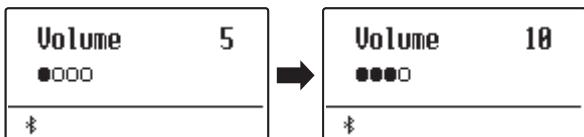

* The volume can be adjusted within the range of 1~10.

* To reset the volume to 5, press the ∇ and \wedge VALUE buttons simultaneously.

* To directly display the volume adjustment screen, press the VOLUME button.

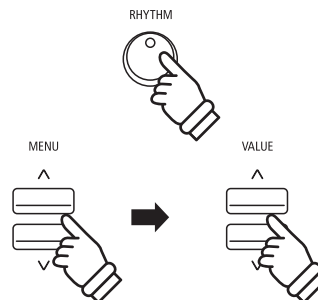

Registration Memories

The Registration function allows the current instrument setup (sound/style selection, all settings, etc.) to be stored to a registration memory, and conveniently recalled at the touch of a button. Each of the seven registration buttons contain four banks (A, B, C, and D), allowing up to 28 different registration memories to be stored.

Registrations can also be loaded from/saved to USB memory devices. Please refer to page 46 for more information.

■ Settings stored in Registration memories

General	Settings
Selected sound	Basic Settings*
Dual Mode / Split Mode (sounds, volume balance, split point)	Virtual Technician
Reverb, Effects, Amp Simulator (type, settings)	Key Settings
Transpose (Key Transpose only)	MIDI Settings

* Auto Display Off and Auto Power Off will not be stored to Registration memories.

■ Selecting a Registration memory

Press the REGISTRATION button.

The LED indicator for the REGISTRATION button will turn on to indicate that the registration function is in use, and the registration selection screen will be shown in the display.

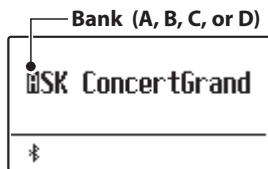

Press the SOUND buttons to select the desired registration memory. Press the same SOUND button repeatedly to cycle through the four banks (A, B, C, and D).

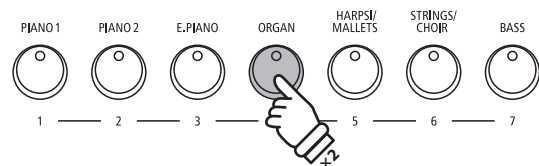

Example: To select registration memory 4B, press the ORGAN button (memory #4) twice.

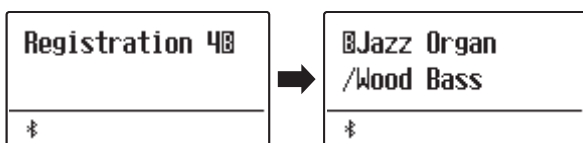

Alternatively, press the √ or ^ VALUE buttons to cycle through all 28 different registration memories.

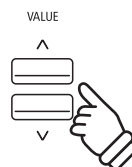

■ Exiting Registration mode (restore previous settings)

To return to normal playing mode without selecting the registration (i.e. restore the previous panel settings):

Press the REGISTRATION button.

The LED indicator for the REGISTRATION button will turn off, and the instrument will return to normal playing mode.



Registration Memories

■ Exiting Registration mode (retain new settings)

To return to normal playing mode with the current registration memory settings selected:

Press the EXIT button.

The LED indicator for the REGISTRATION button will turn off, and the instrument will return to normal playing mode.



■ Storing a Registration memory

To store a registration memory to the current banks (e.g. bank A):

Press and hold the REGISTRATION button, then press and hold a SOUND button.

The current instrument setup will be stored to the registration memory assigned to the pressed SOUND button, and a confirmation message will briefly be shown in the display.

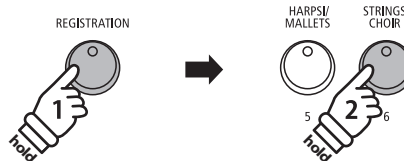
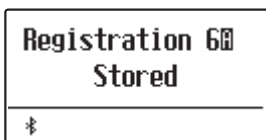

Example: To store the current instrument setup to memory 6A, press and hold the REGISTRATION button, then press and hold the STRINGS/CHOIR button.

To store a registration memory to a different banks (e.g. bank D):

Press and hold the REGISTRATION button, press the same SOUND button repeatedly to cycle through the four banks (A, B, C, and D), then press and hold the SOUND button.

* The \vee or \wedge VALUE buttons can also be used to change the bank.

The current instrument setup will be stored to the registration memory and bank specified, and a confirmation message will be briefly shown in the display.

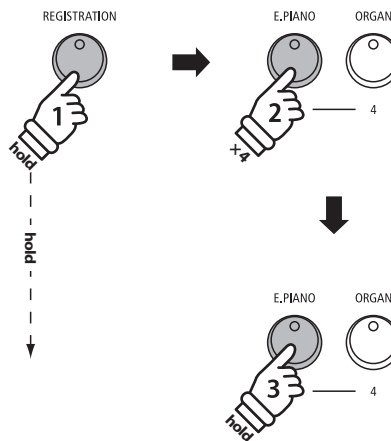
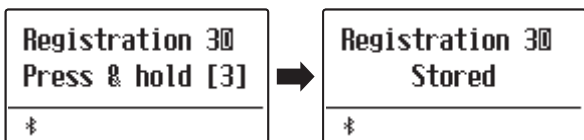

Example: To store the current instrument setup to memory 3D, press and hold the REGISTRATION button, press the E.PIANO button four times, then press and hold the same E.PIANO button.

■ Resetting all Registration memories

Press and hold the SPLIT and REGISTRATION buttons, then turn the instrument's power off/on.

All registration memories will be reset to the factory default settings.

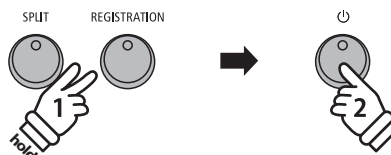

Song Recorder (Internal memory)

The ES520 digital piano allows up to 3 different songs to be recorded, stored in internal memory, and played back at the touch of a button.

1 Recording a Song

1. Entering song recorder mode

Press the ● (REC) button.

The LED indicator for the ● (REC) button will start to flash, and the Internal Song Recorder screen will be shown in the display.

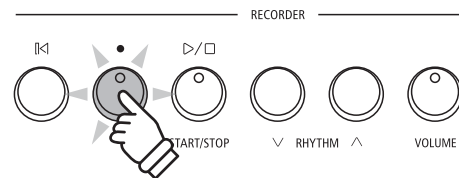
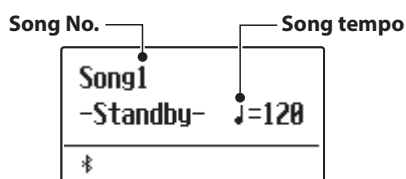

* If a USB memory device is connected, press the MENU ∧ button to select the "Int. Recorder" function.

* The Recorder shares the song tempo setting with the Metronome.

2. Selecting the song to be recorded

Press the ∨ or ∧ RHYTHM buttons to select the internal song memory (1~3) to be recorded to.

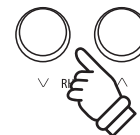
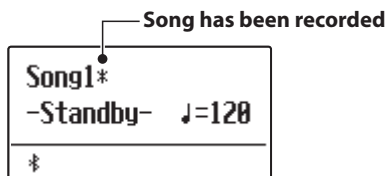

3. Starting the song recorder

Recording starts when the instrument is played.

The LED indicators for the ● (REC) and PLAY/STOP buttons will turn on, and recording will start.

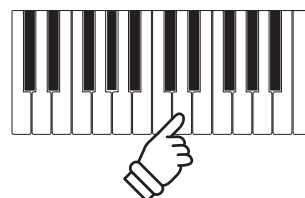
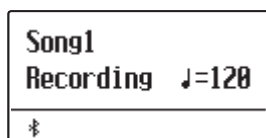

or



* Recording can also be started by pressing the PLAY/STOP button, allowing a rest period or empty bar to be inserted at the beginning of the song.

Song Recorder (Internal memory)

4. Stopping the song recorder

Press the PLAY/STOP button.

The LED indicators for the PLAY/STOP and ● (REC) buttons will turn off, the recorder will stop, and the song will be stored in internal memory.

After a few seconds, the Internal Song Player screen will be shown in the display, indicating that the song is ready for playback.

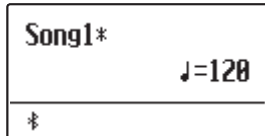
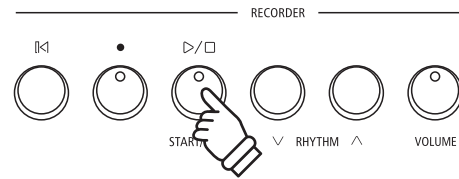

- * The maximum recording capacity is approximately 10,000 notes, with button and pedal presses also counted as one note.
- * If the maximum recording capacity is reached during recording, the recorder will stop automatically.
- * Recorder songs will remain in memory after the power is turned off.

Recording with the metronome/rhythm

It is also possible to record songs with the metronome/rhythm activated. This is useful when wishing to maintain correct timing throughout complex passages. Note that the metronome/rhythm will not be heard when the song is played back.

* Please refer to pages 33 and 35 for more information about using the instrument's Metronome function with the Recorder.

Changing panel settings while recording

In some cases, it may be desirable to make changes to the selected sound or style while recording a song. The tables below list the various functions which will and will not be remembered during recording.

Panel operations remembered during recording

- Changes made to the sound type. (SOUND buttons etc.)
- Switching between dual/split modes.

Panel operations NOT remembered during recording*

- Changes made to the reverb settings.
- Changes made to the effects settings.
- Changes made to the tempo.
- Changes made to the volume balance in dual/split mode.
- Changes made to transpose, tuning, touch, etc.

* Make changes to desired effects, reverb, and tempo settings etc. before recording a new song.

5. Exiting song recorder mode

Press the EXIT button to exit the Internal Song Recorder.

The instrument will return to normal playing mode.

EXIT



2 Playing a Song

This function is used to playback songs stored in the internal recorder. To playback a song immediately after recording, start this process from step 2.

1. Entering song play mode

Press the PLAY/STOP button.

The LED indicator for the PLAY/STOP button will turn on, and the Internal Song Player screen will be shown in the display.

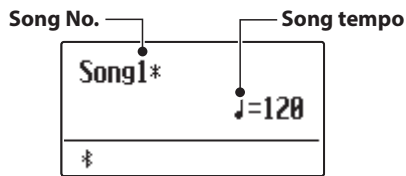

* If a USB memory device is connected, press the MENU \wedge button to select the "Int. Recorder" function.

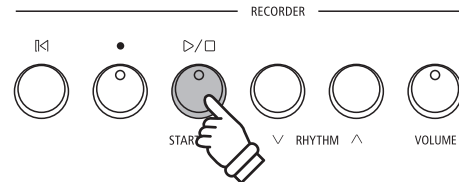

2. Selecting the song to be played back

Press the \vee or \wedge RHYTHM buttons to select the internal song memory (1~3) to be played back.

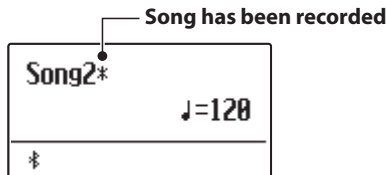

* If a song has already been recorded, a \star symbol will be shown.

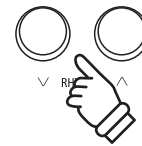

3. Starting song playback

Press the PLAY/STOP button.

The selected song will start to play, and the current bar and beat will also be shown in the display.

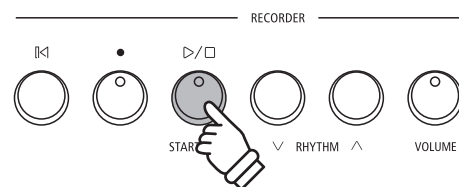
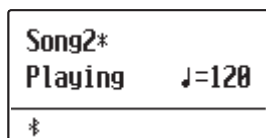

Song Recorder (Internal memory)

■ Controlling song playback

While the song is playing:

Press the PLAY/STOP button to pause and resume song playback.



Press the RESET button to return to the beginning of the song.



■ Adjusting the playback tempo

While the song is playing:

Press the ∨ or ∧ VALUE buttons to adjust the playback tempo.

* The playback tempo can be adjusted within the range of 10~300 beats per minute (BPM).

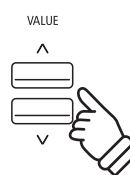

4. Exiting song play mode

Press the EXIT button to exit the Internal Song Player.

The instrument will return to normal playing mode.

* Press the EXIT button twice if a USB memory device is connected.



3 Erasing a Song

This function is used to erase songs that have been recorded incorrectly or songs that are no longer listened to. Once a song has been erased from memory it cannot be recovered.

1. Entering song erase mode

Press the ● (REC) and PLAY/STOP buttons simultaneously.

The LED indicators for the ● (REC) and PLAY/STOP buttons will start to flash, and the Erase Song screen with the currently selected song will be shown in the display.

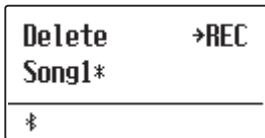
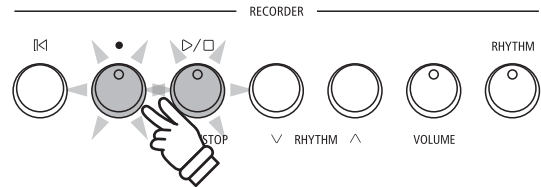

2. Selecting a song to be erased

Press the ∨ or ∧ RHYTHM buttons to select the internal song memory (1~3) to be erased.

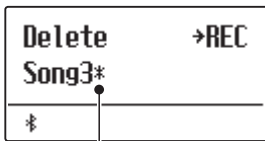
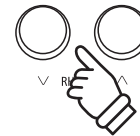

— Songs have been recorded

3. Erasing the selected song

Press the ● (REC) button.

A confirmation message will be shown in the display, prompting to confirm or cancel the erase operation.

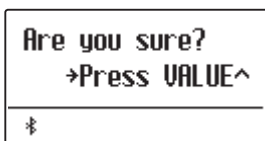
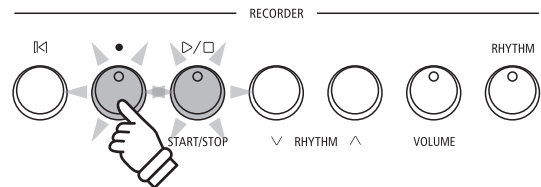

Press the VALUE ∧ button to confirm the erase operation and return to the Internal Song Player screen.

Press the EXIT button to cancel the erase operation.

* If cancelled, press the PLAY/STOP button to return to the Play Internal screen, or ● (REC) button to return to the Record Internal screen.

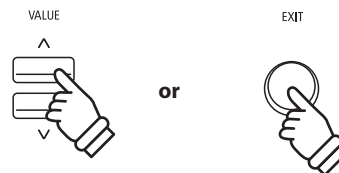

■ Erasing all recorder songs from memory

Press and hold the PLAY/STOP and ● (REC) buttons, then turn the instrument's power off/on.

All recorder songs stored in memory will be erased.

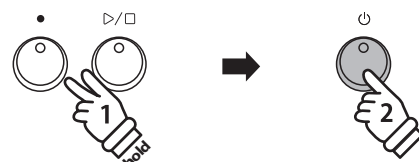

Playing a MIDI or KSO file (USB memory)

The ES520 digital piano also supports the playback of Standard MIDI File (SMF) and KSO file songs stored on a USB memory device, allowing a vast selection of widely accessible music to be heard through the instrument's exquisite Progressive Harmonic Imaging sound engine.

■ Song Player supported format specifications

Song Format	Specifications
MID	Format 0, Format 1
KSO	Internal song format

■ Preparing the USB memory device

First, prepare a selection of MID (SMF) song files, copying the data to a USB memory device.



1. Entering USB playback mode

Connect a USB memory device to the USB port.

Press the PLAY/STOP button, then press the MENU ∇ button to select the "USB Player" function.

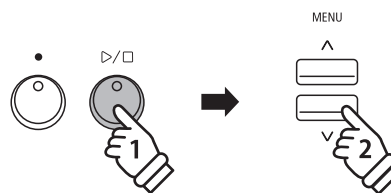

The file selection screen will be shown in the display.

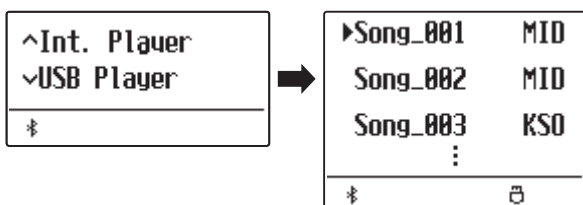

2. Selecting and playing a MIDI or KSO file.

Press the ∇ or \wedge VALUE buttons to move the selection cursor, then press the MENU \wedge button to select the MIDI or KSO file.

Press the PLAY/STOP button.

The player screen will be shown in the display.

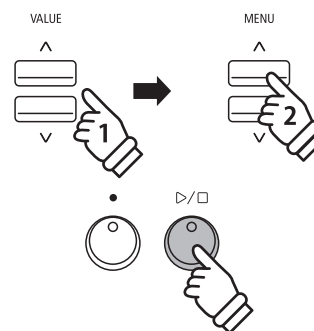
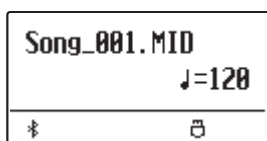

The LED indicator for the PLAY/STOP button will turn on and the selected song file will start to play.

* The ES520 digital piano does not contain the full General MIDI/GM2 sound bank selection. Consequently, some SMF song files may not be reproduced entirely accurately when played through the instrument.

■ Controlling MIDI file playback

While the MIDI file is playing:

Press the PLAY/STOP button to pause and resume playback.



Press the RESET button to return to the beginning of the MIDI file.



■ Adjusting the MIDI file playback tempo

Press the ∇ or \blacktriangle VALUE buttons to adjust the playback tempo.

* The playback tempo can be adjusted within the range of 10~300.

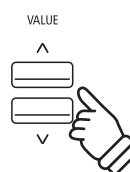

3. Exiting USB playback mode

Press the EXIT button to exit the USB Recorder.

The instrument will return to normal playing mode.



USB Menu

The USB Menu contains functions to load/save registration memories and recorder songs from/to a USB memory device. This menu also allows files to be renamed and deleted, and for the USB memory device to be formatted.

■ USB Menu functions

Page no.	Function	Description
1	Load Regist	Load the registration file from a USB memory device into the instrument.
2	Save INT Song	Save the song recorded in the instrument's internal memory to a USB memory device in KSO file format.
3	Save Regist	Save the registration set on the instrument to a USB memory device.
4	Rename File	Rename the name of a file stored in a USB memory device.
5	Delete File	Delete a file in a USB memory device.

1. Entering the USB Menu

Connect a USB memory device to the USB port.

Press the USB button.

The LED indicator for the USB button will turn on, and the first page of the USB Menu will be shown in the display.



2. Selecting the desired USB Menu function

Press the ∇ or \wedge MENU buttons to cycle through the different USB Menu function pages.

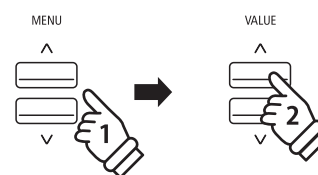

Press the VALUE \wedge button to select the function.

3. Exiting the USB Menu

Press the EXIT or USB button to exit the USB Menu.

The LED indicator for the USB button will turn off, and the instrument will return to normal playing mode.

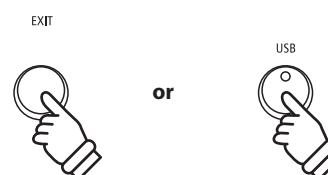

1 Load Registration

The Load Registration function is used to load registration memories stored on a USB memory device into the instrument's internal memory. There are two types of registration file: "Single" and "All".

■ Registration file types

Registration type	Description	File extension
Single	A file containing a single registration memory.	KM6
All	A file containing all 28 registration memories.	KM3

1. Selecting the Load Regist function

Connect a USB memory device, then press the USB button to enter the USB Menu.

Press the ∇ or \wedge MENU buttons then the VALUE \wedge button to select the Load Regist function.

The file selection screen will be shown in the display, listing the registration files stored on the USB memory device.

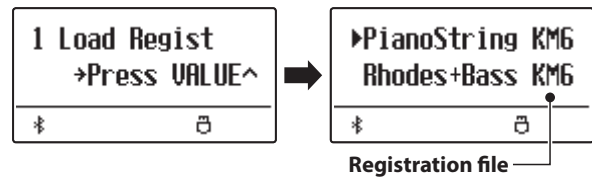

2. Selecting the registration file to be loaded

Press the ∇ or \wedge VALUE buttons to move the selection cursor, then press the MENU \wedge button to select the registration file.

The memory selection screen will be shown in the display.



3. Selecting the registration memory

Press the ∇ or \wedge VALUE buttons to select the registration memory for the registration to be loaded into.

* If an "All Registration" file is selected, this step will be skipped.

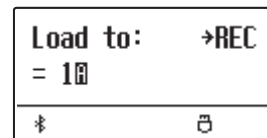

4. Loading the selected registration

Press the \bullet (REC) button to load the selected registration.

A confirmation message will be shown in the display.

Press the VALUE \wedge button to confirm the load operation. Press the EXIT button to cancel the load operation.

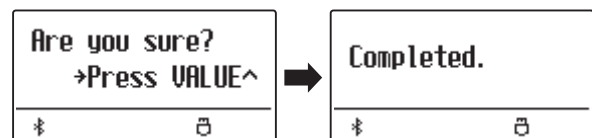

To use the loaded registration, please refer to the Registration instructions on page 37.

2 Save Internal Song

The Save Internal Song function is used to save recorder songs stored in the instrument's internal memory to a USB memory device in the ES520's native song format.

1. Selecting the Save Int. Song function

Connect a USB memory device, then press the USB button to enter the USB Menu.

Press the ∇ or \wedge MENU buttons then the VALUE \wedge button to select the Save Int. Song function.

The song selection screen will be shown in the display.

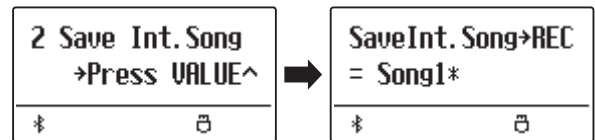

2. Selecting the song to be saved

Press the ∇ or \wedge VALUE buttons to select the internal song memory to be saved.

Press the ● (REC) button to continue.

The filename entry screen will be shown in the display.

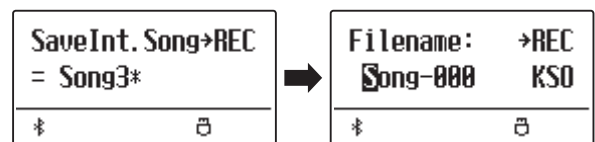

3. Naming the song

Press the ∇ or \wedge VALUE buttons to cycle through the characters, and the ∇ or \wedge MENU buttons to move the cursor.

- * Saved files are limited to a maximum name length of 11 characters.
- * The saved song will be stored in the root folder of the USB memory device.



4. Saving the song

Press the ● (REC) button again to save the recorded song with the specified filename.

A confirmation message will be shown in the display.

Press the VALUE \wedge button to confirm the save operation.
Press the EXIT button to cancel the save operation.

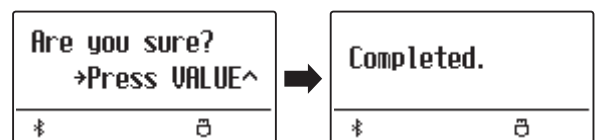

3 Save Registration

The Save Registration function is used to save registration memories stored in the instrument to a USB memory device. There are two types of registration file: "Single" and "All".

Registration file types

Registration type	Description	File extension
Single	A file containing a single registration memory.	KM6
All	A file containing all 28 registration memories.	KM3

1. Selecting the Save Regist function

Connect a USB memory device, then press the USB button to enter the USB Menu.

Press the ∇ or \wedge MENU buttons then the VALUE \wedge button to select the Save Regist function.

The memory selection screen will be shown in the display.

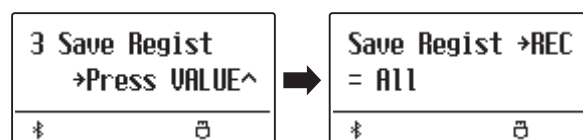

2. Selecting the registration memory to be saved

Press the ∇ or \wedge VALUE buttons to select the registration memory to be saved.

* The "All" option will save all registration memories to a single file.

Press the ● (REC) button to continue.

The filename entry screen will be shown in the display.

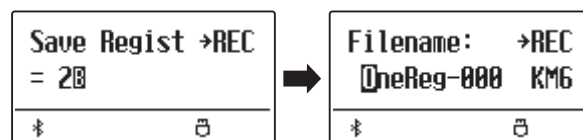

3. Naming the registration file

Press the ∇ or \wedge VALUE buttons to cycle through the characters, and the ∇ or \wedge MENU buttons to move the cursor.

* Saved files are limited to a maximum name length of 11 characters.

* The saved registration will be stored in the root folder of the USB memory device.

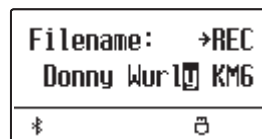

4. Saving the registration file

Press the ● (REC) button again to save the recorded registration with the specified filename.

A confirmation message will be shown in the display.

Press the VALUE \wedge button to confirm the save operation.
Press the EXIT button to cancel the save operation.

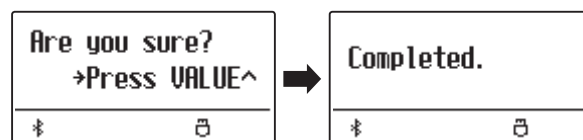

4 Rename File

The Rename File function is used to rename song (KSO) files and registration (KM6/KM3) files recorded with the ES520 digital piano and now stored on a USB memory device.

1. Selecting the Rename File function

Connect a USB memory device, then press the USB button to enter the USB Menu.

Press the ∇ or \wedge MENU buttons then the VALUE \wedge button to select the Rename File function.

The file selection screen will be shown in the display, listing song and registration files stored on the USB memory device.

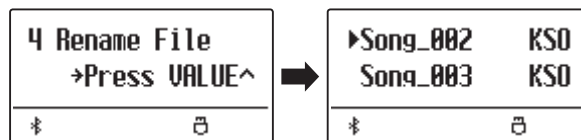

2. Selecting the file to be renamed

Press the ∇ or \wedge VALUE buttons to move the selection cursor, then press the MENU \wedge button to select the file.

The filename entry screen will be shown in the display.

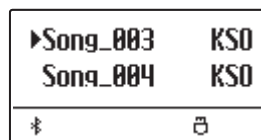

3. Renaming the selected file

Press the ∇ or \wedge VALUE buttons to cycle through the characters, and the ∇ or \wedge MENU buttons to move the cursor.

* Files are limited to a maximum name length of 11 characters.

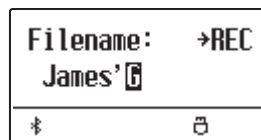

4. Confirming the rename

Press the \bullet (REC) button to rename the file.

A confirmation message will be shown in the display.

Press the VALUE \wedge button to confirm the rename operation.

Press the EXIT button to cancel the rename operation.

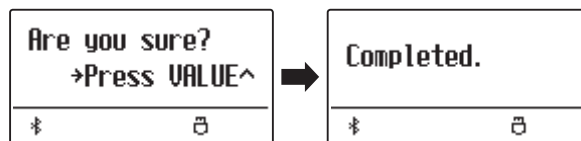

5. Exiting the Rename File function

Press the EXIT button to exit the Rename File function.

The LED indicator for the USB button will turn off, and the instrument will return to normal playing mode.

5 Delete File

The Delete File function is used to delete song (KSO) files and registration (KM6/KM3) files recorded with the ES520 digital piano and now stored on a USB memory device.

Once a file has been deleted from the USB device it cannot be recovered.

1. Selecting the Delete File function

Connect a USB memory device, then press the USB button to enter the USB Menu.

Press the ∇ or \wedge MENU buttons then the VALUE \wedge button to select the Delete File function.

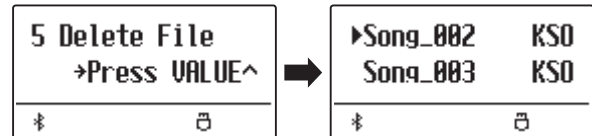

The file selection screen will be shown in the display, listing song and registration files stored on the USB memory device.

2. Selecting the file to be deleted

Press the ∇ or \wedge VALUE buttons to move the selection cursor, then press the MENU \wedge button to select the file.

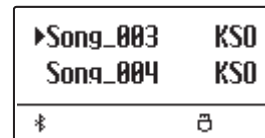

3. Confirming the delete

A confirmation message will be shown in the display.

Press the VALUE \wedge button to confirm the delete operation.
Press the EXIT button to cancel the delete operation.

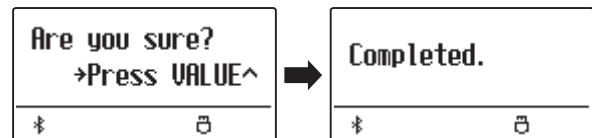

4. Exiting the Delete File function

Press the EXIT button to exit the Delete File function.

The LED indicator for the USB button will turn off, and the instrument will return to normal playing mode.

Settings Menu

The Settings menus contain a variety of options to adjust the ES520's operation and sound. Settings are grouped by category, providing convenient access to relevant controls. Once adjusted, settings can be stored to one of the instrument's 28 registration memories, or selected as the default power-on settings with the Startup Setting function.

■ Entering the Settings menus

While the normal playing mode screen is shown in the display:

Press the ∨ or ^ MENU buttons.

The first settings menu (Basic Settings) will be shown in the display.



Press the ∨ or ^ MENU buttons to cycle through the different settings menus, then press the VALUE ^ button to enter the selected menu.

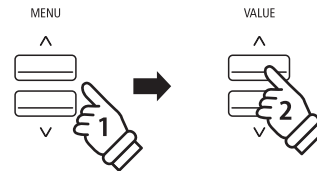
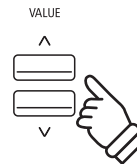

■ Exiting the Settings menus

Press the EXIT button to return to the main settings menu.

Press the EXIT button again to return to normal playing mode.



■ Overview of Settings menus

1. Basic Settings Tone Control, Tuning, Damper Hold, Four Hands, Startup Setting, Factory Reset, Auto Display Off, Auto Power Off	3. Key Settings Lower Octave Shift, Lower Pedal On/Off, Split Balance, Layer Octave Shift, Layer Dynamics, Dual Balance
2. Virtual Technician Touch Curve, Voicing, User Voicing, Damper Resonance, Damper Noise, String Resonance, Key-off Effect, Fall-back Noise, Hammer Delay, Topboard, Decay Time, Minimum Touch, Temperament, Stretch Tuning, Stretch Curve, Temperament Key, User Temperament, User Key Volume, Half-Pedal Adjust, Soft Pedal Depth	4. Phones Settings SHS Mode, Phones Type
	5. MIDI Settings
	6. Bluetooth Settings Bluetooth Audio, Bluetooth Audio Volume, Bluetooth MIDI

Basic Settings

The Basic settings menu contains settings to adjust the pitch, tuning, and general sound of the instrument. This menu also allows favourite panel settings to be stored, or reset back to the original factory configuration.

* Any changes made by this operation will remain until the power is turned off.
Preferred settings can be stored in a Registration memory or Startup Setting. Please refer to page 37 and 58 for more information.

Basic Settings

Page no.	Setting	Description	Default setting
1-1	Tone Control	Change the EQ settings of the instrument's sound.	Flat
1-2	Tuning	Increase or decrease the pitch of the instrument in 0.5 Hz steps.	440.0 Hz
1-3	Damper Hold	Change the effect of pressing the sustain pedal on organ, string, etc. sounds.	Preset
1-4	Four Hands	Enable the "Four Hands Mode" function.	Off
1-5	Startup Setting	Store current panel settings as the default (power-on) configuration.	-
1-6	Factory Reset	Restore all panel settings to the original factory configuration.	-
1-7	Auto Display Off	Turn off the display automatically after a period of time without any operations.	5 min.
1-8	Auto Power Off	Turn off the instrument automatically after a period of time without any operations.	-

Entering the Basic Settings menu

While the normal playing mode screen is shown in the display:

Press the ∇ or \wedge MENU buttons.

The Basic Settings page will be shown in the display.

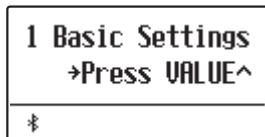

Press the VALUE \wedge button to enter the Basic Settings menu.

The first page of the Basic Settings menu will be shown in the display

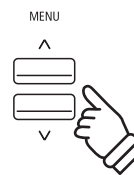

Selecting the desired setting

After entering the Basic Settings menu:

Press the ∇ or \wedge MENU buttons to cycle through the different settings pages.

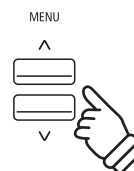
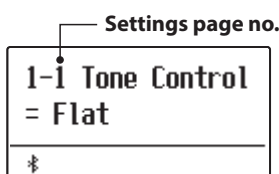

1-1 Tone Control

The Tone Control function allows the overall sound character of the ES520 digital piano to be adjusted to ensure the best sound quality within the area that the instrument is located. There are six different preset Tone Control types available, with an additional "User" setting allowing finer control over the different frequency bands.

* The tone (volume) set in this function is applied to the middle position of the sliders of 4-band equalizer on the panel.

■ Tone Control types

Tone Control type	Description
Flat (default)	The Tone Control is turned off, and the sound character is unchanged.
Brilliance	Adjust the overall brightness of the sound, independently of the "Voicing" Virtual Technician setting.
Bass Boost	Emphasises low-range frequencies, creating a deeper sound.
Bass Cut	Reduces bass-range frequencies.
Mid Boost	Emphasises mid-range frequencies, creating a slightly hard sound.
Loudness	Emphasises frequencies to retain the instrument's sound character when playing at low volume levels.
Bright	Emphasises dazzling brightness of the sound.
Mellow	Emphasises calm softness of the sound.
User EQ	Allows the low, mid, and high-range frequency bands to be adjusted separately.

■ Changing the Tone Control type

After entering the Basic Settings menu (page 53):

The Tone Control setting will be selected automatically.

Press the ∇ or \wedge VALUE buttons to cycle through the different Tone Control types.

Press the EXIT button to exit the Tone Control setting and return to the main settings menu.

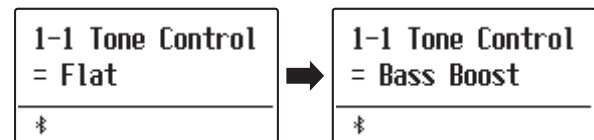

Brilliance

The Brilliance setting allows the overall brightness of the ES520 digital piano's sound to be adjusted, independently of the "Voicing" Virtual Technician setting.

■ Adjusting the Brilliance setting

After entering the Tone Control menu:

Press the ∇ or \wedge VALUE buttons to select the Brilliance setting mode.

Then press the MENU \wedge button, Brilliance setting screen will be shown in the display.

Press the ∇ or \wedge VALUE buttons to adjust the Brilliance setting.

* Brilliance can be adjusted within the range of -10~+10.

Press the EXIT button to exit the Brilliance setting and return to the main settings menu.

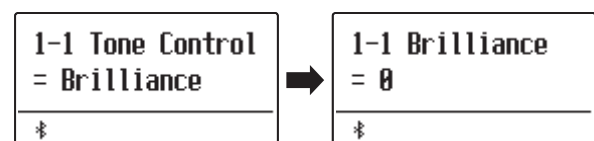

User EQ

The User EQ option allows finer control over the instrument's sound character, allowing the volume of four frequency bands to be adjusted individually. It is also possible to adjust the frequency range of the mid-low and mid-high frequency bands.

User EQ setting

User EQ	Description
Low	Adjusts the volume of the low range frequency band (20~100 Hz).
Mid-low Frequency	Adjusts the frequency of the mid-low band (200~8000 Hz).
Mid-high Frequency	Adjusts the frequency of the mid-high band (200~8000 Hz).
High	Adjusts the volume of the high range frequency band (5000~20000 Hz).

Adjusting the User EQ bands (low/mid/high)

After entering the Tone Control menu:

Press the ∇ or \wedge VALUE buttons to select the User EQ setting mode.

Then press the MENU \wedge button, User EQ setting screen will be shown in the display.

Press the ∇ or \wedge MENU buttons to cycle through the different User EQ settings, then press the ∇ or \wedge VALUE buttons to adjust the value of the selected setting.

* Frequencies set for Mid-low and Mid-high bands are applied to the second and third band equalisers from the left on the panel.

* The volume set in this function is applied to the middle position of the sliders of 4-band equalizer.

The volume settable for each band on this instrument is from -6dB to +6dB.

When the volume is set to +6dB in User EQ, +6dB is applied at the middle of the slider on the panel; therefore, the volume will not increase even if the slider is moved above the middle.

Press the EXIT button to exit the User EQ setting and return to the main settings menu.

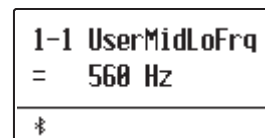
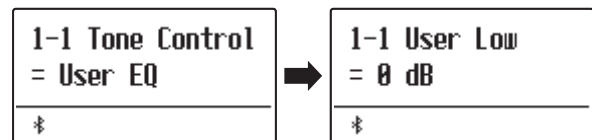

1-2 Tuning

The Tuning setting allows the overall pitch of the ES520 digital piano to be raised and lowered in 0.5 Hz steps, and may therefore prove useful when playing with other pitched instruments.

■ Adjusting the Tuning setting

After entering the Basic Settings menu (page 53):

Press the ∇ or \wedge MENU buttons to select the Tuning setting.

Press the ∇ or \wedge VALUE buttons to decrease or increase the value of the Tuning setting in 0.5 Hz steps.

* The Tuning setting can be adjusted within the range of 427.0 Hz~453.0 Hz.

Press the EXIT button to exit the Tuning setting and return to the main settings menu.

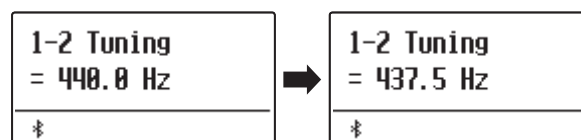

1-3 Damper Hold

The Damper Hold setting is used to determine whether sounds such as organ or strings should be sustained continuously when the sustain (damper) pedal is pressed, or whether these sounds should decay, naturally.

■ Damper Hold settings

Damper Hold	Description
Preset (default)	Organ sounds will be sustained continuously while the sustain pedal is pressed, but other String, etc. sounds will gradually decay, even while the sustain pedal is pressed.
On	Organ, string, etc. sounds will be sustained continuously while the sustain pedal is pressed.
Off	Organ, string, etc. sounds will gradually decay, even while the sustain pedal is pressed.

■ Changing the Damper Hold setting

After entering the Basic Settings menu (page 53):

Press the ∇ or \wedge MENU buttons to select the Damper Hold setting.

Press the ∇ or \wedge VALUE buttons to cycle through the different Damper Hold types.

Press the EXIT button to exit the Damper Hold setting and return to the main settings menu.

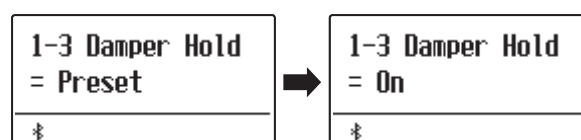

1-4 Four Hands

The Four Hands setting provides an alternative method to enabling the Four Hands Mode function, and may prove useful in teaching environments or situations where this function should be enabled automatically every time the ES520 digital piano is turned on.

* Please refer to page 22 for information about the Four Hands Mode function.

■ Four Hands settings

Four Hands	Description
Off (default)	Four Hands Mode will be turned off by default.
On	Four Hands Mode will be turned on by default.

■ Changing the Four Hands setting

After entering the Basic Settings menu (page 53):

Press the ∇ or \wedge MENU buttons to select the Four Hands setting.

Press the ∇ or \wedge VALUE buttons to turn the Four Hands setting on or off.

* When enabled, the LED indicators for the SPLIT and SOUND buttons will start to flash.

Press the EXIT button to exit the Four Hands setting and return to the main settings menu.

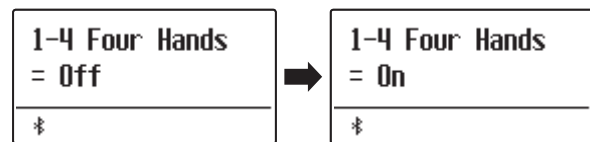

1-5 Startup Setting

The Startup Setting function allows preferred panel settings to be stored in the instrument's memory, and automatically recalled as the default settings every time the ES520 digital piano is turned on.

■ Settings stored in Startup Setting memory

General	Settings
Selected sound	Basic Settings
Dual Mode / Split Mode (sounds, volume balance, split point)	Virtual Technician
Reverb, Effects, Amp Simulator (type, settings)	Key Settings
Transpose (Key Transpose only)	MIDI Settings
Metronome (Beat, Tempo, Volume)	Phones Settings

* Auto Power Off setting and Bluetooth setting are stored to Startup Setting automatically.

■ Storing current settings to Startup Setting memory

After entering the Basic Settings menu (page 53):

Press the ∇ or \wedge MENU buttons to select the Startup Setting function.

Press the ● (REC) button.

A confirmation message will be shown in the display.

Press the VALUE \wedge button to confirm the store operation.
Press the EXIT button to cancel the store operation.

* After storing the Startup Setting, the instrument will exit the settings menu and return to normal playing mode.

Press the EXIT button to exit the Startup Setting function and return to the main settings menu.

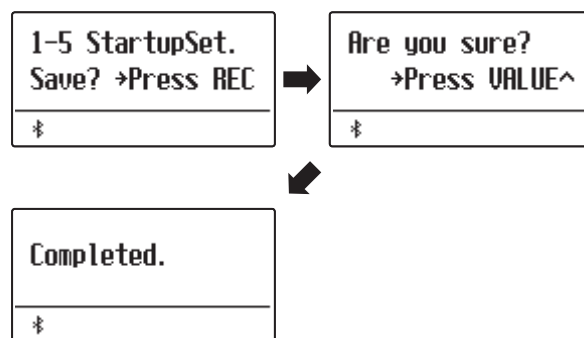

■ Recalling individual Startup Setting values

After selecting a setting:

Press the ∇ and \wedge VALUE buttons simultaneously.

The selected setting will be restored to the default (power on) value.

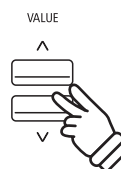

1-6 Factory Reset

The Factory Reset function clears any settings stored using the Startup Setting function above, restoring the ES520 digital piano back to its factory default settings.

* This function does not clear registration memories or recorder songs stored in internal memory.

■ Restoring factory settings

After entering the Basic Settings menu (page 53):

Press the \vee or \wedge MENU buttons to select the Factory Reset function.

Press the \bullet (REC) button.

A confirmation message will be shown in the display.

Press the VALUE \wedge button to confirm the reset operation.

Press the EXIT button to cancel the reset operation.

* After performing a factory reset, the instrument will exit the settings menu and return to normal playing mode.

Press the EXIT button to exit the Factory Reset function and return to the main settings menu.

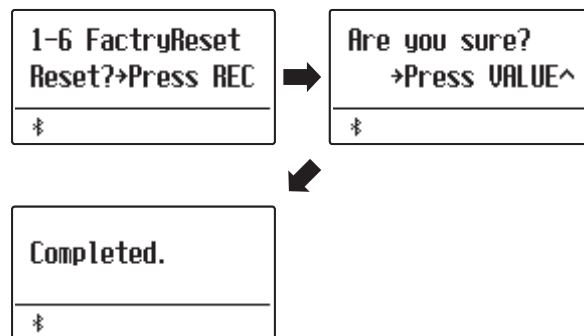

1-7 Auto Display Off

The Auto Display Off setting can be used to automatically turn off the display when the control panel is not being operated.

* To prevent the ES520 digital piano's display from "burn in" as a result of showing the same screen for an extended period of time, this setting is enabled by default.

■ Auto Display Off settings

Auto Display Off	Description
15 sec.	The display will turn off automatically after 15 seconds of inactivity.
5 min. (default)	The display will turn off automatically after 5 minutes of inactivity.
30 min.	The display will turn off automatically after 30 minutes of inactivity.

■ Changing the Auto Display Off setting

After entering the Basic Settings menu (page 53):

Press the ∇ or \wedge MENU buttons to select the Auto Display Off setting.

Press the ∇ or \wedge VALUE buttons to change the Auto Display Off setting.

Press the EXIT button to exit the Auto Power Off setting and return to the main settings menu.

* When the display turns off automatically, pressing any control panel button will turn it on again.

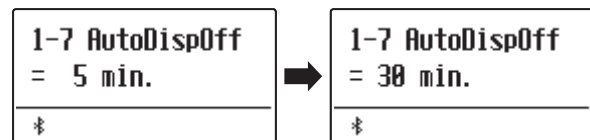

1-8 Auto Power Off

The Auto Power Off setting can be used to automatically turn off the instrument after a specified period of inactivity. This function may be enabled by default, depending on the market location.

■ Auto Power Off settings

Auto Power Off	Description
Off	The Auto Power Off function is disabled.
15 min.	The instrument will turn off automatically after 15 minutes of inactivity.
60 min.	The instrument will turn off automatically after 60 minutes of inactivity.
120 min.	The instrument will turn off automatically after 120 minutes of inactivity.

* The default Auto Power Off setting varies depending on market location.

■ Changing the Auto Power Off setting

After entering the Basic Settings menu (page 53):

Press the ∇ or \wedge MENU to select the Auto Power Off setting.

Press the ∇ or \wedge VALUE buttons to change the Auto Power Off setting.

Press the EXIT button to exit the Auto Power Off setting and return to the main settings menu.

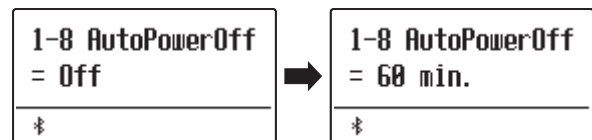

Virtual Technician

An experienced piano technician is essential to fully realise the potential of a fine acoustic piano. In addition to meticulously tuning each note, the technician also performs numerous regulation and voicing adjustments that allow the instrument to truly sing.

The Virtual Technician settings of the ES520 digital piano simulate these refinements digitally, allowing performers to shape various aspects of the instrument's character to suit their personal preferences.

* Any changes made by this operation will remain until the power is turned off.

Preferred settings can be stored in a Registration memory or Startup Setting. Please refer to page 37 and 58 for more information.

■ Virtual Technician

Page no.	Setting	Description	Default setting
2-1	Touch Curve	Adjust the touch sensitivity of the keyboard.	Normal
2-2	Voicing	Adjust the tonal character of the instrument.	Normal
	User Voicing	Adjust the individual voicing of each of the 88 keys.	0
2-3	Damper Resonance	Adjust the resonance that is heard when pressing the damper pedal.	5
2-4	Damper Noise	Adjust the volume of the sound that is heard when pressing the damper pedal.	5
2-5	String Resonance	Adjust the resonance that is heard when notes are held.	5
2-6	Key-off Effect	Adjust the volume of the sound that is heard when keys are released.	5
2-7	Fall-back Noise	Adjust the volume of the sound that is heard when the key action falls back.	5
2-8	Hammer Delay	Adjust the delay of the hammer striking strings when playing pianissimo.	Off
2-9	Topboard	Adjust the position of the grand piano topboard.	Open 3
2-10	Decay Time	Adjust the decay time of the piano sound while the keys are pressed.	5
2-11	Minimum Touch	Adjust the minimum key velocity required to produce a sound.	1
2-12	Temperament	Adjust the tuning system to suit Renaissance and Baroque periods etc.	Equal Temp.
	Stretch Tuning	Select how stretch tuning is applied to piano sounds and other sounds.	Piano Only
	Stretch Curve	Adjust the level of stretch tuning for equal temperaments.	Normal
	Temperament Key	Set the temperament key when not using equal temperament.	C
	User Temperament	Adjust the tuning of each note in the scale to a custom temperament.	0
2-13	User Key Volume	Adjust the individual volume of each of the 88 keys.	Normal
2-14	Half-Pedal Adjust	Adjust the point at which the damper pedal begins to sustain the sounds.	5
2-15	Soft Pedal Depth	Adjust the depth/effectiveness of the soft pedal.	3

■ Entering the Virtual Technician menu

While the normal playing mode screen is shown in the display:

Press the ∇ or \wedge MENU buttons to select the Virtual Technician menu.

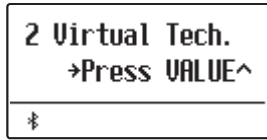

Press the VALUE \wedge button to enter the Virtual Technician menu.

The first page of the Virtual Technician menu will be shown in the display

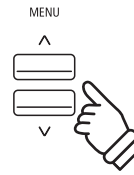

■ Selecting the desired setting

After entering the Virtual Technician menu:

Press the ∇ or \wedge MENU buttons to cycle through the different settings pages.

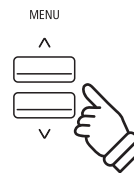
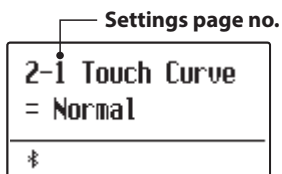

2-1 Touch Curve

As with an acoustic piano, the ES520 digital piano produces a louder sound when the keys are struck with force, and a softer sound when the keys are played gently. The volume and tonal character change in relation to the strength and speed of playing – on a digital piano this system is referred to as “touch sensitivity”.

The Touch Curve setting allows the touch sensitivity of the keyboard to be conveniently adjusted. There are four different preset touch curve settings available.

■ Touch Curve types

Touch Curve	Description
Heavy	Soft sound can be produced more evenly.
Normal (default)	Volume varies like acoustic pianos would responding to the touch.
Light	Suitable for young children and organ players.
Off	The same volume is sustained regardless of the strength of the touch.

■ Changing the Touch Curve type

After entering the Virtual Technician menu (page 63):

The Touch setting will be selected automatically.

Press the ∇ or \blacktriangle VALUE buttons to cycle through the different touch curve types.

Press the EXIT button to exit the Touch Curve setting and return to the main settings menu.

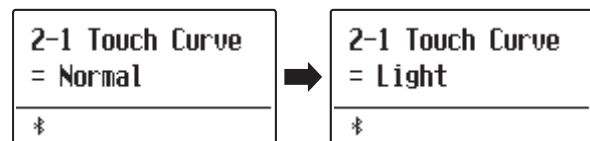

■ Jump to Touch Curve setting shortcut

It is also possible to access the Touch Curve setting directly while a piano sound is selected in Single Mode (i.e. not Dual Mode, Split Mode, or Four Hands Mode):

Press and hold the MENU ∇ or MENU \blacktriangle buttons. The Touch Curve setting will be shown in the display.

Press the ∇ or \blacktriangle VALUE buttons to change the Touch Curve setting.

To exit the Touch Curve setting and return to the previous screen, press the EXIT button twice.

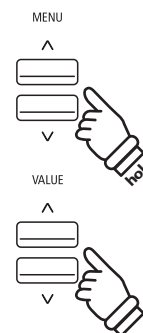

2-2 Voicing

On an acoustic piano, the shape, density, and texture of the hammers all influence the tonal character of the instrument's sound. Technicians utilise a variety of tools such as needles, files, and brushes to manipulate these hammer felts, with the ultimate goal of achieving a balanced tonal character across the keyboard.

The Voicing setting recreates various hammer properties, allowing the overall tonal character of the ES520 digital piano to be adjusted. There are six different preset voicing settings available (applied uniformly to all keys), with an additional "User" setting that allows players to perform custom adjustments on each individual key.

While the default "Normal" voicing setting should be appropriate for a broad range of musical genres, it may be desirable to select a softer, more mellow tonal character for romantic pieces, or a brighter, more aggressive tone for modern styles.

* This Virtual Technician setting will affect all sounds.

■ Voicing types

Voicing type	Description
Normal (default)	The normal tonal character of an acoustic piano throughout the entire dynamic range.
Mellow 1	A softer, more mellow tonal character throughout the entire dynamic range.
Mellow 2	An even softer tonal character than Mellow 1.
Dynamic	A tonal character that changes dramatically from mellow to bright, depending on the strength of key strike.
Bright 1	A bright tonal character throughout the entire dynamic range.
Bright 2	An even brighter tonal character than Bright 1.
User	A custom tonal character, allowing each key to be individually voiced.

■ Changing the Voicing type

After entering the Virtual Technician menu (page 63):

Press the ∇ or \wedge MENU buttons to select the Voicing setting.

Press the ∇ or \wedge VALUE buttons to cycle through the different voicing types.

Press the EXIT button to exit the Voicing setting and return to the main settings menu.

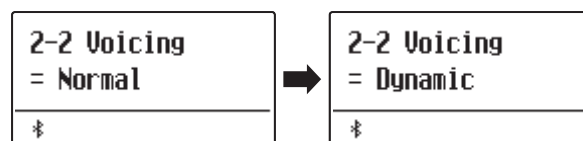

User Voicing

The User Voicing function allows each of the 88 keys to be voiced individually.

■ Selecting the note, adjusting the user voicing value

After selecting the Voicing setting (page 65):

Press the ∇ or \wedge VALUE buttons to select the User Voicing memory.

Press the ● (REC) button.

The User Voicing screen will be shown in the display.

Press the desired key to be tuned, then press the ∇ or \wedge VALUE buttons to set the desired voicing value.

The desired key can also be selected by pressing the ∇ or \wedge MENU buttons.

* The User Voicing value can be adjusted within the range of -5~+5, with lower values creating a mellower sound and higher values creating a brighter sound.

Press the STOP button to exit the User Voicing setting and return to the Voicing setting.

* User Voicing settings are automatically saved and the settings are still effective after restarting the instrument.

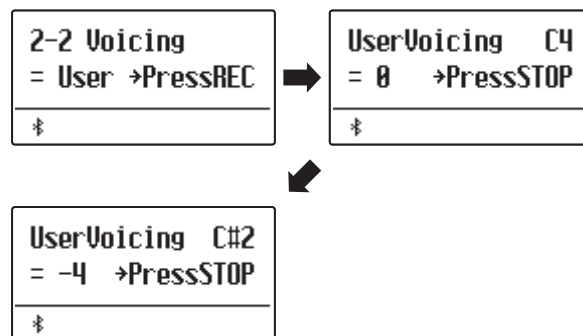

2-3 Damper Resonance

Pressing the damper pedal of an acoustic piano raises all dampers, allowing the strings to vibrate freely. When a note or chord is played on the piano with the sustain pedal pressed, not only will the strings of the notes played vibrate, but also the strings of other notes, vibrating in sympathetic resonance.

The ES520 digital piano recreates this phenomenon, with the Damper Resonance setting allowing the volume of this resonance sound to be adjusted.

* This Virtual Technician setting will affect acoustic piano sounds only.

■ Adjusting the Damper Resonance volume

After entering the Virtual Technician menu (page 63):

Press the ∇ or \wedge MENU buttons to select the Damper Resonance setting.

Press the ∇ or \wedge VALUE buttons to adjust the volume of the Damper Resonance setting.

* The Damper Resonance volume can be adjusted within the range of Off, 1~10, with higher values resulting in a more pronounced resonance.

Press the EXIT button to exit the Damper Resonance setting and return to the main settings menu.

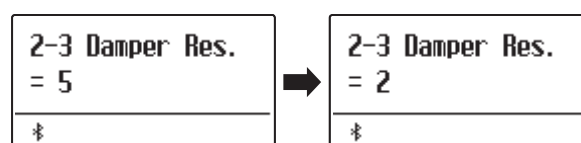

2-4 Damper Noise

When the damper pedal of an acoustic piano is pressed and released, it is often possible to hear the sound of the damper head touching and releasing the strings.

The ES520 digital piano reproduces this sound, with the Damper Noise setting allowing the volume of this sound to be adjusted. The speed at which the damper pedal is pressed will also influence the prominence of the damper noise, with fast pedalling creating a very pronounced sound.

* This Virtual Technician setting will affect acoustic piano sounds only.

■ Adjusting the Damper Noise volume

After entering the Virtual Technician menu (page 63):

Press the ∇ or \wedge MENU buttons to select the Damper Noise setting.

Press the ∇ or \wedge VALUE buttons to adjust the volume of the Damper Noise setting.

* The Damper Noise volume can be adjusted within the range of Off, 1~10, with higher values resulting in a more pronounced noise.

Press the EXIT button to exit the Damper Noise setting and return to the main settings menu.

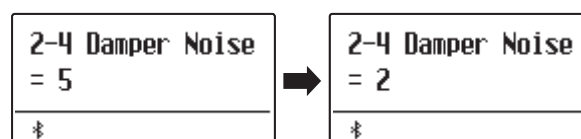

2-5 String Resonance

String Resonance refers to a phenomenon that exists in acoustic pianos whereby the strings of held notes resonate “sympathetically” with other notes of the same harmonic overtone series.

The ES520 digital piano recreates this phenomenon, with the String Resonance setting allowing the volume of this resonance to be adjusted.

* This Virtual Technician setting will affect acoustic piano sounds only.

■ Demonstrating String Resonance

To experience the string resonance phenomenon, gently hold down the “C” key as shown in the illustration below, then press any of the keys marked with a ● symbol. In addition to the sound of each note played, it should also be possible to hear the strings of the first “C” key resonating “sympathetically”, thus demonstrating String Resonance.

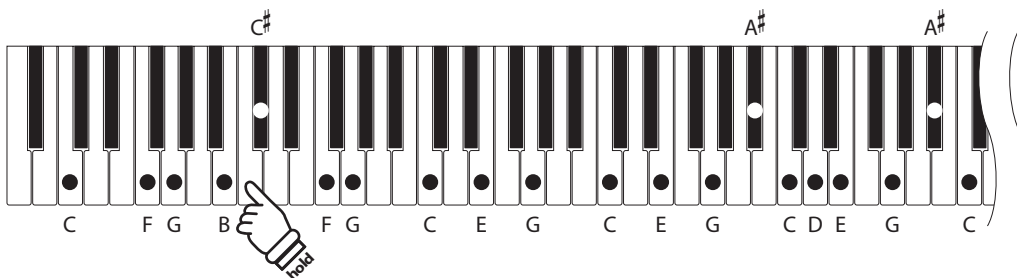

■ Adjusting the String Resonance volume

After entering the Virtual Technician menu (page 63):

Press the ∨ or ∧ MENU buttons to select the String Resonance setting.

Press the ∨ or ∧ VALUE buttons to adjust the volume of the String Resonance setting.

* The String Resonance volume can be adjusted within the range of Off, 1~10, with higher values resulting in a more pronounced resonance.

Press the EXIT button to exit the String Resonance setting and return to the main settings menu.

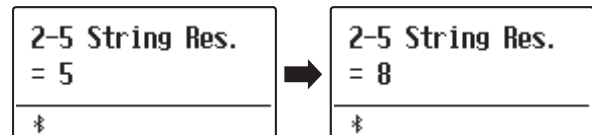

2-6 Key-off Effect

When playing an acoustic piano – particularly in the bass region of the keyboard – if a key is played with force and released quickly, it is often possible to hear the faint sound of the damper touching the strings immediately before the vibrations are stopped.

In addition, the speed at which keys are lifted will also affect the character of the sound. For example, when lifting the keys quickly (e.g. staccato playing) the “release” portion of the sound will be noticeably shorter than when lifting the keys slowly (e.g. legato playing).

The ES520 digital piano reproduces both characteristics, with the Key-off Effect setting allowing the volume of the key-off sound to be adjusted, and the key-off release speed detection to be turned on or off.

* This Virtual Technician setting will affect acoustic piano, Classic E.P., Classic E.P.2, 60's E.P., 60's E.P.2, and Harpsichord sounds.

■ Adjusting the Key-off Effect volume

After entering the Virtual Technician menu (page 63):

Press the ∇ or \wedge MENU buttons to select the Key-off Effect setting.

Press the ∇ or \wedge VALUE buttons to adjust the volume of the Key-off Effect setting.

* The Key-off Effect volume can be adjusted within the range of Off, 1~10, with higher values resulting in a more pronounced effect.

* When the Key-off Effect setting is set to Off, the key-off release speed detection will also be disabled, and the speed at which keys are lifted will not affect the character of the sound.

Press the EXIT button to exit the Key-off Effect setting and return to the main settings menu.

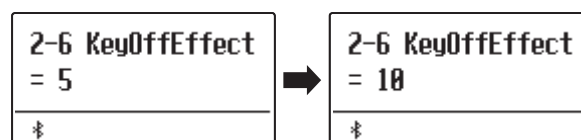

2-7 Fall-back Noise

When playing an acoustic piano, it is often possible to hear the faint sound of the keyboard action returning (i.e. “falling back”) to the neutral position after a key is released.

The ES520 digital piano reproduces this sound, with the Fall-back Noise setting allowing the volume of this sound to be adjusted.

While the default value is intended to simulate the natural volume level of the keys as they return to their neutral position, it may occasionally be desirable to adjust the volume of this sound. For example, reducing the volume when playing very soft pieces, where the fall-back noise may become too prominent.

* This Virtual Technician setting will affect acoustic piano sounds only.

■ Adjusting the Fall-back Noise volume

After entering the Virtual Technician menu (page 63):

Press the \vee or \wedge MENU buttons to select the Fall-back Noise setting.

Press the \vee or \wedge VALUE buttons to adjust the volume of the Fall-back Noise setting.

* The Fall-back Noise volume can be adjusted within the range of Off, 1~10, with higher values resulting in a more pronounced noise.

Press the EXIT button to exit the Fall-back Noise setting and return to the main settings menu.

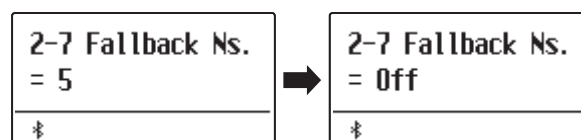

2-8 Hammer Delay

When playing pianissimo passages using an acoustic piano, there may be a perceived delay between a key being pressed and the hammer striking the strings.

If desired, the ES520 digital piano can recreate this delay, with the Hammer Delay setting allowing the delay length to be adjusted.

While the default value of "Off" is intended to replicate a well-regulated concert grand piano, with an immediate connection between the keyboard and hammers, some players may find it desirable to introduce a minor delay, in order to mimic different types of piano or instruments with a slightly worn keyboard action.

* This Virtual Technician setting will affect acoustic piano sounds only.

■ Adjusting the Hammer Delay value

After entering the Virtual Technician menu (page 63):

Press the \vee or \wedge MENU buttons to select the Hammer Delay setting.

Press the \vee or \wedge VALUE buttons to adjust the value of the Hammer Delay setting.

* The Hammer Delay value can be adjusted within the range of Off, 1~10, with higher values resulting in an increased delay.

Press the EXIT button to exit the Hammer Delay setting and return to the main settings menu.

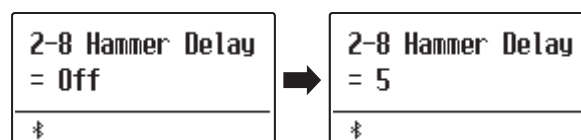

2-9 Topboard

When playing an acoustic grand piano, the position of the instrument's topboard (lid) affects both the volume and "openness" of the tone produced. A fully open topboard allows sound waves to reflect off the polished lid surface and project into the room, while a closed lid has the opposite effect, resulting in a darker, more opaque tone.

The ES520 digital piano attempts to simulate these characteristics, with four different topboard positions.

* This Virtual Technician setting will affect acoustic piano sounds only.

■ Topboard positions

Topboard position	Description
Open3 (default)	Simulates the character of a fully open topboard, with maximum sound projection.
Open2	Simulates the character of a half open topboard, with reduced sound projection.
Open1	Simulates the character of a partially open topboard, with limited sound projection.
Closed1	Simulates the character of a closed rear topboard, but open front topboard, with limited sound projection.
Closed2	Simulates the character of a closed rear topboard and closed front topboard, with minimum sound projection.

■ Changing the Topboard position

After entering the Virtual Technician menu (page 63):

Press the ∇ or \wedge MENU buttons to select the Topboard setting.

Press the ∇ or \wedge VALUE buttons to cycle through the different Topboard types.

Press the EXIT button to exit the Topboard setting and return to the main settings menu.

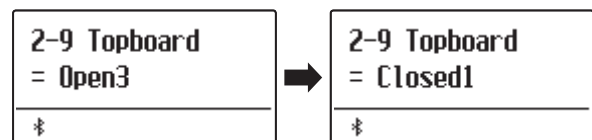

2-10 Decay Time

When playing an acoustic grand piano, the length of the instrument influences the speed at which held notes decay, with longer grand pianos (i.e. longer strings) characterised by longer decay times.

The ES520 digital piano attempts to simulate this characteristic, with the Decay Time setting allowing the length of decay while keys are pressed to be adjusted.

* This Virtual Technician setting will affect all sounds.

■ Adjusting the Decay Time volume

After entering the Virtual Technician menu (page 63):

Press the ∇ or \wedge MENU buttons to select the Decay Time setting.

Press the ∇ or \wedge VALUE buttons to adjust the volume of the Decay Time setting.

* The Decay Time volume can be adjusted within the range of 1~10, with larger values resulting in increased decay times.

* The Decay Time setting can be set independently for each sound.

Press the EXIT button to exit the Decay Time setting and return to the main settings menu.

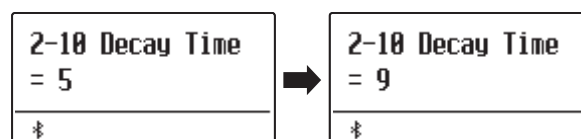

2-11 Minimum Touch

The Minimum Touch setting allows the minimum key velocity required to produce a sound to be adjusted. By default, this setting attempts to recreate the extremely fine touch sensitivity of a concert grand piano, allowing a very soft sound to be produced with the slightest of key touches. However, it may be desirable to reduce this sensitivity, when wishing to recreate the feeling of a small grand piano or an upright piano.

* This Virtual Technician setting will affect acoustic piano sounds and E.PIANO (excluding Modern E.P.)

■ Adjusting the Minimum Touch volume

After entering the Virtual Technician menu (page 63):

Press the ∇ or \wedge MENU buttons to select the Minimum Touch setting.

Press the ∇ or \wedge VALUE buttons to adjust the volume of the Minimum Touch setting.

* The Minimum Touch volume can be adjusted within the range of 1~20, with larger values requiring greater key force in order to produce a sound. For example, a value of 10 will require the keyboard to be played with a velocity of 10 or above in order to produce a sound.

Press the EXIT button to exit the Minimum Touch setting and return to the main settings menu.

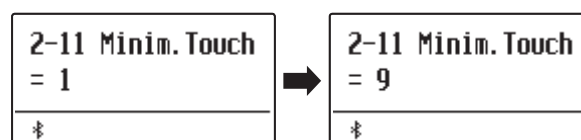

2-12 Temperament

The Temperament setting allows the tuning system used by the ES520 digital piano to be changed from the modern “Equal Temperament” standard to one of the various temperaments popularised during the Renaissance and Baroque periods. It is also possible to create customised temperaments using the User Temperaments function.

■ Temperament types

Temperament type	Description
Equal Temperament (default) (Equal)	This temperament is the most popular tuning method, and divides the scale into twelve equal semi-tones. This produces the same chordal intervals in all twelve keys, and has the advantage of limitless modulation of the key. However, the tonality of each key becomes less characteristic and no chord is in pure consonance.
Pure Temperament (Pure Major/Pure Minor)	This temperament, which eliminates dissonances for thirds and fifths, is still popular in choral music because of its perfect harmony. Any key modulation will result in dissonances. * The key of the temperament, and major/minor setting must be correctly matched.
Pythagorean Temperament (Pythagorean)	This temperament, which uses mathematical ratios to eliminate dissonance for fifths, is very limited for use with chords, but produces very characteristic melodic lines.
Meantone Temperament (Meantone)	This temperament, which uses a mean between a major and minor whole tone to eliminate dissonance for thirds, was devised to eliminate the lack of consonances experienced with certain fifths for the Mersenne pure temperament. It produces chords that are more beautiful than those played with equal temperament.
Werckmeister Temperament (Werckmeister) Kirnberger Temperament (Kirnberger)	These two temperaments are placed in between Meantone and Pythagorean. For music with few accidentals, this temperament produces the beautiful chords of the mean tone, but as accidentals increase, the temperament produces the characteristic melodies of the Pythagorean temperament. It is used primarily for classical music written in the Baroque era to revive the original characteristics.
User Temperament (User)	A custom temperament, created by raising or lowering the pitch of each note in the scale.

■ Changing the Temperament type

After entering the Virtual Technician menu (page 63):

Press the \checkmark or \wedge MENU buttons to select the Temperament setting.

Press the \checkmark or \wedge VALUE buttons to cycle through the different temperament types.

Press the EXIT button to exit the Temperament setting and return to the main settings menu.

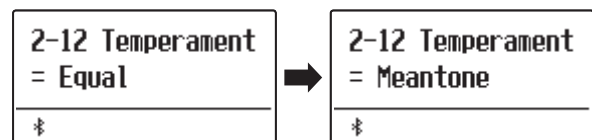

Stretch Tuning

The Stretch Tuning setting specifies whether stretch tuning should be applied for acoustic piano sounds only, all sounds, or disabled entirely.

Stretch tuning is a piano-specific tuning method used by acoustic piano technicians in which the lower octaves are tuned slightly flatter and the upper octaves are tuned slightly sharper to match the natural harmonics of an acoustic piano.

* This setting is only effective when Temperament is set to Equal Temperament.

■ Stretch Tuning setting

Stretch Tuning	Description
Piano Only (default)	Stretch tuning is applied to acoustic piano sounds only.
Off	Stretch tuning is disabled.
On	Stretch tuning is applied to all sounds.

■ Selecting the Stretch Tuning type

After selecting the Equal Temperament type (page 74):

Press the ∇ or \wedge MENU buttons to select the Stretch Tuning setting.

Press the ∇ or \wedge VALUE buttons to cycle through the Stretch Tuning setting.

Press the EXIT button to exit the Stretch Tuning setting and return to the main settings menu.

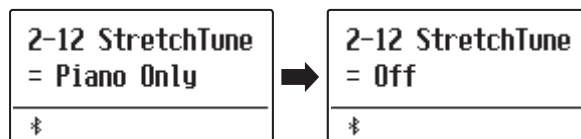

Stretch Curve

The Stretch Curve setting specifies the degree of stretch tuning to be applied to the sound. It is also possible to create custom tuning methods using one of the four User Tuning types.

* This setting is only effective when Stretch Tuning is set to On/Piano Only, and Temperament is set to Equal Temperament.

■ Stretch Curve setting

Stretch Curve	Description
Normal (default)	Normal stretch tuning.
Wide	Wide stretch tuning.
User 1~4	User defined tuning methods.

■ Selecting the Stretch Curve type

After entering the Virtual Technician menu (page 63):

Press the ∇ or \wedge MENU buttons to select the Stretch Curve setting.

Press the ∇ or \wedge VALUE buttons to cycle through the different Stretch Curve types.

Press the EXIT button to exit the Stretch Curve setting and return to the main settings menu.

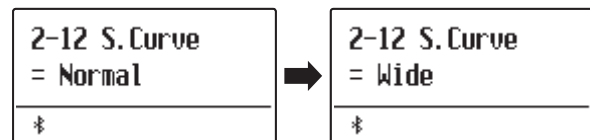

Temperament Key

The Temperament Key setting allows the key of the selected temperament to be specified. When using a temperament other than Equal temperament, use this setting to specify the key signature of the piece.

* This setting will only affect the “balance” of the tuning system, the pitch of the keyboard will remain unchanged.

■ Changing the Temperament Key setting

After selecting a temperament *other than* Equal temperament types:

Press the ∇ or \wedge MENU buttons to select Temperament Key setting.

Press the ∇ or \wedge VALUE buttons to select the desired temperament key.

* The temperament key can be set within the range of C to B.

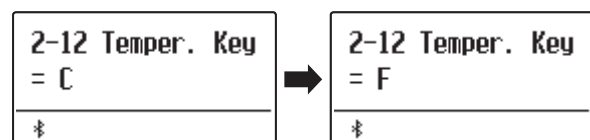

User Temperament

The User Temperament setting allows custom temperaments to be created.

* This setting is only available when User Temperament is selected.

Selecting the note, adjusting the user temperament value

After entering the Virtual Technician menu (page 63):

Press the MENU \wedge button.

Press the \vee or \wedge MENU buttons to select the desired note to be adjusted.

Press the \vee or \wedge VALUE to adjust the cent value for the selected note.

* The User Temperament value can be adjusted within the range of -50~+50.

Press the EXIT button to exit the User Temperament setting and return to the main settings menu.

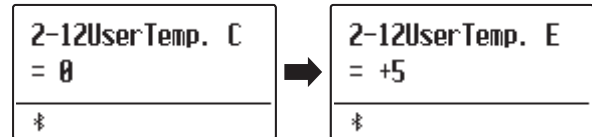

2-13 User Key Volume

The User Key Volume settings allows the volume of each of the 88-keys to be adjusted individually.

Selecting the note, adjusting the User Key Volume

After entering the Virtual Technician menu (page 63):

Press the \vee or \wedge MENU buttons to select the User Key Volume setting.

Press the \vee or \wedge VALUE buttons to select the User Key Volume memory.

Press the \bullet (REC) button to adjust the User Key Volume memory.

Press the desired key to be adjusted, then press the \vee or \wedge VALUE buttons to select the desired volume value.

The desired key can also be selected by pressing the \vee or \wedge MENU buttons.

Press the STOP button to exit the User Key Volume setting and return to the User Key Volume memories selection.

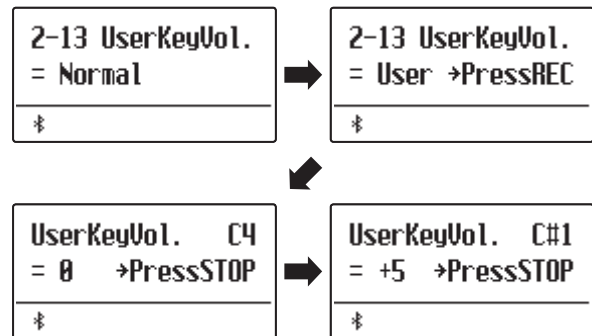

2-14 Half-Pedal Adjust

The Half-Pedal Adjust setting allows the point at which the damper/sustain pedal becomes effective (i.e. when the dampers of the piano begin to lift from the strings) to be adjusted. This setting may be useful for pianists that habitually rest their right foot on the damper/sustain pedal, but do not necessarily wish to sustain the sound.

* This Virtual Technician setting will affect all sounds.

■ Half-Pedal Adjust settings

Half-Pedal Adjust	Description
1	This setting allows the half-pedal to start at the earliest point.
⋮	⋮
7	This setting allows the half-pedal to start at the latest point.
8	This setting allows the damper pedal to be used as the controller. Control can be done when the pedal is pressed slightly.
⋮	⋮
10	This setting allows the damper pedal to be used as the controller. Control can be done in the widest range.

■ Adjusting the Half-Pedal Adjust volume

After entering the Virtual Technician menu (page 63):

Press the \checkmark or \wedge MENU buttons to select the Half-Pedal Adjust setting.

Press the \checkmark or \wedge VALUE buttons to adjust the volume of the Half-Pedal Adjust setting.

* The Half-Pedal Adjust volume can be adjusted within the range of 1~10.

Press the EXIT button to exit the Half-Pedal Adjust setting and return to the main settings menu.

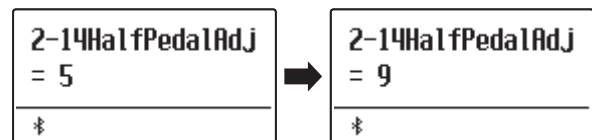

2-15 Soft Pedal Depth

The Soft Pedal Depth setting adjusts the effectiveness (i.e. depth/strength) of the soft pedal.

* This Virtual Technician setting will affect all sounds.

■ Adjusting the Soft Pedal Depth volume

After entering the Virtual Technician menu (page 63):

Press the \checkmark or \wedge MENU buttons to select the Soft Pedal Depth setting.

Press the \checkmark or \wedge VALUE buttons to adjust the volume of the Soft Pedal Depth setting.

* The Soft Pedal Depth volume can be adjusted within the range of 1~10, with higher values resulting in a softer sound.

Press the EXIT button to exit the Soft Pedal Depth setting and return to the main settings menu.

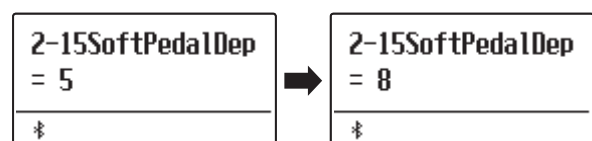

Key Settings

The Key Settings menu contains settings to adjust the instrument's operation when using the Dual or Split playing modes.

* Any changes made by this operation will remain until the power is turned off.

Preferred settings can be stored in a Registration memory or Startup Setting. Please refer to page 37 and 58 for more information.

■ Key Settings

Page no.	Setting	Description	Default setting
3-1	Lower Octave	Raise the pitch of the lower section in octave steps when using Split mode.	0
3-2	Lower Pedal	Enable/disable sustain pedal for the lower section when using Split mode.	Off
3-3	Split Balance	Adjust the volume balance between the upper and lower sections.	9 : 9
3-4	Layer Octave	Raise the pitch of the layered sound in octave steps when using Dual mode.	0
3-5	Layer Dynamics	Adjust the dynamic sensitivity of the layered sound when using Dual mode.	10
3-6	Dual Balance	Adjust the volume balance between the main and layered sounds.	9 : 9

■ Entering the Key Settings menu

While the normal playing mode screen is shown in the display:

Press the ∇ or \wedge MENU buttons to select the Key Settings menu.

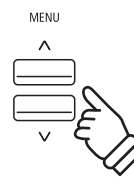
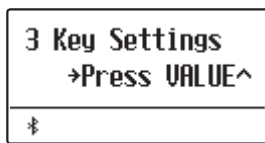

Press the VALUE \wedge button to enter the Key Settings menu.

The first page of the Key Settings menu will be shown in the display



■ Selecting the desired setting

After entering the Key Settings menu:

Press the ∇ or \wedge MENU buttons to cycle through the different settings pages.

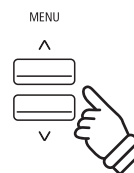
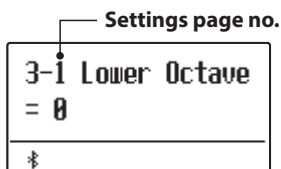

3-1 Lower Octave Shift

The Lower Octave Shift setting allows the pitch of the lower section when using Split mode to be raised in octave steps.

■ Changing the Lower Octave Shift value

After entering the Key Settings menu (page 79):

The Lower Octave Shift setting will be selected automatically.

Press the ∇ or \wedge VALUE buttons to decrease or increase the value of the Lower Octave Shift setting.

* The pitch of the lower section can be raised by up to 3 octaves.

Press the EXIT button to exit the Lower Octave Shift setting and return to the main settings menu.

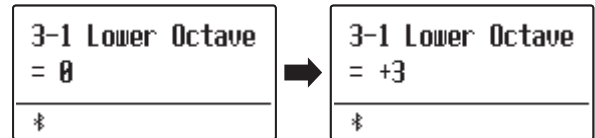

■ Jump to Lower Octave Shift setting shortcut

It is also possible to access the Lower Octave Shift setting directly while Split Mode or Four Hands Mode are in use.:

Press and hold the MENU ∇ or MENU \wedge buttons.

The Lower Octave Shift setting will be shown in the display.

Press the ∇ or \wedge VALUE buttons to adjust the Lower Octave Shift setting.

To exit the Lower Octave Shift setting and return to the previous screen, press the EXIT button twice.

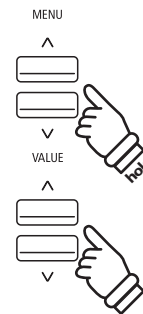

3-2 Lower Pedal

The Lower Pedal setting determines whether or not the sustain pedal will affect (i.e. sustain) the lower sound when using Split mode.

■ Lower Pedal settings

Lower Pedal	Description
Off (default)	In Split mode, lower section sounds will not be sustained when the sustain pedal is pressed.
On	In Split mode, lower section sounds will be sustained when the sustain pedal is pressed.

■ Changing the Lower Pedal setting

After entering the Key Settings menu (page 79):

Press the ∇ or \wedge MENU buttons to select the Lower Pedal setting.

Press the ∇ or \wedge VALUE buttons to turn the Lower Pedal setting on or off.

Press the EXIT button to exit the Lower Pedal setting and return to the main settings menu.

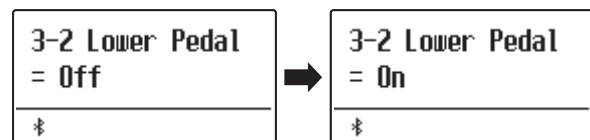

3-3 Split Balance

The Split Balance setting allows the volume balance between the upper and lower sections when using Split mode to be adjusted.

* The Split Balance setting can also be used adjusted directly while Split mode is in use. Please refer to page 21 for more information.

■ Adjusting the Split Balance setting

After entering the Key Settings menu (page 79):

Press the ∇ or \wedge MENU buttons to select the Split Balance setting.

Press the ∇ or \wedge VALUE buttons to adjust the volume balance between the upper and lower sections.

After increasing to the maximum volume (9) of one section, the volume of the other section will start to decrease.

Press the EXIT button to exit the Split Balance setting and return to the main settings menu.

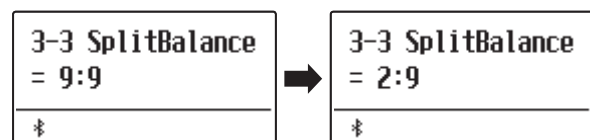

3-4 Layer Octave Shift

The Layer Octave Shift setting allows the pitch of the layered sound when using Dual mode to be raised or lowered in octave steps.

■ Changing the Layer Octave Shift value

After entering the Key Settings menu (page 79):

Press the ∇ or \wedge MENU buttons to select the Layer Octave Shift setting.

Press the ∇ or \wedge VALUE buttons to decrease or increase the value of the Layer Octave Shift setting.

* The pitch of the layered sound can be raised or lowered by up to 2 octaves.

* Some layered sounds may not produce a tone when the octave range is raised beyond a certain value.

Press the EXIT button to exit the Layer Octave Shift setting and return to the main settings menu.

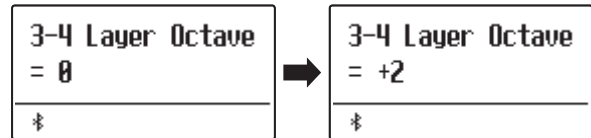

■ Jump to Layer Octave Shift setting shortcut

It is also possible to access the Layer Octave Shift setting directly while Dual Mode is in use.

Press and hold the MENU ∇ or MENU \wedge buttons.

The Layer Octave Shift setting will be shown in the display.

Press the ∇ or \wedge VALUE buttons to adjust the Layer Octave Shift setting.

To exit the Layer Octave Shift setting and return to the previous screen, press the EXIT button twice.

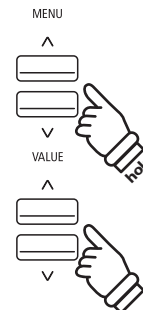

3-5 Layer Dynamics

When using Dual mode, sometimes simply adjusting the volume balance between the two layered sounds is not enough to create the desired sound character, especially if both sounds are very dynamic. Layering two equally dynamic sounds can prove difficult to control and play comfortably.

The Layer Dynamics Function allows the dynamic sensitivity of the layered sound to be reduced, in order to improve the blend between the two combined sounds. In addition to reducing the volume of the layered sound, limiting its dynamic sensitivity also allows the layered sound to be controlled more easily in relation to the main sound.

■ Adjusting the Layer Dynamics setting

After entering the Key Settings menu (page 79):

Press the ∇ or \wedge MENU buttons to select the Layer Dynamics setting.

Press the ∇ or \wedge VALUE buttons to decrease or increase the value of the Layer Dynamics setting.

* The layer dynamics value can be adjusted within the range of off, 1~10.

Press the EXIT button to exit the Layer Dynamics setting and return to the main settings menu.

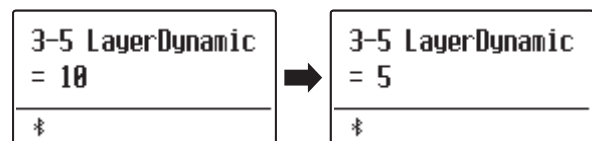

3-6 Dual Balance

The Dual Balance setting allows the volume balance between the main and layered sounds when using Dual mode to be adjusted.

* The Dual Balance setting can also be used adjusted directly while Dual mode is in use. Please refer to page 19 for more information.

■ Adjusting the Dual Balance setting

After entering the Key Settings menu (page 79):

Press the ∇ or \wedge MENU buttons to select the Dual Balance setting.

Press the ∇ or \wedge VALUE buttons to adjust the volume balance between the main and layered sections.

After increasing to the maximum volume (9) of one sound, the volume of the other sound will start to decrease.

Press the EXIT button to exit the Dual Balance setting and return to the main settings menu.

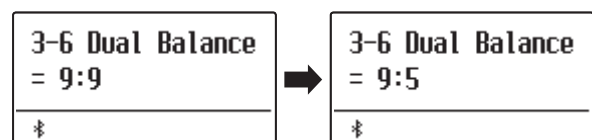

Phones Settings

The Phones Settings menu contains settings to select the SHS (Spatial Headphone Sound) mode, the type of headphones to be used, and the output volume of the connected headphones.

* Any changes made by this operation will remain until the power is turned off.

Preferred settings can be stored in a Registration memory or Startup Setting. Please refer to page 37 and 58 for more information.

■ Phones Settings

Page no.	Setting	Description	Default setting
4-1	SHS Mode	Select the desired SHS (Spatial Headphone Sound) mode.	Normal
4-2	Phones Type	Select the type of headphones to be used with the instrument.	Normal

■ Entering the Phones Settings menu

While the normal playing mode screen is shown in the display:

Press the ∇ or \wedge MENU buttons to select the Phones Settings menu.



Press the VALUE \wedge button to enter the Phones Settings menu.

The first page of the Phones Settings menu will be shown in the display

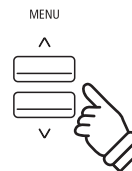

■ Selecting the desired setting

After entering the Phones Settings menu:

Press the ∇ or \wedge MENU buttons to cycle through the different settings pages.

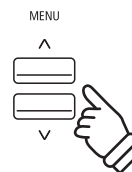
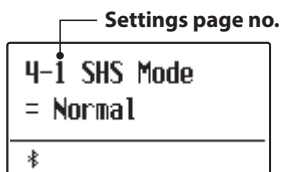

4-1 SHS Mode

Spatial Headphone Sound (SHS) is a special feature of the ES520 digital piano that enhances the depth and realism of the acoustic piano sound when listening through headphones or earphones.

The SHS Mode setting allows the player to select from one of three different acoustic presets that adjust the spatial positioning of the sound, while also helping to reduce auditory fatigue when using earphones or headphones for extended periods of time.

* This setting does not affect the speaker or Line Out sound.

■ SHS Mode setting

SHS Mode	Description
Off	Disable the Spatial Headphone Sound feature.
Forward	Front focused, somewhat narrow spatial positioning.
Normal (default)	Naturally balanced spatial positioning that is neither forward nor wide.
Wide	Wide, very open spatial positioning.

■ Changing the SHS Mode setting

After entering the Phones Settings menu (page 84):

Press the ∇ or \wedge MENU buttons to select the SHS Mode setting.

Press the ∇ or \wedge VALUE buttons to cycle through the different SHS Mode types types.

Press the EXIT button to exit the SHS Mode setting and return to the main settings menu.

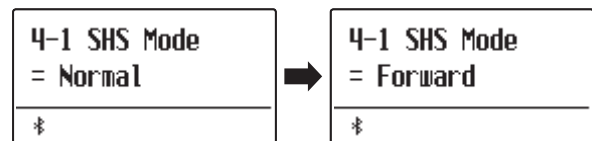

4-2 Phones Type

The Phones Type setting optimises the sound of the ES520 digital piano when listening through different types of headphones or earphones.

* This setting does not affect the speaker or Line Out sound.

■ Phones Type setting

Phones Type	Description
Normal (default)	Disables headphone optimisation.
Open	Optimises the sound for open type headphones.
Semi-open	Optimises the sound for semi-open type headphones.
Closed	Optimises the sound for closed type headphones.
Inner-ear	Optimises the sound for inner-ear type headphones.
Canal	Optimises the sound for canal-type headphones.

■ Changing the Phones Type setting

After entering the Phones Settings menu (page 84):

Press the ∇ or \wedge MENU buttons to select the Phones Type setting.

Press the ∇ or \wedge VALUE buttons to cycle through the different earphone/headphone types.

Press the EXIT button to exit the Phones Type setting and return to the main settings menu.

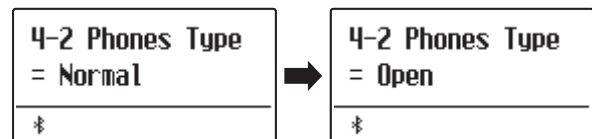

MIDI Settings

The MIDI Settings menu contains various functions and settings related to MIDI.

* For information regarding MIDI functions and settings, please download the supplementary PDF manual from the Kawai Global website: <https://www.kawai-global.com/support/manual>

Bluetooth Settings

The Bluetooth Settings menu contains settings to enable/disable Bluetooth MIDI and Bluetooth Audio, and adjust the volume of the Bluetooth Audio input.

* Availability of Bluetooth MIDI function dependent on market location.

■ Bluetooth Settings

Page no.	Setting	Description	Default setting
6-1	Bluetooth Audio	Enable/disable the instrument's Bluetooth Audio function.	Off
6-2	Bluetooth Audio Volume	Adjust the volume of Bluetooth Audio input.	0
6-3	Bluetooth MIDI	Enable/disable the instrument's Bluetooth MIDI function.	On

■ Entering the Bluetooth Settings menu

While the normal playing mode screen is shown in the display:

Press the ∇ or \blacktriangle MENU buttons to select the Bluetooth Settings menu.



Press the VALUE \blacktriangle button to enter the Bluetooth Settings menu.

The first page of the Bluetooth Settings menu will be shown in the display

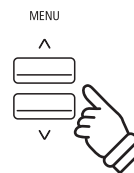

■ Selecting the desired setting

After entering the Bluetooth Settings menu:

Press the ∇ or \blacktriangle MENU buttons to cycle through the different settings pages.

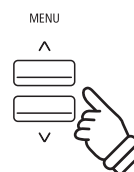
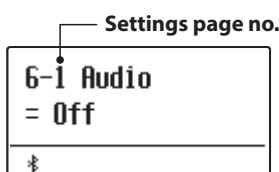

6-1 Bluetooth Audio

The Bluetooth Audio setting is used to enable/disable the ES520 digital piano's Bluetooth Audio function. When enabled, the ES520 digital piano can be connected to smart phones, tablets, and other smart devices to facilitate wireless audio communication, allowing music stored on a device to be played through the instrument's speaker system/headphones.

* This setting will be stored automatically, and recalled every time the instrument is turned on.

■ Bluetooth Audio setting

Bluetooth Audio	Description
Off (default)	The instrument's Bluetooth Audio function will be turned off.
On	The instrument's Bluetooth Audio function will be turned on.

■ Changing the Bluetooth Audio setting

After entering the Bluetooth Settings menu (page 87):

Press the ∇ or \wedge MENU buttons to select the Bluetooth Audio setting.

Press the ∇ or \wedge VALUE to turn the Bluetooth Audio setting on or off.

Press the EXIT button to exit the Bluetooth Audio setting and return to the main settings menu.



■ Connecting the ES520 digital piano to a smart device using Bluetooth Audio

After enabling the Bluetooth Audio function of the ES520 digital piano, enable Bluetooth communications on the smart device. After a few seconds "ES520 Audio" should appear in the smart device's Bluetooth settings device list. Tap the "ES520 Audio" entry to connect the instrument to the smart device. It should now be possible for audio produced by the smart device to be heard through the instrument's speaker system/headphones.

- * If loss of audio/connectivity or noise occurs, please check for Bluetooth Audio compatibility with the smart device manufacturer.
- * For a list of potential issues and recommended solutions when using Bluetooth communications, please refer to page 95 of this owner's manual.
- * The Auto Power Off setting will still be observed when playing audio via Bluetooth Audio.

6-2 Bluetooth Audio Volume

The Bluetooth Audio Volume setting is used to increase or decrease the volume level of Bluetooth Audio playback. While it's generally preferable to adjust the audio volume level on the smart device itself, this setting may still be useful in certain situations.

* This setting will be stored automatically, and recalled every time the instrument is turned on.

■ Adjusting the volume setting of the Bluetooth Audio Volume

After entering the Bluetooth Settings menu (page 87):

Press the ∇ or \wedge MENU buttons to select the Bluetooth Audio Volume setting.

Press the ∇ or \wedge VALUE to increase or decrease the level of the Bluetooth Audio Volume setting.

* The Bluetooth Audio Volume setting can be adjusted within the range of -16~+15.

* To reset the Bluetooth Audio Volume setting to the default value, press

Press the EXIT button to exit the Bluetooth Audio Volume setting and return to the main settings menu.

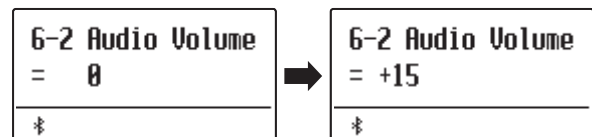

6-3 Bluetooth MIDI

The Bluetooth MIDI setting is used to enable/disable the ES520 digital piano's Bluetooth MIDI function. When enabled, the ES520 digital piano can be connected to smart phones, tablets, and other smart devices to facilitate wireless MIDI communication, allowing a wide range of music-related apps to be enjoyed using the instrument.

* This setting will be stored automatically, and recalled every time the instrument is turned on.

■ Bluetooth MIDI setting

Bluetooth MIDI	Description
Off	The instrument's Bluetooth MIDI function will be turned off.
On (default)	The instrument's Bluetooth MIDI function will be turned on.

■ Changing the Bluetooth MIDI setting

After entering the Bluetooth Settings menu (page 87):

Press the ∇ or \wedge MENU buttons to select the Bluetooth MIDI setting.

Press the ∇ or \wedge VALUE to turn the Bluetooth MIDI setting on or off.

Press the EXIT button to exit the Bluetooth MIDI setting and return to the main settings menu.

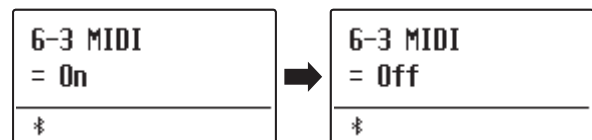

■ Connecting the ES520 digital piano to a smart device using Bluetooth MIDI

After enabling the Bluetooth MIDI function of the ES520 digital piano, enable Bluetooth communications on the smart device, then open the desired MIDI app. After a few seconds "ES520" should appear in the app's device list. Tap the "ES520" entry to connect the instrument to the smart device. It should now be possible for MIDI apps to communicate wirelessly with the ES520 digital piano.

- * When the ES520 digital piano is connected to a smart device via Bluetooth MIDI, the USB MIDI and MIDI IN/OUT connectors will be disabled.
- * Please check for Bluetooth MIDI compatibility with the smart device manufacturer and app developer.
- * For a list of potential issues and recommended solutions when using Bluetooth communications, please refer to page 95 of this owner's manual.
- * For more detailed instructions regarding Bluetooth pairing, please refer to the supplementary Bluetooth® Connectivity Guide manual, available from the Kawai Global website: <http://www.kawai-global.com/support/manual>

Connecting to Other Devices

The rear side of the ES520 digital piano features a variety of jacks that allow the instrument be connected to MIDI devices, computers, speakers, and mixers. It is also possible to connect external audio sources, such as an MP3 player, tablet, or a secondary keyboard, to the ES520's amplifier and speaker system. The illustration below provides a visual overview of the instrument's connectors and typical applications.

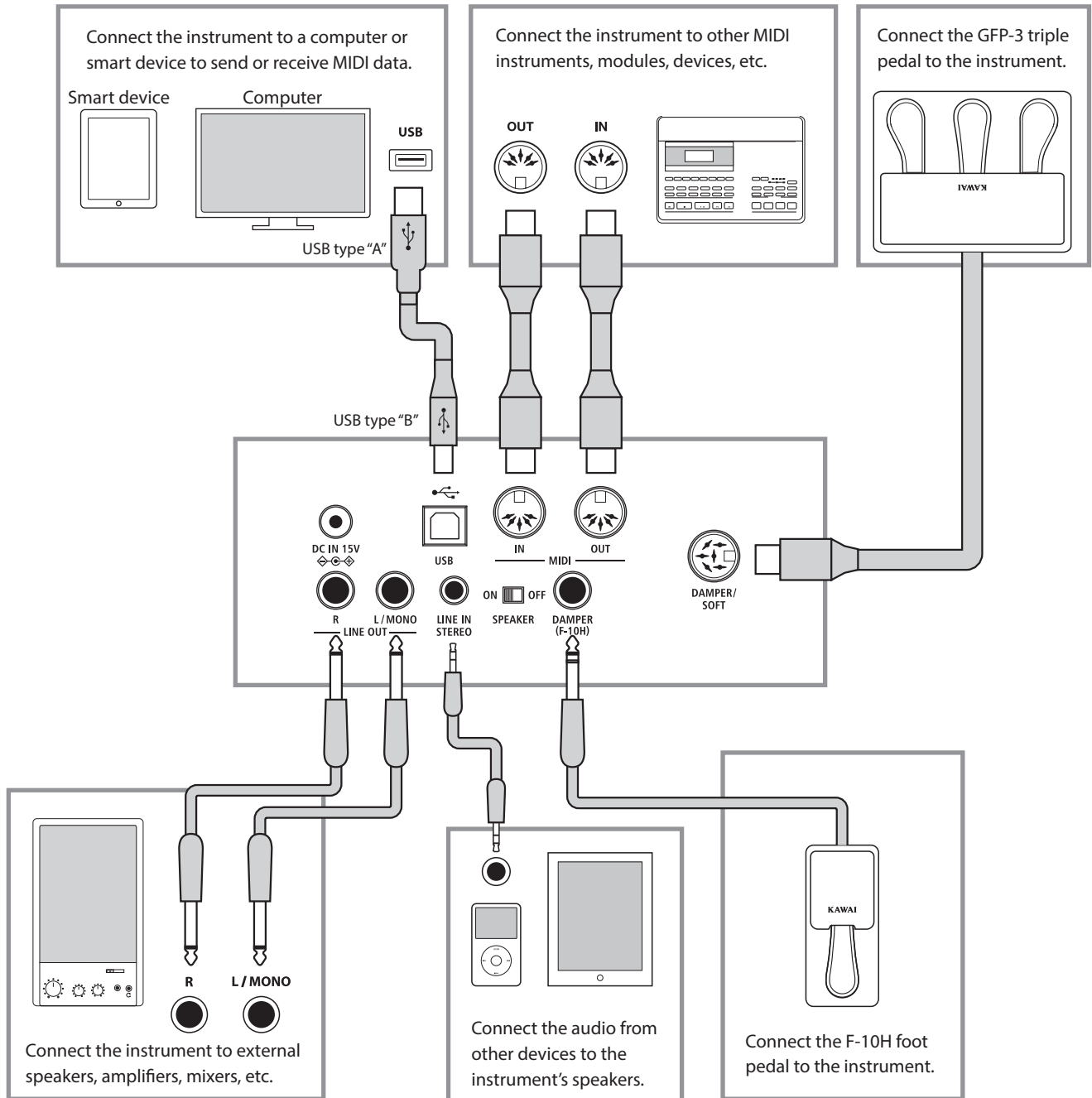

Before connecting the ES520 digital piano to other devices, ensure that the power to both the instrument and the other device is turned off. If connections are established while the power is turned on, extraneous noise that can damage the ES520 digital piano may activate the instrument's amplifier protection circuit, preventing any sound from being produced. If this occurs, turn the power off and then on again to reset the amplifier protection circuit.

Do not connect the LINE IN STEREO and LINE OUT jacks of the ES520 digital piano together with the same cable. An audio loop (oscillation sound) will occur, resulting in damage to the unit.

Rear Connectors

■ LINE OUT jacks (1/4" phone jack)

These jacks are used to connect the stereo output of the instrument's sound to external speakers, amplifiers, mixers, recording devices, and similar equipment. Mono signals will be output only if a cable is connected to the L/MONO jack.

■ LINE IN STEREO jacks (1/8" mini jack)

This jack is used to connect the stereo output from an external audio device, such as a CD or MP3 player, to the instrument's amplifier (incl. LINE OUT) and speaker system. To adjust the LINE IN level, please use the volume controls on the device itself.

■ MIDI IN/OUT jacks

These jacks are used to connect the ES520 digital piano to external MIDI devices, and also to a computer with a MIDI interface as an alternative to the "USB to Host" port.

* Please refer to page 87 for more information about MIDI.

■ SPEAKER ON/OFF switch

This switch is used to turn the ES520's built-in speakers on or off, and may be useful when connecting the instrument to external speakers or an amplification system via the LINE OUT jacks. Please note that when headphones are connected, sound will not be produced by the built-in speakers, regardless of the SPEAKER switch position.

■ DAMPER & DAMPER/SOFT jacks

These jacks are used to connect either the F-10H foot pedal, GFP-3 or F-302 triple pedal unit to the instrument.

* Please refer to page 14 for more information about pedal functions.

■ USB to Host port ("B" type)

This USB port is used to connect the ES520 digital piano to a computer using an inexpensive USB cable. When connected, the instrument can be used as a standard MIDI device, allowing it to send and receive MIDI data. Connect a "B" type USB connector to the instrument, and an "A" type USB connector to the computer. With additional conversion adaptors, this port may also be used to connect the ES520 digital piano to tablets such as the Apple iPad and other mobile devices.

* Please refer to page 93 for more information about USB MIDI.

Upper Connectors

■ USB to Device port ("A" type)

This USB port is used to connect a USB memory device to the ES520 digital piano. This allows SMF song files to be played directly. It is also possible to save recorder songs stored in internal memory for posterity.

* Only connect USB memory devices to the USB to Device port.

* Connect the USB memory device directly, without using a USB extension cable.

■ USB device information

■ The "USB to Device" functionality of the ES520 digital piano conforms to USB2.0 Hi-Speed standards. Older USB devices can still be used, however data transfer speed will be limited to the maximum transfer speed of the device.

Front Connectors

■ PHONES jacks (1/4" & 1/8" phone jacks)

These jacks are used to connect stereo headphones to the ES520 digital piano. Two pairs of headphones can be connected and used simultaneously. When a pair of headphones is connected, sound will not be produced by the speakers.

■ Avoid removing the USB memory device while data is being loaded or saved, files are being renamed or deleted, or the device is being formatted.

■ Other USB devices, such as computer mice, keyboards, or battery chargers etc. cannot be used with this instrument.

USB MIDI (USB to Host Connector)

The ES520 digital piano features a “USB to Host” type connector, allowing the instrument to be connected to a computer using an inexpensive USB cable and utilised as a MIDI device. Depending on the type of computer and operating system installed, additional driver software may be required for USB MIDI communication to function correctly.

For more information regarding the USB MIDI driver, please visit the following website:

<https://www.kawai-global.com/support/downloads/>

■ USB MIDI information

- Ensure that the instrument is turned OFF before attempting to connect the USB MIDI cable.
- When connecting the instrument to a computer using the USB MIDI port, there may be a short delay before communications begin.
- If the instrument is connected to a computer via a USB hub and USB MIDI communication becomes unreliable/unstable, please connect the USB MIDI cable directly to the one of the computer’s USB ports.
- Disconnecting the USB MIDI cable suddenly, or turning the instrument on/off while using USB MIDI may cause computer instability in the following situations:
 - while installing the USB MIDI driver
 - while starting up the computer
 - while MIDI applications are performing tasks
 - while the computer is in energy saver mode
- If there are any further problems experienced with USB MIDI communication while the instrument is connected, please double-check all connections and relevant MIDI settings in the computer’s operating system.

■ Intellectual property rights

- “Windows” is a registered trademark of Microsoft Corporation.
- “Mac” is a registered trademark of Apple Computer, Inc.
- Some samples © PREMIER Engineering Inc.
- The Bluetooth® word mark and logos are registered trademarks owned by the Bluetooth SIG, Inc. and any use of such marks by Kawai Musical Instruments Mfg. Co., Ltd. is under license.
- Qualcomm aptX is a product of Qualcomm Technologies, Inc. and/or its subsidiaries. Qualcomm is a trademark of Qualcomm Incorporated, registered in the United States and other countries. aptX is a trademark of Qualcomm Technologies International, Ltd., registered in the United States and other countries.



- Other company names and product names mentioned or referenced herein are registered trademarks or trademarks of respective owners.
- Kawai Musical Instruments Mfg. Co., Ltd. shall have no liability for any acts in violation of the Copyright Act made by any users of this product.

Information about Bluetooth®

Please refer to the following information about Bluetooth.

■ About Bluetooth

- The Bluetooth® word mark and logos are registered trademarks owned by the Bluetooth SIG, Inc. and any use of such marks by Kawai Musical Instruments Mfg. Co., Ltd. is under license.
- Frequency Band of Radio: 2400~2483.5 MHz Maximum Transmit Power: 2.5 mW (Bluetooth Low Energy), 4.5mW (A2DP)
- Availability of Bluetooth function dependent on market location.

■ For USA, Canada

It is strictly forbidden to use antenna except designated.
This equipment must not be co-located or operated in conjunction with any other antenna or transmitter.

■ For Canada

- This device complies with Industry Canada's licence-exempt RSSs. Operation is subject to the following two conditions:
(1) This device may not cause interference; and
(2) This device must accept any interference, including interference that may cause undesired operation of the device.
- Le présent appareil est conforme aux CNR d'Industrie Canada applicables aux appareils radio exempts de licence. L'exploitation est autorisée aux deux conditions suivantes :
(1) l'appareil ne doit pas produire de brouillage;
(2) l'utilisateur de l'appareil doit accepter tout brouillage radioélectrique subi, même si le brouillage est susceptible d'en compromettre le fonctionnement.

■ For South Africa



■ For Argentina

Marca : KAWAI, Bluegiga
Modelo : MBH7BLZ07, WT32i



■ For Korea

- 해당 무선설비는 전파혼신 가능성이 있으므로 인명안전과 관련된 서비스는 할 수 없습니다
- B 급 기기 (가정용 방송통신기자재) 이 기기는 가정용 (B 급) 전자파적합기기로서 주로 가정에서 사용하는 것을 목적으로 하며, 모든 지역에서 사용할 수 있습니다.
- 모델명 MBH7BLZ07 WT32i-A
- 인증을 받은 상표 이름제조사 Kawai Musical Instruments Manufacturing Co., Ltd. Bluegiga Technologies Oy
- 원산지 일본 핀란드
- 기자재 명칭 정소출력 무선기기 (무선데이터통신시스템용 무선기기)
- 제조년 월 제품에 붙어있는 라벨을 확인하시기 바랍니다.

■ For Mexico

PIANO DIGITAL

MARCA : KAWAI

MODELO : MBH7BLZ07, RCPKAMB16-1764
: WT32i, RCPKAWT17-1556



La operación de este equipo está sujeta a las siguientes dos condiciones:

- (1) es posible que este equipo o dispositivo no cause interferencia perjudicial
- (2) este equipo o dispositivo debe aceptar cualquier interferencia,

■ For Brazil

Este equipamento opera em caráter secundário, isto é, não tem direito a proteção contra interferência prejudicial, mesmo de estações do mesmo tipo e não pode causar interferência a sistemas operando em caráter primário. Para consultas, visite: www.anatel.gov.br



04349-16-10021

02414-18-01395

■ For Taiwan

第十二條 經型式認證合格之低功率射頻電機，非經許可，公司、商號或使用者均不得擅自變更頻率、加大功率或變更原設計之特性及功能。

第十四條 低功率射頻電機之使用不得影響飛航安全及干擾合法通信；經發現有干擾現象時，應立即停用，並改善至無干擾時方得繼續使用。前項合法通信，指依電信法規定作業之無線電通信。低功率射頻電機須忍受合法通信或工業、科學及醫療用電波輻射性電機設備之干擾。

Troubleshooting

The table below summarises issues that may be experienced with the ES520 digital piano, explaining the typical cause(s), and recommended solution(s).

	Issue	Possible Cause and Solution	Page no.
Power	The instrument does not turn on.	Check that the AC power adaptor is firmly attached to the instrument, and connected to an AC outlet.	p. 15
	The instrument turns itself off after a period of inactivity.	Check that the "Auto Power Off" setting is not enabled.	p. 61
Sound	The instrument is turned on, however no sound is produced when the keys are pressed.	Check that the MASTER VOLUME slider is not set to the lowest position.	p. 15
		Check that a pair of headphones (or headphone adaptor plug) are not connected to the PHONES jacks.	p. 14
		Check that the SPEAKER ON/OFF switch (rear connectors) is not set to Off.	p. 92
		Check that the Local Control setting in the MIDI Settings menu is set to On.	p. 87
	The sound distorts when playing at very loud volume levels.	Check that the MASTER VOLUME slider is set to an appropriate level, reducing the volume if excessive distortion is heard.	p. 15
Sound	Strange sounds or noises are heard when playing with piano sounds.	The ES520 digital piano attempts to reproduce the rich variety of tones created by an acoustic grand piano as accurately as possible. This includes string resonances and damper noises, and other subtle characteristics that contribute to the overall piano playing experience.	–
		While these additional tones are intended to enhance the realism of the instrument, it is possible to reduce their prominence, or disable the effects altogether using the settings in the Virtual Technician menu.	p. 62
	The top 18 notes of the keyboard sustain far longer than neighbouring notes, even when the damper pedal is not pressed.	This is the correct behaviour, and intended to reproduce the undamped notes (typically the top two octaves) of an acoustic grand piano.	–
Phones	The headphone volume is too low.	Check the technical specifications of the headphones.	–
USB	A USB memory device is not detected, cannot be saved to, or does not appear to function when connected to the "USB to Device" port.	Check that the USB memory device is formatted to use the FAT/FAT32 filesystem, and not set to "Write Protect" mode.	p. 92
		Disconnect the USB device, turn the instrument off then on, then reconnect the USB device. If the USB device still does not function, it may be damaged or incompatible. Please try using a different USB device.	–
	The instrument pauses briefly when connecting a USB memory device.	This is recognised behaviour when using very large capacity USB memory devices.	p. 92
SMF	An SMF MIDI file stored on a USB memory device sounds strange when played back.	The ES520 digital piano does not contain the full General MIDI sound bank selection. Consequently, some SMF song files may not be reproduced entirely accurately when played through the instrument.	p. 44

Demo Song List

Sound Name	Song Title	Composer
PIANO1		
SK ConcertGrand	Polonaise Brillante Op.22	Chopin
EX ConcertGrand	Polonaise-Fantaisie	Chopin
Jazz Clean	Original	Kawai
Warm Grand	Sonata No.30 Op.109	Beethoven
PIANO2		
Upright Piano	Alpenglühén Op.193	Oesten
Pop Grand	Original	Kawai
Modern Piano	Original	Kawai
Rock Piano	Original	Kawai
E.PIANO		
Classic E.Piano (*)	Original	Kawai
Classic E.P. 2	–	–
60's E.Piano	–	–
60's E.Piano 2	–	–
Modern E.Piano	Original	Kawai
ORGAN		
Jazz Organ (*)	Original	Kawai
Drawbar Organ (*)	Original	Kawai
Ballad Organ	–	–
Principal Oct.	–	–
Church Organ	Chorale Prelude "Wachet auf, ruft uns die Stimme"	J. S. Bach
HARPSI/MALLETS		
Harpsichord (*)	French Suite No. 6	J. S. Bach
Vibraphone	Original	Kawai
Clavi	Original	Kawai
Marimba	–	–
STRINGS/CHOIR		
String Ensemble	Le quattro stagioni: La primavera	A. Vivaldi
Slow Strings	Original	Kawai
String Pad	Original	Kawai
Warm Strings	–	–
Choir	Londonderry Air	Irish folk song
Square Pad	–	–
New Age Pad	Original	Kawai
BASS		
Electric Bass	Original	Kawai
Electric Bass 2 (*)	–	–
Electric Bass 3 (*)	–	–
Wood Bass	Original	Kawai
W. Bass & Ride	Original	Kawai

(*) PREMIER Sound

Copyright©PREMIER Engineering Inc.2018
PREMIER SOUND FACTORY

** Kawai regret that sheet music for Kawai original demo songs is not available.

EU Declaration of Conformity

BG	ОПРОСТЕНА ЕС ДЕКЛАРАЦИЯ ЗА СЪОТВЕТСТВИЕ
Bulgarian	C настоящото Kawai Европа GmbH декларира, че този тип радиосъоръжение [ES520] е в съответствие с Директива 2014/53/ЕС. Цялостният текст на ЕС декларацията за съответствие може да се намери на следния интернет адрес:
ES	DECLARACIÓN UE DE CONFORMIDAD SIMPLIFICADA
Spanish	Por la presente, Kawai Europa GmbH declara que el tipo de equipo radioeléctrico [ES520] es conforme con la Directiva 2014/53/UE. El texto completo de la declaración UE de conformidad está disponible en la dirección Internet siguiente:
CS	ZJEDNODUŠENÉ EU PROHLÁŠENÍ O SHODĚ
Czech	Tímto Kawai Europa GmbH prohlašuje, že typ rádiového zařízení [ES520] je v souladu se směrnicí 2014/53/EU. Úplné znění EU prohlášení o shodě je k dispozici na této internetové adrese:
DA	FORENKLET EU-OVERENSSTEMMELSESERKLÆRING
Danish	Hermed erklærer Kawai Europa GmbH, at radioudstyrstypen [ES520] er i overensstemmelse med direktiv 2014/53/EU. EU-overensstemmelseserklæringens fulde tekst kan findes på følgende internetadresse:
DE	VEREINFACHTE EU-KONFORMITÄTSERKLÄRUNG
German	Hiermit erklärt Kawai Europa GmbH, dass der Funkanlagentyp [ES520] der Richtlinie 2014/53/EU entspricht. Der vollständige Text der EU-Konformitätserklärung ist unter der folgenden Internetadresse verfügbar:
ET	LIHTSUSTATUD ELI VASTAVUSDEKLARATSIOON
Estonian	Käesolevaga deklareerib Kawai Europa GmbH, et käesolev raadioseadme tüüp [ES520] vastab direktiivi 2014/53/EL nõuetele. ELi vastavusdeklaratsiooni täielik tekst on kättesaadav järgmisel internetiaadressil:
EL	ΑΠΛΟΥΣΤΕΥΜΕΝΗ ΔΗΛΩΣΗ ΣΥΜΜΟΡΦΩΣΗΣ ΕΕ
Greek	Με την παρούσα ο/η Kawai Europa GmbH, δηλώνει ότι ο ραδιοεξοπλισμός [ES520] πληροί την οδηγία 2014/53/ΕΕ. Το πλήρες κείμενο της δήλωσης συμμόρφωσης ΕΕ διατίθεται στην ακόλουθη ιστοσελίδα στο διαδίκτυο:
EN	SIMPLIFIED EU DECLARATION OF CONFORMITY
English	Hereby, Kawai Europa GmbH declares that the radio equipment type [ES520] is in compliance with Directive 2014/53/EU. The full text of the EU declaration of conformity is available at the following internet address:
FR	DECLARATION UE DE CONFORMITE SIMPLIFIEE
French	Le soussigné, Kawai Europa GmbH, déclare que l'équipement radioélectrique du type [ES520] est conforme à la directive 2014/53/UE. Le texte complet de la déclaration UE de conformité est disponible à l'adresse internet suivante:
HR	POJEDNOSTAVLJENA EU IZJAVA O SUKLADNOSTI
Croatian	Kawai Europa GmbH ovime izjavljuje da je radijska oprema tipa [ES520] u skladu s Direktivom 2014/53/EU. Cjeloviti tekst EU izjave o sukladnosti dostupan je na sljedećoj internetskoj adresi:
IT	DICHIARAZIONE DI CONFORMITÀ UE SEMPLIFICATA
Italian	Il fabbricante, Kawai Europa GmbH, dichiara che il tipo di apparecchiatura radio [ES520] è conforme alla direttiva 2014/53/UE. Il testo completo della dichiarazione di conformità UE è disponibile al seguente indirizzo Internet:
LV	VIENKĀRŠOTA ES ATBILSTĪBAS DEKLARĀCIJA
Latvian	Ar šo Kawai Europa GmbH deklarē, ka radioiekārta [ES520] atbilst Direktīvai 2014/53/ES. Pilns ES atbilstības deklarācijas teksts ir pieejams šādā interneta vietnē:
LT	SUPAPRASTINTA ES ATITIKTIES DEKLARACIJA
Lithuanian	Aš, Kawai Europa GmbH, patvirtinu, kad radijo įrenginių tipas [ES520] atitinka Direktyvą 2014/53/ES. Visas ES atitikties deklaracijos tekstas prieinamas šiuo interneto adresu:
HU	EGYSZERŰSÍTETT EU-MEGFELELŐSÉGI NYILATKOZAT
Hungarian	Kawai Europa GmbH igazolja, hogy a [ES520] típusú rádióberendezés megfelel a 2014/53/EU irányelvnek. Az EU-megfelelőségi nyilatkozat teljes szövege elérhető a következő internetes címen:
MT	DIKJARAZZJONI SSMPLIFIKATA TA' KONFORMITÀ TAL-UE
Maltese	B'dan, Kawai Europa GmbH, niddikjara li dan it-tip ta' tagħmir tar-radju [ES520] huwa konformi mad-Direttiva 2014/53/UE. It-test kollu tad-dikjarazzjoni ta' konformità tal-UE huwa disponibbli f'dan l-indirizz tal-Internet li ġej:
NL	VEREENVOUDIGDE EU-CONFORMITEITSVERKLARING
Dutch	Hierbij verklaar ik, Kawai Europa GmbH, dat het type radioapparatuur [ES520] conform is met Richtlijn 2014/53/EU. De volledige tekst van de EU-conformiteitsverklaring kan worden geraadpleegd op het volgende internetadres:
PL	UPROSZCZONA DEKLARACJA ZGODNOŚCI UE
Polish	Kawai Europa GmbH niniejszym oświadcza, że typ urządzenia radiowego [ES520] jest zgodny z dyrektywą 2014/53/UE. Pełny tekst deklaracji zgodności UE jest dostępny pod następującym adresem internetowym:
PT	DECLARAÇÃO UE DE CONFORMIDADE SIMPLIFICADA
Portuguese	O(a) abaixo assinado(a) Kawai Europa GmbH declara que o presente tipo de equipamento de rádio [ES520] está em conformidade com a Diretiva 2014/53/UE. O texto integral da declaração de conformidade está disponível no seguinte endereço de Internet:
RO	DECLARAȚIA UE DE CONFORMITATE SIMPLIFICATĂ
Romanian	Prin prezenta, Kawai Europa GmbH declară că tipul de echipament radio [ES520] este în conformitate cu Directiva 2014/53/UE. Textul integral al declarației UE de conformitate este disponibil la următoarea adresă internet:
SK	ZJEDNODUŠENÉ EÚ VYHLÁSENIE O ZHODE
Slovak	Kawai Europa GmbH týmto vyhlasuje, že rádiové zariadenie typu [ES520] je v súlade so smernicou 2014/53/EÚ. Úplné EÚ vyhlásenie o zhode je k dispozícii na tejto internetovej adrese:
SL	POENOSTAVLJENA IZJAVA EU O SKLADNOSTI
Slovenian	Kawai Europa GmbH potrjuje, da je tip radijske opreme [ES520] skladen z Direktivo 2014/53/EU. Celotno besedilo izjave EU o skladnosti je na voljo na naslednjem spletnem naslovu:
FI	YKSINKERTAISTETTU EU-VAATIMUSTENMUKAISUUSVAKUUTUS
Finnish	Kawai Europa GmbH vakuuttaa, että radiolaitetyyppi [ES520] on direktiivin 2014/53/EU mukainen. EU-vaatimustenmukaisuusvakuutuksen täysimittainen teksti on saatavilla seuraavassa internetosoitteessa:
SV	FÖRENKLAD EU-FÖRSÄKRAN OM ÖVERENSSTÄMMELSE
Swedish	Härmed försäkras Kawai Europa GmbH att denna typ av radioutrustning [ES520] överensstämmer med direktiv 2014/53/EU. Den fullständiga texten till EU-försäkran om överensstämmelse finns på följande webbadress:
https://www.kawai-global.com/	

Kawai ES520 Specifications

Keyboard	Responsive Hammer Compact II (RHC II) action 88 weighted keys	
Sound Source	Progressive Harmonic Imaging™ (PHI), 88-key piano sampling	
Internal Sounds	34 voices	PIANO: 8 sounds, E.PIANO: 5 sounds, ORGAN: 5 sounds HARPSI/MALLETS: 4 sounds, STRINGS/CHOIR: 7 sounds, BASS: 5 sounds,
Polyphony	max. 192 notes	
Keyboard Modes	Dual Mode, Split Mode, Four Hands Mode (Volume/Balance adjustable)	
Reverb	Type:	Room, Lounge, Small Hall, Concert Hall, Live Hall, Cathedral
	Parameters:	Reverb Depth, Reverb Time
Effects	Type:	Mono Delay, Ping Delay, Triple Delay, Chorus, Classic Chorus, Ensemble, Tremolo, Classic Tremolo, Vibrato Tremolo, Auto Pan, Classic Auto Pan, Phaser, Classic Phaser, Compressor, Rotary 1, Rotary2
	Parameters:	Dry/Wet, Time, Speed, Feedback, HighDamp, Depth. Parameters dependent on effect type.
Amp Simulator	Type:	S.Case I, S.Case II, L.Cabinet
	Parameters:	Drive, Level, EQ Low, EQ High
Virtual Technician	Touch Curve, Voicing, Damper Resonance, Damper Noise, String Resonance, Key-off Effect, Fall-back Noise, Hammer Delay, Topboard, Decay Time, Minimum Touch, Stretch Tuning/Stretch Curve, Temperament, Temperament Key, User Key Volume, Half-Pedal Adjust, Soft Pedal Depth	
Internal Recorder	3 song, 1 track recorder – approximately 5,000 note memory capacity	
USB Functions	Playback:	SMF
	Other:	Save Internal Song, Load Registration, Save Registration, Rename File, Delete File
Metronome	1/4, 2/4, 3/4, 4/4, 5/4, 3/8, 6/8 (Volume/Tempo adjustable)	
Rhythm	Styles:	100 rhythms
Demo Songs	23 sound demo songs	
Registrations	28 memories (7 x 4)	
Other Functions	Transpose, Tone Control (incl. Brilliance, UserEQ), Tuning, Damper Hold, Four Hands, Startup Setting, Factory Reset, Auto Power Off, Lower Octave Shift, Lower Pedal On/Off, Split Balance, Layer Octave Shift, Layer Dynamics, Dual Balance, SHS Mode, Phones Type, MIDI Channel, Send PGM#, Local Control, Transmit PGM#, Multi-timbral Mode, Channel Mute, Auto Power Off, Speakers On/Off	
Display	128 x 64 pixel OLED	
Pedal	F-10H damper pedal (with half-pedal support)	
Bluetooth*	Bluetooth (Ver. 4.1; GATT compatible) Bluetooth Low Energy MIDI Specification compliant, Bluetooth Audio	
Connectors	LINE IN (1/8" STEREO), LINE OUT (1/4" L/MONO, R [unbalanced]), Headphones x 2 (1/4", 1/8"), MIDI (IN/OUT), USB to Host, USB to Device, DAMPER (for F-10H), DAMPER/SOFT/SOSTENUTO (for GFP-3/F-302)	
Speaker System	Speakers:	(8 x 12 cm) x 2
	Output Power:	20 W x 2
Power Consumption	18 W (PS-154 AC adaptor)	
Dimensions	1340 (W) x 375 (D) x 145 (H) mm / 52 3/4" (W) x 14 3/4" (D) x 5 3/4" (H)	
Weight	14.5 kg / 32 lbs.	

Specifications are subject to change without notice.

* Availability of Bluetooth function dependent on market location.

Owner's Manual Conventions

This owner's manual utilises a number of illustrative conventions in order to explain the ES520's various functions. The examples below provide an overview of the button LED indicator states and press types, and the appearance of different kinds of text.

■ Button LED indicator states



LED indicator off:
Sound/Function is not selected.



LED indicator on:
Sound/Function is selected.

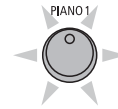

LED indicator flashing:
Sound/Function is selected in a temporary state.

■ Button press types



Normal press:
Select a sound or function.



Press twice:
Select a sound or function.



Press multiple times:
Cycle through sounds or settings.

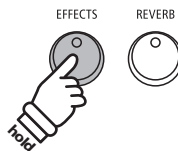

Press and hold:
Select a function's settings.

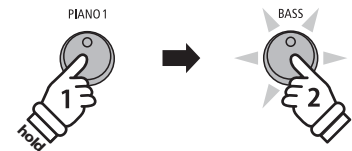

Press and hold, then press X:
Combine two sounds, or store registration memories etc.

■ Text appearance

Normal instruction and explanation text is written in regular type at 9 pt. size.

* Notes about functions are marked with an asterisk and written in 8 pt. size.

Reminders about previous operations are written in italic type at 9 pt. size.

• **Captions explaining the display or button functions, are written in bold type at 8.5 pt. size.**

Example operations are written in italic type at 8 pt. size, and enclosed within a grey box.

KAWAI

THE FUTURE OF THE PIANO

