

KAWAI

DIGITAL PIANO CA901/CA701 Owner's Manual

Important Information

Preparation

Basic Operation

Adjustments & Settings

Appendix

EN

Important Safety Instructions



Be sure to read these Safety Precautions carefully before using this instrument to ensure correct use.



When using this electronic musical instrument, please observe the following precautions for safety. When this instrument is used by small children, please ensure safe use under the supervision of a parent.

Warnings, cautions, and symbols have the following meanings









CAUTION:
TO REDUCE THE RISK OF ELECTRIC SHOCK, DO NOT DISASSEMBLE THE MAIN UNIT OF THIS INSTRUMENT. NO USER-SERVICEABLE PARTS INSIDE. REFER SERVICING TO QUALIFIED SERVICE PERSONNEL.



| |
|---|
|  <h3>WARNING</h3> <p>Describes a potential hazard that could result in death or serious injury if the indication is ignored and this instrument is handled incorrectly.</p> |
|  <h3>CAUTION</h3> <p>Describes a potential hazard that could result in injury or damage to property if the indication is ignored and this instrument is handled incorrectly.</p> |

| | |
|---|--|
|  | denotes that care (precaution) should be taken. |
|  | denotes a prohibited operation (an operation that must not be done). |
|  | denotes an instruction (an operation that should be carried out) or indicative notice. |

WARNING

Doing so may cause a electric shock, fire, injury fall, damage, or breakdown.

-  The product should be connected to an AC outlet of the specified voltage.
-  The included power cable is only for use with this instrument.
-  Do not forcibly bend, place a heavy object on, bring a high temperature object close to, or damage the power cable.
-  If dust accumulates on the power plug, wipe it clean with a cloth.
-  Do not disassemble, repair, or modify this instrument.
-  Do not insert or pull out the power plug with wet hands.
-  Do not get this instrument wet.

-  When disconnecting the power cable plug, always hold the plug and pull out.
 -  Disconnect the power cable during lightning storms or when this instrument is unused for long periods of time.
 -  Should an abnormality occur in this instrument, immediately turn the power off and disconnect the power plug from the outlet.
- When any of the following cases occur, this instrument may have broken down. In such a case, do not use this instrument, keep the power cable disconnected from the outlet, and contact the shop from which the product was purchased.
1. Foreign objects fell into the instrument.
 2. Water was spilled into the instrument.
 3. Some parts of the instrument or accessory became abnormally hot.
 4. Unusual smell or smoke occurred.



CAUTION

Doing so may cause a fall, damage, breakdown, injury, Health damage.



Keep the power cable plug in a state where it can be disconnected from the outlet easily.



This instrument is not completely shut-off from the power supply even when the power switch is turned off.
To shut-off completely, disconnect the power plug from the outlet.



When using the headphones, do not listen for long periods of time at high volume levels.



Do not run around this instrument.



Do not drop this instrument or apply a large impact.

Do not use this instrument in the following areas.

1. Areas where the floor is unstable and the instrument becomes wobbly.
2. Areas that become wet.
3. Extremely hot or cold areas.
4. Extremely humid or dry areas.
5. Areas where the instrument is exposed to direct sunlight, such as those near a window.
6. Areas where a large amount of sand or dust is present.
7. Areas where the instrument is exposed to excessive vibrations.



Do not use anything other than the company's optional stand.



Do not press your fingernails, sharp objects, or hard objects strongly against the surface of the display.



Do not stand on, hang down from, or push this instrument.



Read the assembly instructions in advance before assembling this instrument and bench (if included).



Regularly inspect the screws used to assemble this instrument and bench (if included) for looseness, and retighten if necessary.



The height adjustment of the bench (if included) should be performed when no one is sitting on it.



Keep small parts out of the reach of children.



When moving this instrument, always lift in a horizontal direction by two or more people.



Piano should be placed in a location such that its position does not affect its own ventilation.
Keep a minimum distance of 5 cm around the instrument for sufficient ventilation.



Do not put any part of your body under the keyboard cover, music stand, or pedals.



Do not put any part of your body under the music stand or pedals.

Nameplate location

The information, including model name and serial number, is specified on the nameplate located on the underside of the instrument.

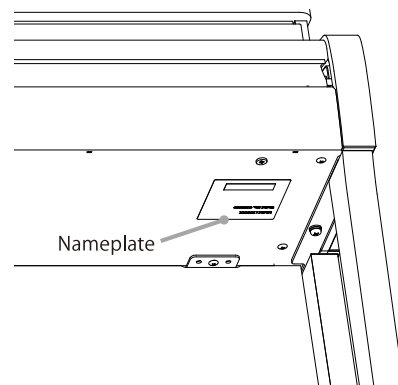

Règles de sécurité (Supplémentaires pour le Canada)

Exemples de symboles graphiques



AVERTISSEMENT

Indique un risque potentiel qui peut entraîner la mort, ou de graves lésions, si l'appareil n'est pas manipulé correctement.



PRECAUTION

Indique un risque potentiel qui peut entraîner la détérioration, ou des dommages, pour l'appareil ou ses propriétés, si celui-ci n'est pas manipulé correctement.



Indique que des précautions doivent être prises.



Indique une manipulation interdite.



Indique qu'une manipulation doit être effectuée.



AVERTISSEMENT

Cela constitue un risque de choc électrique, d'incendie, de blessures, de chute, de dégâts ou de panne.



Faite attention de ne pas introduire un produit étranger à l'intérieur de l'appareil.



Ne jamais placer sur le produit des objets contenant des liquides, tels que des vases ou autres récipients.



Ce produit n'est pas totalement déconnecté du circuit électrique lorsqu'il est mis hors tension par le bouton d'arrêt. Si l'appareil ne doit pas être utilisé pendant une longue période, débranchez le câble d'alimentation de la prise secteur.



Il est recommandé de placer l'instrument à proximité de la prise de courant et de positionner le câble d'alimentation secteur de sorte qu'il puisse être débranché rapidement en cas d'urgence, le courant électrique étant toujours présent tant que la prise est branchée même si le bouton de mise en marche est en position Arrêt.



ATTENTION

Cela constitue un risque de chute, de dégâts, de panne, de blessures, d'effet nocif sur la santé.



Description de la l'emplacement de la référence (Le cas échéant):

Anglais phrase: The nameplate label is located on the underside of the instruments, as indicated below.

Français phrase: La référence commerciale est inscrite sur une étiquette en dessous de votre instrument, conformément à l'indication ci-dessous.



Votre piano doit être placé à un endroit tel que sa position n'altère pas sa propre ventilation. Gardez une distance minimum de 5 cm autour de l'instrument pour une aération suffisante.

Notes on Repair

Should an abnormality occur in the product, immediately turn the power OFF, disconnect the power cable plug, and then contact the shop from which the product was purchased.

Information on disposal for users



If your product is marked with this recycling symbol it means that, at the end of its life, you must dispose of it separately by taking it to an appropriate collection point. You should not mix it with general household waste. Disposing of this product correctly will prevent potential negative effects on the environment and human health which could otherwise arise due to inappropriate waste handling.

For further details, please contact your local authority. (European Union only)

FCC Information (U.S.A)

Caution :

Changes or modifications not expressly approved by KAWAI could void the user's authority to operate the equipment.

Note :

This equipment has been tested and found to comply with the limits for a Class B digital device, pursuant to Part 15 of the FCC Rules. These limits are designed to provide reasonable protection against harmful interference in a residential installation. This equipment generates, uses and can radiate radio frequency energy and, if not installed and used in accordance with the instructions, may cause harmful interference to radio communications. However, there is no guarantee that interference will not occur in a particular installation. If this equipment does cause harmful interference to radio or television reception, which can be determined by turning the equipment off and on, the user is encouraged to try to correct the interference by one or more of the following measures:

- Reorient or relocate the receiving antenna.
- Increase the separation between the equipment and receiver. Connect the equipment into an outlet on a circuit different from that to which the receiver is connected.
- Consult the dealer or an experienced radio/TV technician for help.

Introduction

Thank you for purchasing this digital piano. In order to fully enjoy this instrument and use it for a long time, please carefully read this owner's manual and store it together with the warranty in a safe place for future reference.

About this owner's manual

- The owner's manual provides basic operation guides necessary to use this instrument immediately, as well as explanations of operations for mastering various functions.
- The display illustrations and functions shown in this manual may differ from those on the actual instrument depending on the version.

About intellectual property rights

- The **Bluetooth**® word mark and logos are registered trademarks owned by the Bluetooth SIG, Inc. and any use of such marks by Kawai Musical Instruments Mfg. Co., Ltd. is under license.
- Windows is a registered trademark of Microsoft Corporation.
- Mac is a registered trademark of Apple Inc.
- All other company and product names described in this manual are trademarks or registered trademarks of their respective owners.
- Use of existing copyrighted material such as commercially available CDs, music files, and standard MIDI files (SMF) with this instrument, whether for personal or private use within the home, is subject to copyright law and may not exceed the scope of acceptable use without the permission of the copyright holder. Kawai Musical Instruments Mfg. Co., Ltd. assumes no responsibility for any uses or acts that violate copyright law.

About notation



Information enclosed in brackets [] in descriptions of operations indicates the name of the slider, button, or terminal.



Indicates a note for the operation.



Indicates explanations of terms, and explanations when names and displays differ.



Indicates reference pages.

About cleaning

- Disconnect the power cable plug before cleaning.
- Refrain from using chemicals such as alcohol, benzene, thinner, or chlorine bleach, as they may cause discoloration or deterioration of parts such as the keyboard, exterior, or panels.
- Please note that repeated rubbing may cause discoloration or deterioration depending on the material of the cloth used.
- If the surface of the pedals becomes dirty, wipe them clean with a dry dishwashing sponge. If they are gold pedals, wiping them with a cloth may make them appear cloudy.
- If the pedals become dirty, do not use rust-removing polish or files.

M E M O

Table of Contents

Important Information

| | |
|-------------------------------------|---|
| Important Safety Instructions | 2 |
| Introduction | 6 |
| Table of Contents | 8 |

Preparation

| | |
|-------------------------------------|----|
| Part Names and Functions | 10 |
| Opening/Closing the Key Cover | 12 |
| Music Rest | 13 |
| Pedals | 14 |
| Power | 15 |
| Volume and Headphones | 16 |
| Home screen | 18 |

Basic Operation

| | |
|---|-----------|
| Piano Tab | 20 |
| Piano Selection area List | 21 |
| Sound Tab | 22 |
| Category Selection area List | 23 |
| Music tab | 26 |
| Category selection List | 27 |
| Playing a song/piece | 28 |
| Changing the Sound and Playing a Song | 29 |
| Metronome | 30 |
| Turning the Metronome on/off | 30 |
| Settings screen operation | 31 |
| Recorder | 32 |
| Mini Recorder screen | 32 |
| Recording a song | 33 |

Adjustments & Settings

| | |
|--|-----------|
| Editor | 35 |
| Accessing the Editor screen | 35 |
| Piano Variation | 36 |
| Main Sound | 38 |
| Sub Sound | 39 |
| VPA | 43 |
| Ambience | 45 |
| Reverb | 47 |
| Effect | 49 |
| Tuning | 52 |
| Transpose | 52 |
| Sound Management | 53 |
| VPA Detailed Settings | 57 |
| VPA Detailed Settings List | 57 |
| Accessing the VPA Detailed Settings Screen | 60 |
| Other Sound Settings (Sound tab only) | 71 |
| Player Detailed Functions | 72 |
| Accessing the Player Screen | 72 |
| Player Screen | 73 |
| Lesson | 74 |
| Concert Magic | 76 |
| Recorder Detailed Functions | 77 |
| Recorder screen | 77 |
| Overdubbing | 78 |

Adjustments & Settings

| | |
|------------------------------------|-----------|
| Menu | 80 |
| Menu Item List | 80 |
| Speaker/Headphone settings | 81 |
| 4 Hands Mode settings | 86 |
| Bluetooth settings | 88 |
| USB Memory Recorder Settings | 90 |
| User Data Settings | 92 |
| System Settings | 92 |

Appendix

| | |
|--|------------|
| Troubleshooting | 94 |
| Sound List | 98 |
| Drum Rhythm List | 100 |
| Sound Demo Song List | 101 |
| Connecting to Other Devices | 102 |
| Assembly Instructions | 104 |
| Specifications | 108 |

Part Names and Functions

<CA901>

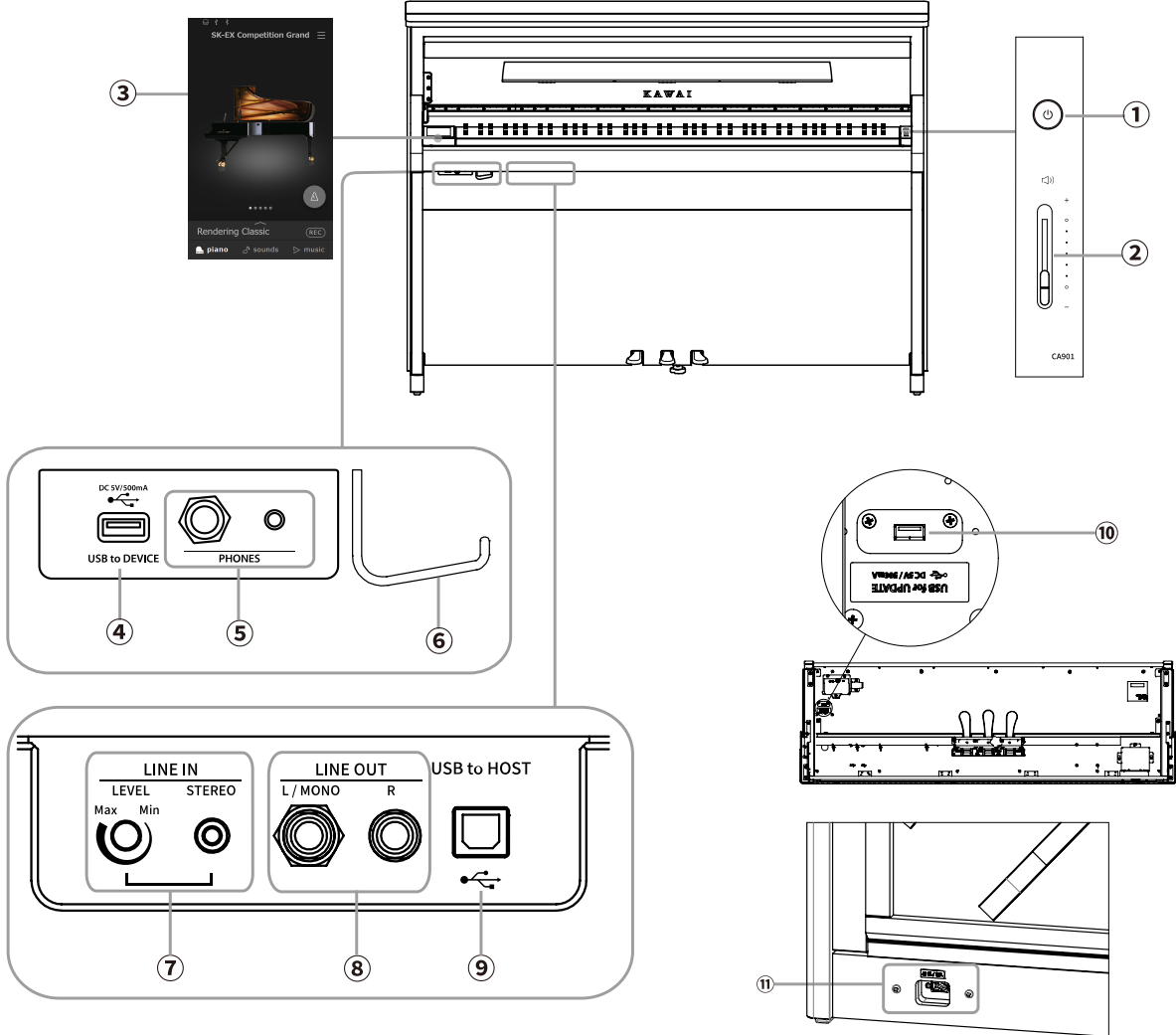

<CA701>

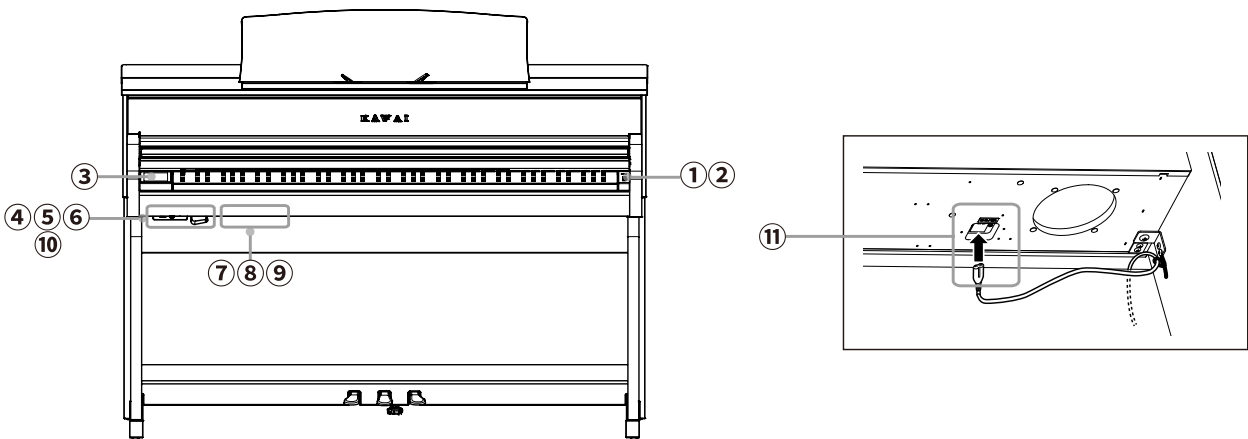

① [POWER] button

This button is used to turn the digital piano on/off. Be sure to turn off the instrument after playing.

② [MASTER VOLUME] slider

This slider controls the master volume level of the digital piano's built-in speakers or headphones, if connected.

③ Display/Touch panel

Use the display/touch panel to select functions using the buttons and icons displayed on the screen, and adjust settings for those functions. The display/touch panel also displays settings status information such as the names of selected sounds, USB memory devices, and Bluetooth connectivity.

CHECK

A transparent sheet has been applied to the display/touch panel. Remove the transparent sheet before use.

④ [USB TO DEVICE] port

This port is used to connect a USB memory device.

⑤ [PHONES] jacks

These jacks are used to connect stereo headphones to the digital piano. Mini stereo plug and standard stereo plug connectors are provided for convenience, and both can be used simultaneously, allowing two pairs of headphones to be connected at the same time.

⑥ Headphone hook

This hook can be used to hang headphones when not in use.

⑦ [LINE IN] jacks

These jacks are used to connect to the output jacks of other electronic instruments or audio equipment to output sound from the external equipment through the speakers of this instrument.

⑧ [LINE OUT] jacks

These jacks are used to output sound from this instrument through other external equipment such as mixers or amplifiers, or when recording on audio equipment.

⑨ [USB TO HOST] port

This port is used to connect the instrument to a computer using a USB "B to A" type cable in order to send and receive MIDI data.

⑩ [USB for UPDATE] port

This port is used to connect a USB memory device used to update the touch panel.

⑪ [AC INLET] jack

This jack is used to connect the power cable.

Opening/Closing the Key Cover

CA901

To open the key cover, gently lift it with both hands.
To close the key cover, gently lower it with both hands.

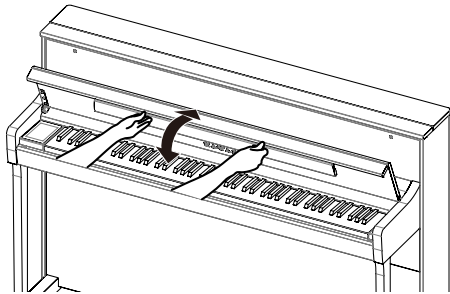

CA701

To open the key cover, gently lift it with both hands, and then slowly push it back into the instrument's body.

To close the key cover, slowly pull the handle toward you with both hands, and then gently lower it.

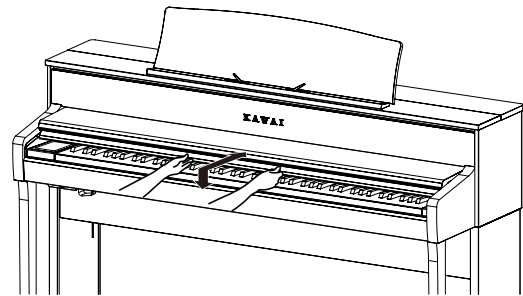

CHECK

- Do not place anything on top of the key cover when opening the key cover. Items may fall inside the instrument, resulting in electric shock, short-circuit, fire, or malfunction.
- Take care that fingers and hands do not get trapped in the space between the key cover and the body of the instrument.

CA901

- Closing the key cover with the music rest down may damage the music rest or the keyboard. Fold up the music rest before closing the key cover.
- The key cover is designed to close slowly with a built-in slow-down mechanism. However, there is no slowing effect when the key cover is only slightly open. Do not take your hands off from the key cover until it has been fully opened or closed.
- When closing the key cover, stand the upper part of the key cover toward you.

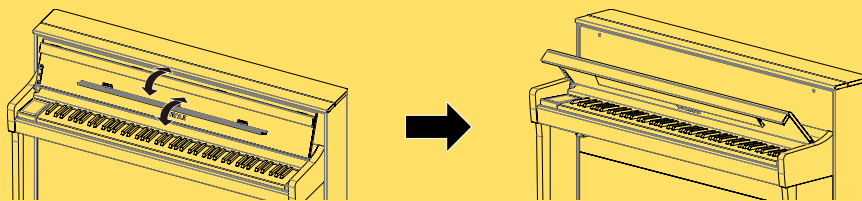

Music Rest

CA901

Use the music rest by tilting it forward.

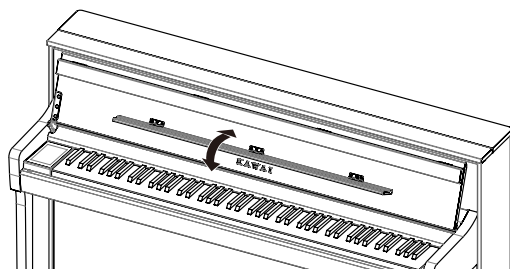

CA701

1. Raise the music rest forward.
 2. Fix the metal fittings on the back of the music rest in the desired location on the holder on top of the instrument.
(The angle can be adjusted in six steps with the two types of music rest fittings.)
- The score support pins can fix musical scores in place.

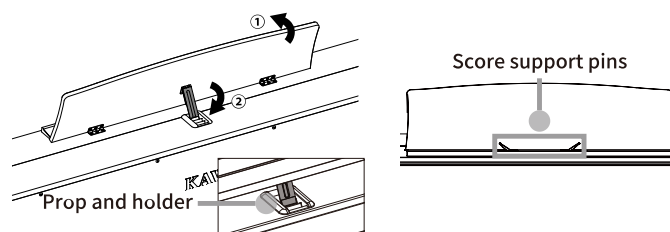

Pedals

As with a grand piano, this piano features three pedals. These pedals produce the following effects.

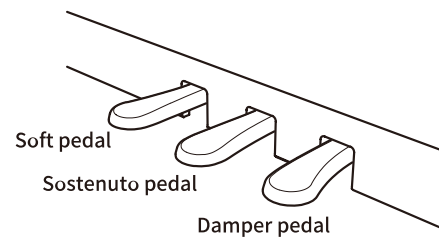

Damper pedal (right pedal)

Depressing this pedal sustains the sound after one's hands have been lifted from the keyboard – greatly enriching the piano sound, while also assisting smooth “legato” passages. The sustain pedal is capable of responding to half pedaling.

Sostenuto pedal (centre pedal)

Depressing this pedal after playing the keyboard and before releasing the keys, sustains the sound of only those notes that were played at that moment. Any keys that are subsequently played after the sostenuto pedal is depressed will not be sustained.

Soft pedal (left pedal)

Depressing this pedal softens the sound, reducing its volume. When the Jazz Organ sound is selected, the soft pedal is also used to alternate the speed of the rotary simulation between “Slow” and “Fast” effect modes.

CHECK

Depending on the sound, the effect may be difficult to notice.

Adjustor Bolt

An adjustor bolt is attached to the pedal board. Make sure to turn the adjustor bolt until it makes full contact with the floor. The pedal board may be damaged if the adjustor bolt is not in full contact with the floor or is too strongly pressed against the floor.

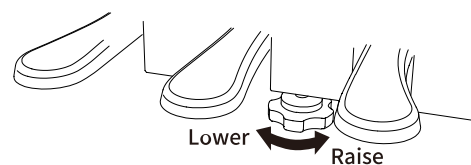

Grand Feel Pedal System

This digital piano features the Grand Feel Pedal System, which replicates the sustain, soft, and sostenuto pedal weighting of an SK-EX Concert Grand piano.

Power

1. Connecting the power cable to the instrument

CA901

Insert the included power cable into the [AC INLET] terminal at the bottom of the back of the body of the instrument.

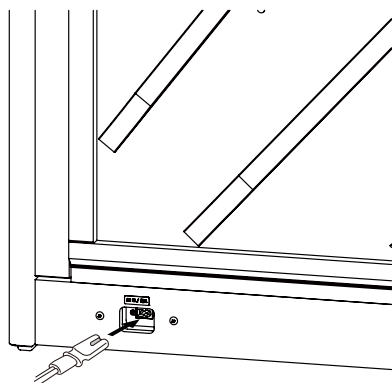

CA701

Connect the included power cable to the underside of the body of the instrument.

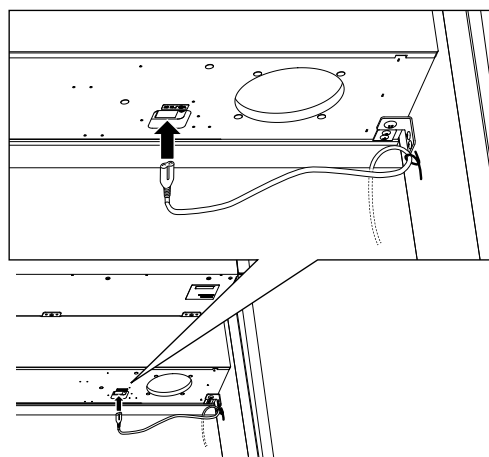

2. Connecting the power cable to an outlet

Connect the power cable to an AC100V outlet.

3. Turning on the power

Press the [POWER] button to turn on the power. "KAWAI" will be shown on the display, and startup will begin. The screen on the right will appear at startup.

When turning the power off, press the [POWER] button again.

CHECK

Do not turn off the power until startup is finished. Also, do not unplug the power cable until the display on the screen has disappeared.

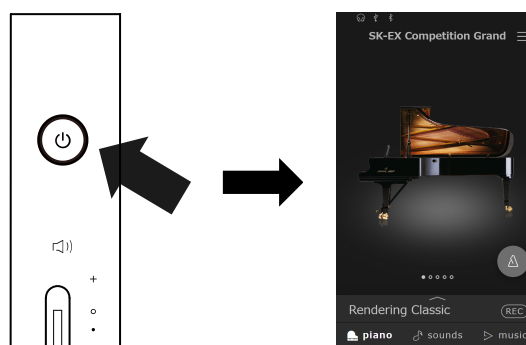

Volume and Headphones

Adjusting the volume

The [MASTER VOLUME] slider controls the volume. Move the slider up to increase the volume, and down to decrease the volume. Adjust the volume by checking the sound while playing the keyboard.

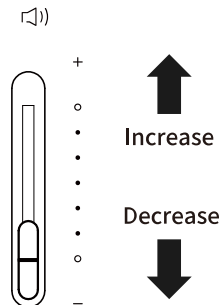

Using headphones

Connect the headphones to the [PHONES] jacks on the underside of the instrument. When headphones are connected, sound will no longer be produced by the instrument's speakers.

 appears at the top of the display when headphones are connected to the instrument.

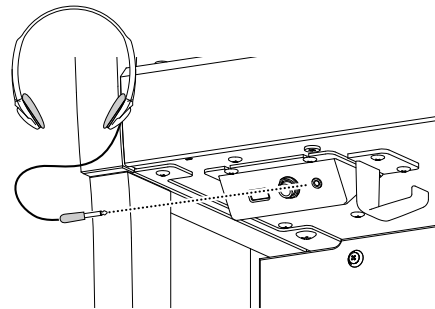

Using the headphone hook

When not using headphones, the included headphone hook can be used to hold headphones. To use the headphone hook, attach it to the instrument as shown in the illustration.

CHECK

Do not hang anything other than headphones on the headphone hook. Doing so may result in damage.

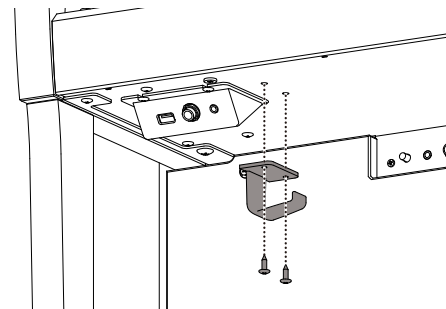

M E M O

Home screen

The digital piano's user interface is arranged into three different "home" screens, which are selected by tapping the corresponding Piano, Sound, and Music tabs shown at the bottom of the touchscreen display.

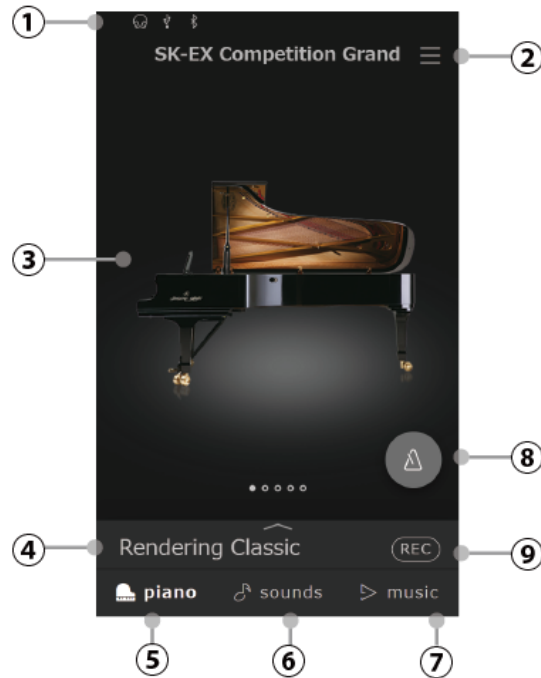

Touchscreen Operations

| Icon | Operation | Description |
|------|-----------|--|
| | Tap | Touch an area of the screen (e.g. an icon or button) and release it immediately. |
| | Swipe | Touch the screen and slide your finger to the left or right. |
| | Scroll | Touch the screen and slide your finger up or down. |
| | Drag | Touch and hold an icon or button, slide your finger to another position, then release. |

① Status bar

This area indicates the status of connected devices (headphones, USB, Bluetooth).

 : This icon is displayed when headphones are connected.

 : This icon is displayed when a USB memory device is connected to the [USB TO DEVICE] port.

 : This icon is displayed when the Bluetooth setting is turned on.

② Settings Menu

This button is used to display the menu, which provides access to various functions and settings that control the digital piano.

③ Selection area

This area is used to select the desired sound or piece of music. The selection area will change depending on the current “home” screen. By default, the digital piano will always start-up with the Piano screen, however this behaviour can be changed via the System settings menu.

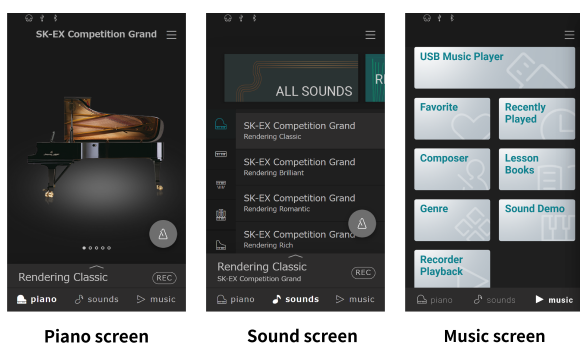

④ Selection bar

This area displays the name of the currently selected sound/variation or piece of music. Tap this area to display information about the current sound/piece of music, make adjustments, or show additional options.

⑤ Piano Tab

This tab is used to access all of the available acoustic piano sounds. This tab is recommended for acoustic piano performance.

⑥ Sound Tab

This tab is used to access all of the available sounds, including acoustic pianos, electric pianos, organs, strings, etc.

⑦ Music Tab

This tab is used to access the wide range of music built into the digital piano. This tab is also used to play music stored on a USB memory device, or recorded to the internal memory.

⑧ Metronome

This button is used to start/stop the Metronome, and open the metronome settings window.

 (blue) : The Metronome is counting.

 (gray) : The Metronome is stopped.

⑨ Recorder

This button is used to change the state of the recorder.

 (Inactive): The Recorder is not in use.

 (Standby): The Recorder is in standby, and will start by tapping the button again, or pressing a key on the keyboard.

 (Recording): The Recorder is recording.

Piano Tab

This tab is used to access all of the available acoustic piano sounds. This tab is recommend for acoustic piano performance.

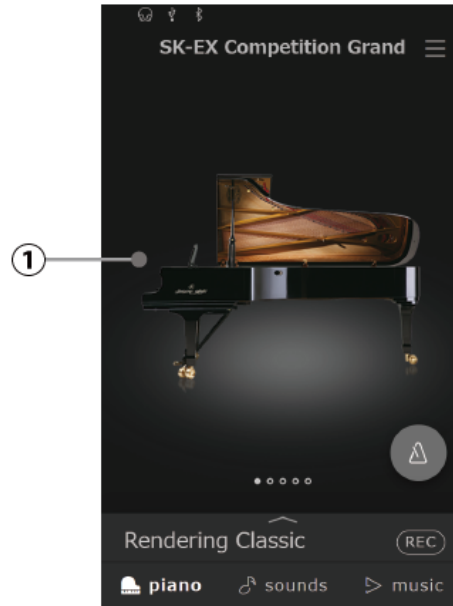

① Piano Selection area

Operation :  

The name and picture of the currently selected piano is shown in this area. The sound can be changed by tapping or swiping.

Piano Selection area List

SK-EX Competition Grand



A concert grand piano with a tone similar to that heard in international piano competitions.

SK-EX Concert Grand



A concert grand piano with a clear tonal color and rich powerful bass.

EX Concert Grand



A concert grand piano with an elegant detailed tone and exceptionally broad dynamic range.

SK-5 Grand Piano



A medium-sized grand piano with a polished brilliant tone.

Upright Piano



A full-bodied traditional upright piano.

Sound Tab

This tab is used to access all of the available sounds, including acoustic pianos, electric pianos, organs, strings, etc.

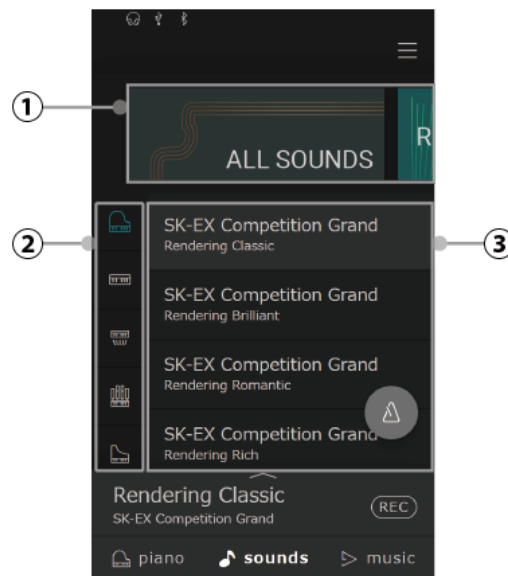

① Category Selection area

Operation:  

The name and picture of the currently selected sound category is shown in this area. The sound can be changed by tapping or swiping.

② Instrument type

Operation:  

When the “All Sounds” category is selected, this area lists the available instrument types (piano, organ, strings, etc.).

(“All Sounds” category only)

③ Sound list

Operation:  

This area lists the available sounds in each category.

 P.98 Sound List

Category Selection area List

All Sounds



All of the sounds available, organised by instrument type.

User



Sounds that have been adjusted and stored using the Piano Editor/Sound Editor.

P.54 Saving User sounds

Favorite



Sounds that have been specified as a Favorite using the Piano Editor/Sound Editor.

P.23 Favorite

Recently Played



Sounds that have been selected previously (up to 30 sounds).

Recommended



Sounds (30 sounds) that are recommended by Kawai.

Classic



Sounds that are suitable for playing Classical music.

Jazz



Sounds that are suitable for playing Jazz music.

Pop



Sounds that are suitable for playing Pop music.

CHECK

- The “User” and “Favorite” categories will only be displayed if a User sound has been stored or a sound has been specified as a Favorite.
- The “Recently Played” category will remember up to 30 sounds. When the history exceeds 30 items, the bottom-most sound will disappear.

M E M O

Music tab

This tab is used to access a wide range of music built into the instrument. This tab is also used to play music stored on a USB memory device, or recorded to the internal memory.

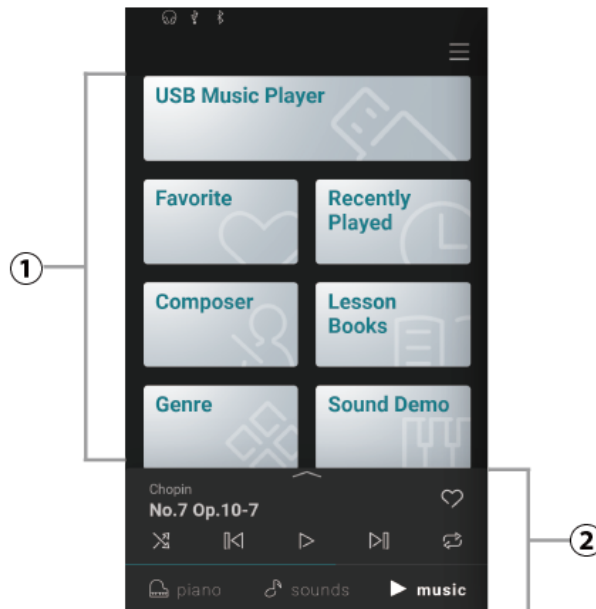

① Category selection

Operation :  This area provides access to the various built-in songs/pieces organised by category, as well as songs recorded to the instrument's internal memory or a USB memory device.

② Mini player

Operation :  This area controls the playback of built-in songs/pieces, and songs recorded to the instrument's internal memory or a USB memory device.

Category selection List

Favorite



Songs/pieces that have been specified as a Favorite.

Recently Played



Songs/pieces that have been played previously (up to 30 pieces).

Composer



Songs/pieces sorted by composer.

Lesson Book



Songs/pieces sorted by lesson book.

Genre



Songs/pieces sorted by musical genre.

Sound Demo



Songs/pieces to demonstrate different instrument sounds.

Recorded songs



Songs/pieces recorded to the instrument's internal memory, or saved to a USB memory device.

USB memory player



Songs/pieces that saved to a USB memory device.

CHECK

- The "Favorites" and "Recently Played Songs" categories will not be displayed if there are no applicable songs.
- The "Recently Played" category will remember up to 30 songs/pieces. When the history exceeds 30 items, the bottom-most song/piece will disappear.
- The "Recorder Playback" category will only be displayed if a song/pieces that has been recorder to the instrument's internal memory.

Playing a song/piece

1. Tap and select a category corresponding to the song/piece to be played.
2. Tap the song/piece to be played.

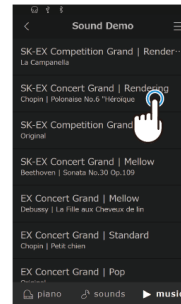
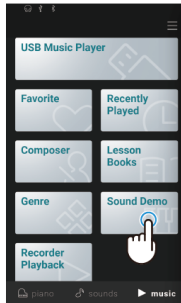



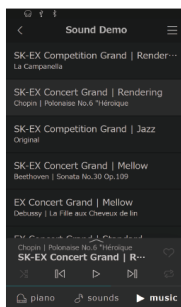



3. The Mini player will appear and play the selected song/piece.



Mini player button

The following operations are possible with the mini player.

-  (Replay) : Play the selected song/piece.
-  (Pause) : Pause song/piece playback.
-  (Backward) : Jump to the previous song/piece.
-  (Forward) : Jump to the next song/piece.
-  (Repeat Playlist) : Repeat the current playlist continuously.
-  (Shuffle) : Automatically select and play songs/pieces from the current playlist at random.
-  (Favorite) : Specify the current playlist a Favorite.

Changing the Sound and Playing a Song

The piano's built-in songs can be played using sounds selected with the Piano tab and Sound tab.

✓ CHECK

Sound Demo songs cannot be played using changed sounds.

Example

Playing the built-in song "La Candeur" with the "Celesta" sound

1. Select "Celesta" in the sound tab.

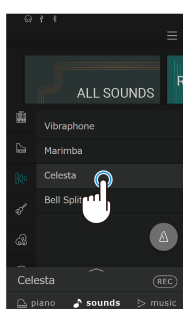

2. In the Music tab, select "Burgmüller" in the "Composer" category, and then select "La Candeur".

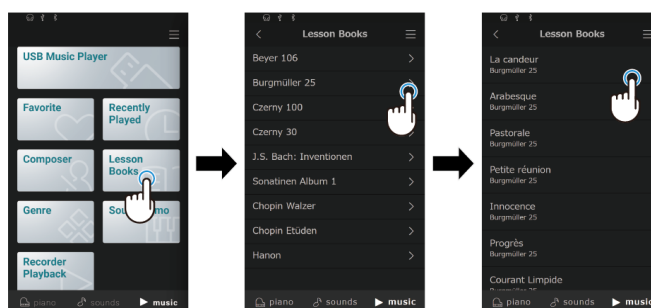

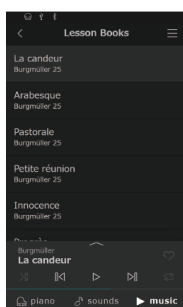

"La Candeur" is played with the "Celesta" sound.



Metronome

The Metronome function provides a steady beat to aid practicing the piano.

Turning the Metronome on/off

- Tap the  (gray) button to start the metronome counting.
- Tap the  (blue) button again to stop the metronome counting.

Metronome mode settings screen

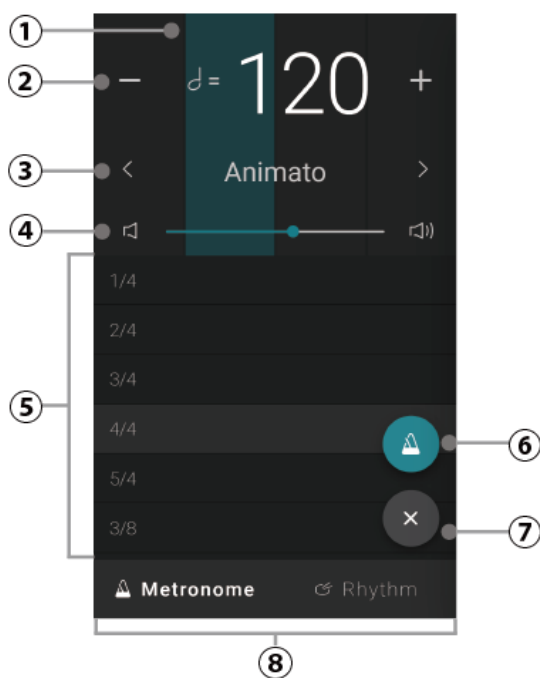

Rhythm mode settings screen

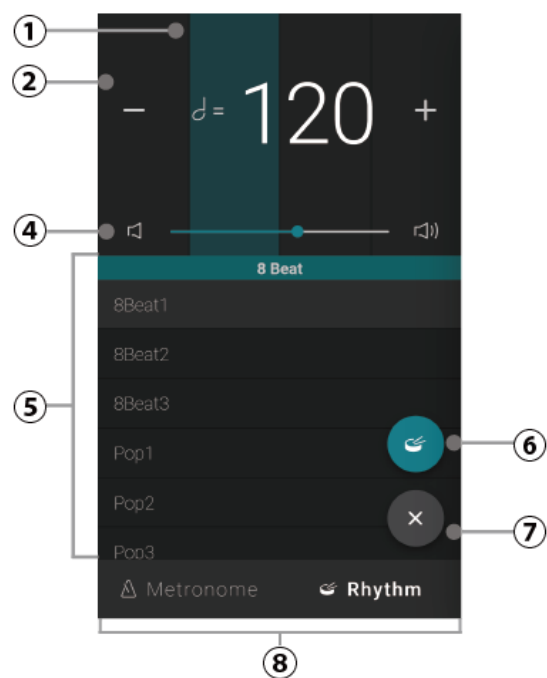

Settings screen operation

① Beat indicator

This area indicates the current beat of the bar by flashing sections of the background in sequence.

② Tempo

Operation:   



This area indicates the Metronome and Rhythm tempo in BPM.

Tap the [-] [+] buttons or swipe left/right to adjust the tempo in single beat intervals. The metronome tempo can be adjusted within the range of 10~400 BPM.

Swipe up/down to adjust the value in 10 beat intervals.

③ Tempo term

Operation: 

This area indicates the Metronome tempo term. Tap the   buttons to change the preset tempo term.
(Metronome only)

④ Volume

Operation: 

This slider indicates the Metronome and Rhythm volume. Drag the slider right/left to increase/decrease the Metronome and Rhythm volume.

⑤ Time signature/Rhythm

Operation: 

This area indicates the current Metronome time and drum Rhythm signature. Swipe up/down to scroll through the list, then tap the desired time signature to select it.

The following Metronome time signatures can be selected: 1/4, 2/4, 3/4, 4/4, 5/4, 3/8, 6/8, 7/8, 9/8, 12/8.

⑥ Start/Stop button

Operation: 

This button indicates the Metronome and Rhythm state. Tap this button to start/stop the Metronome and Rhythm counting.

⑦ Close button

Operation: 

Tap this button to close the Rhythm settings screen and return to the Piano/Sound tab home screen. The Metronome and drum rhythm will continue to play, allowing the sound to be changed, or for the Recorder to be used etc.

⑧ Mode selection button

Operation: 

This area indicates the current Metronome and Rhythm mode. Tap to switch between Metronome and Rhythm mode.

Recorder

This instrument allows songs to be recorded and played back.

Mini Recorder screen

The Mini Recorder appears as the  button on the right side of the Selection bar, on the Piano/Sound tab home screens. This button provides a quick way to start and stop recording without opening the main Recorder screen. This recording method also allows the sound to be changed or the Metronome enabled during recording.

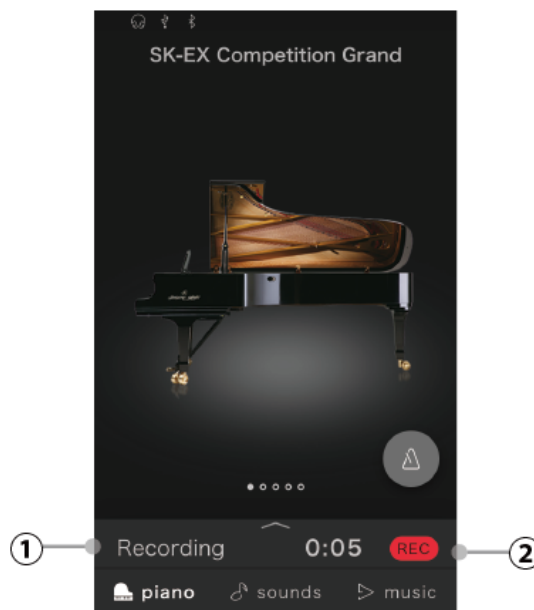

① Recording status

This area indicates the Recorder status. When the Recorder is in use (Standby, Recording), tap this area to open the Recorder screen. When the Recorder is not in use, the selected sound name will be shown.

② Recorder button

Operation: 

This button is used to change the state of the Recorder.

 (Inactive) : The Recorder is not in use.

 (Standby) : The Recorder is in standby, and will start with the next key press.

 (Recording) : The Recorder is recording.

Recording a song

1. Tap the **REC** button on the Piano/Sound tab home screen.

The button will change to **REC** to indicate that the Recorder is in standby mode.

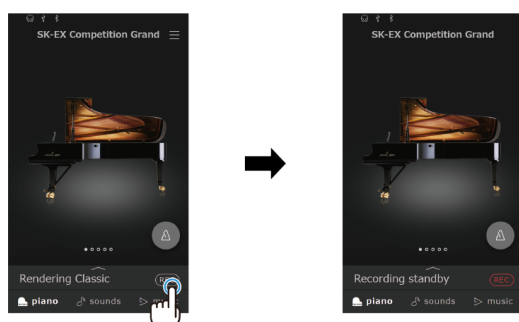

2. Tap the **REC** button, or press a key on the keyboard to start recording.

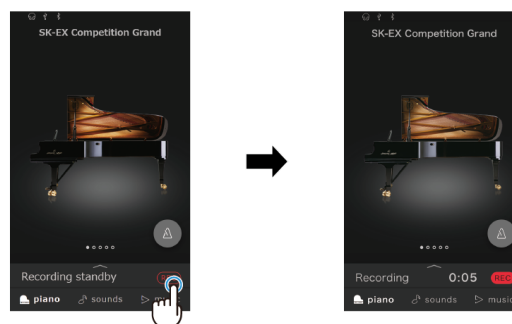

3. Tap the **REC** button again to stop recording. The Recording completed screen will appear.

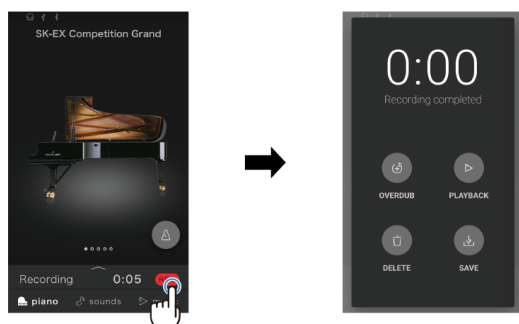

4. Tap the [Playback] button to playback the recorded performance.
Tap the [Save] button to save the recorded performance, or the [Delete] button to delete it.

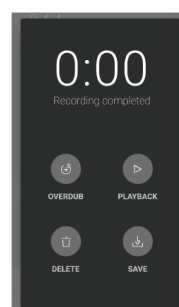

CHECK

Depending on the selected recording format, the recorded performance will be saved to either the instrument's internal memory or a USB memory device.

Internal Recorder

- This instrument allows up to 10 songs to be recorded and stored in internal memory.
- The total recording capacity of this instrument is approximately 90,000 notes.
- Performances are recorded until immediately before the recorder stops.
- The Recorder will capture sound changes during recording.
- The Recorder will capture switching to Dual or Split playing mode.
- The Recorder will not capture changes to the Metronome tempo settings made during the recording. Performances will be recorded at the tempo specified immediately before recording.

CHECK

Approximate guide for the total recording capacity:

For reference, a 5000 note recorder capacity would be sufficient to record the Beethoven piece 'Für Elise' approximately 3-4 times, which is the equivalent of 10 to 15 minutes of recording. However, the total recording time will change depending on the number of notes played and the tempo of the piece. In addition, pedal presses will also influence the maximum recording length, with each pedal press the equivalent of one note.

Recording to a USB memory device

- This instrument is capable of recording performances directly to a USB memory device in audio format.
- When recording a WAV or MP3 audio file to a USB memory device, the metronome/drum rhythm sound will not be recorded.

Editor

The Editor allows various aspects of the current piano sound to be adjusted.

Accessing the Editor screen

Access the Editor screen by tapping the selected content bar on the Piano tab screen or Sound tab screen.

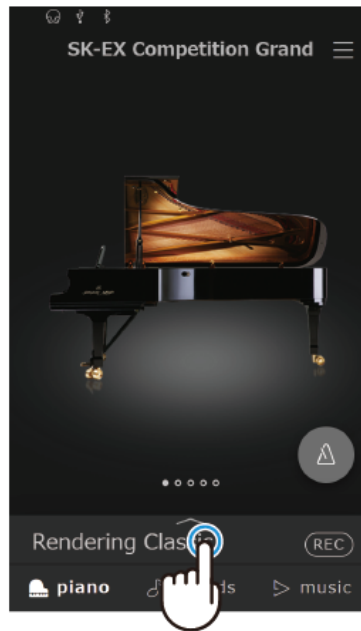

Piano Variation

CHECK

"Piano Variation" is only shown when the Piano tab is selected.

Changing Piano Variation

In "Piano Variation", tap the   buttons to change the piano sound.

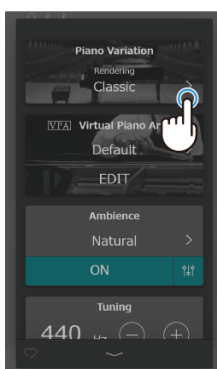

SK-EX Competition Grand / SK-EX Concert Grand

| Piano Variation | Description |
|---------------------|--|
| Rendering Classic | A standard grand piano sound with a broad dynamic range. |
| Rendering Brilliant | A bright grand piano sound with emphasised treble. |
| Rendering Romantic | A mellow grand piano sound with soft hammers. |
| Rendering Rich | A rich grand piano sound with emphasised resonances. |
| Rendering Vintage | A soft grand piano sound with a vintage character. |
| Concert | A standard grand piano sound with a broad dynamic range. |
| Jazz | A grand piano sound with a thick and clear character. |
| Mellow | A soft and warm grand piano sound. |

MEMO

About Rendering sounds

The sound of a grand piano is comprised of various elements that interact to create a rich, harmonious tone.

Rendering sounds reproduce different types of pianos by reconstructing each of these elements using a combination of high-resolution multi-channel sampling and advanced modelling algorithms.

EX Concert Grand

| Piano Variation | Description |
|-----------------|---|
| Concert | A luxurious and fluent grand piano sound. |
| Mellow | A soft and warm grand piano sound. |
| Standard | A distinctive and bright grand piano sound. |
| Pop | A bright and powerful grand piano sound. |
| Bright | A bright and exciting grand piano sound with a characteristic attack. |
| New Age | A clear and transparent grand piano sound. |
| Modern | A transparent grand piano sound that is suitable for performing modern music. |

SK-5 Grand Piano

| Piano Variation | Description |
|-----------------|--|
| Classical | A lustrous grand piano sound that is crisp and distinctive. |
| Jazz | A thick and vintage grand piano sound. |
| Pop | A strong and distinctive grand piano sound that is suitable for pop music. |

Upright Piano



| Piano Variation | Description |
|-----------------|--|
| Classical | A deep upright piano sound that produces a feeling of nostalgia. |
| Boogie | A thick and vintage upright piano sound. |
| Vintage | A soft upright piano sound that produces a sense of melancholy. |
| Honky Tonk | A bright upright piano sound with a detuned character. |

Main Sound

CHECK

"Main Sound" is displayed only when the Sound tab is selected.

Main Sound settings

1. In "Main Sound", swipe the icons left/right to scroll through the available instrument types, then tap the desired icon to select it.
2. Tap the   buttons to change the selected sound.

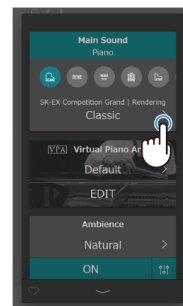

CHECK

Dual mode and Split mode will not be displayed when a Rendering sound variation is selected.

Sub Sound

✓ CHECK

"Sub Sound" is only shown when an item other than a Rendering is selected in the Sound tab.

Dual mode

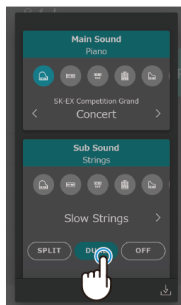

The Dual playing mode allows two sounds to be layered together, creating a more complex sound. For example, a piano sound layered with strings, or a church organ combined with a choir, etc.

1. Tap the [Dual] button in "Sub Sound".

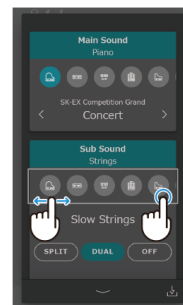

2. In the Sub Sound area, swipe the icons left/right to scroll through the available instrument types, then tap the desired icon to select it.



3. Tap the   buttons to change the selected sound.

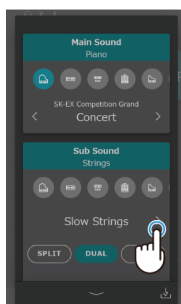

Dual mode advanced settings

When Dual playing mode is selected, the following settings can be changed.

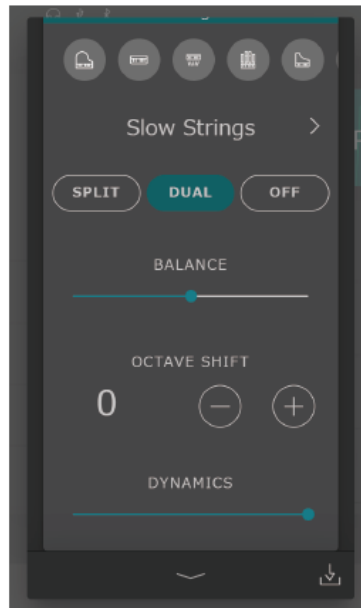

Balance

This setting is used to adjust the volume balance between the Main and Sub sounds.

Drag the Balance slider  right/left to increase the volume of the Main/Sub sounds.

Octave Shift

This setting is used to lower/raise the pitch of the Sub Sound in octave steps.

Tap the [-] and [+] buttons to change the octave value.

The octave value can be adjusted in increments of 1 octave within the range of -2~2.

Dynamics

This setting is used to adjust the dynamic sensitivity of the Sub Sound relative to the Main Sound.

Drag the Dynamics slider  right/left to increase/decrease the dynamic sensitivity of the Sub Sound.

Split mode

The Split playing mode divides the keyboard into two sections, allowing each section to be played with a different sound.

For example, a bass sound in the left section, and a piano sound in the right section.

1. Tap the [Split] button in "Sub Sound".

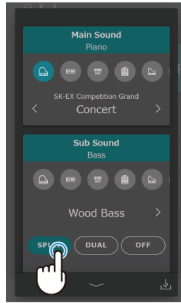

2. In the Sub Sound area, drag the icons left/right to scroll through the available instrument types, then tap the desired icon to select it.

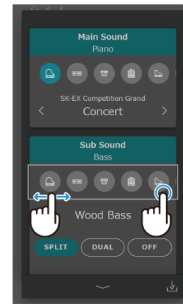

3. Tap the < > buttons to change the selected sound.

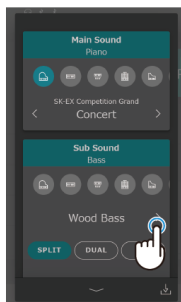

CHECK

If "Split" is selected in the Sub Sound area, the Main Sound will be used for the right section of the keyboard.

Split mode advanced settings

When Split playing mode is selected, the following settings can be changed.

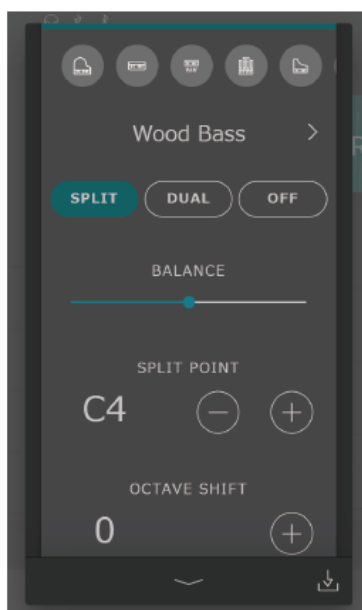

Balance

This setting is used to adjust the volume balance between the Main (right section) and Sub (left section) sounds. Drag the Balance slider  right/left to increase the volume of the Main/Sub sounds.

Split Point

This setting is used to set the point on the keyboard that divides the Main (right section) and Sub (left section) sounds.

Tap the [-] and [+] buttons to change the Split Point.

Octave Shift

This setting is used to lower/raise the pitch of the Sub Sound in octave steps.

Tap the [-] and [+] buttons to change the octave value.

The octave value can be adjusted in increments of 1 octave within the range of 0~3.

Lower Pedal

This setting is used to enable/disable pedal functions for the Sub (left section) Sound.

When turned off, the pedals will only affect the Main (right section) Sound, and not the Sub (left section) Sound.

CHECK

The pedal functions will always affect the Main (right section) Sound.

VPA



An experienced piano technician is essential to fully realise the potential of a fine acoustic piano. In addition to meticulously tuning each note, the technician also performs numerous regulation and voicing adjustments that allow the instrument to truly sing.

The VPA (Virtual Piano Artisan) of the digital piano simulates these refinements digitally, allowing performers to shape various aspects of the instrument's character to suit their personal preferences.

✓ CHECK

- "VPA" is displayed only when a piano sound is selected.
- When a non-piano sound is selected, the "VPA" area will be replaced by an "Other sound settings" area, which contains similar adjustable settings.

Changing VPA presets

In "VPA", tap the   buttons to change the presets.

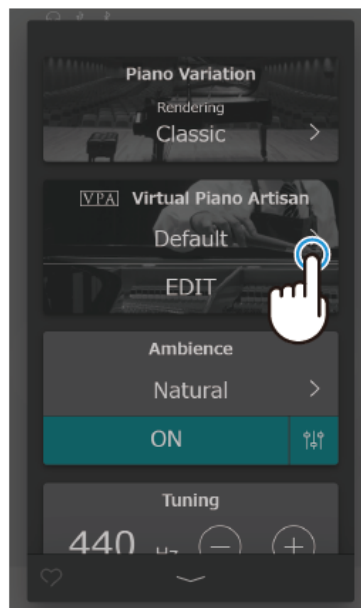

Presets

| Item | Description |
|-----------------|---|
| Default | The default piano sound without additional adjustments. |
| Noiseless | A preset that eliminates the mechanical noises produced when the damper pedal is depressed and keys are released. |
| Deep Resonance | A preset that emphasises damper and string resonances. |
| Light Resonance | A preset that reduces damper and string resonances. |
| Soft | A preset that softens the hammers and increases the touch weight of the keyboard in order to produce a softer tone that is suitable for slow, quiet pieces. |
| Brilliant | A preset that hardens the hammers in order to produce a brighter tone suitable for modern pieces. |
| Clean | A preset that hardens the hammers and reduces damper and string resonances. |
| Full | A preset that emphasises dynamics, with a lightened keyboard touch and powerful damper and string resonances. |
| Dark | A preset that hardens the hammers and increases the touch weight of the keyboard, in order to produce a dark, gloomy tone. |
| Rich | A preset that lightens the touch weight of the keyboard and increases damper and string resonances. |
| Historical | A preset suitable for romantic, classical music, with a bright, open tone. |
| User | This preset will be selected automatically when any of the above presets are adjusted using the edit screen. |

Ambience

This function can be used to apply Ambience to the current sound, in order to simulate various different virtual environments.

✓ CHECK

"Ambience" is only shown when a Rendering sound is selected in Piano Variation.

Changing Ambience

1. In "Ambience", tap the [On/Off] button to switch the Ambience simulation on and off.

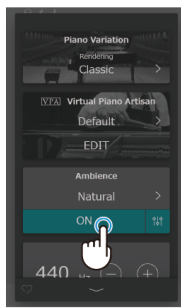

2. In the Ambience area, tap the < > buttons to change the Ambience type.

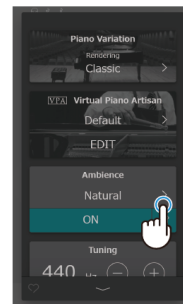

3. In the Ambience area, tap the  button to display the slider  for controlling Depth.

Drag the Depth slider right/left to increase/decrease the depth of the Ambience simulation.



Ambience types

| Type | Description |
|---------------|--|
| Natural | Simulates the ambience of a natural environment. |
| Small Room | Simulates the ambience/reverberation of a small room. |
| Medium Room | Simulates the ambience/reverberation of a medium-sized room. |
| Large Room | Simulates the ambience/reverberation of a large room. |
| Mellow Lounge | Simulates the soft ambience/reverberation of a lounge. |
| Bright Lounge | Simulates the bright ambience/reverberation of a lounge. |
| Studio | Simulates the ambience/reverberation of a recording studio. |
| Wood Studio | Simulates the ambience/reverberation of a wooden recording studio. |
| Live Stage | Simulates the ambience/reverberation of a live stage. |
| Echo | Simulates the ambience/reverberation of an echo chamber. |

Reverb

This function can be used to apply Reverberation to the current sound, in order to simulate various different virtual environments.

✓ CHECK

"Reverb" is only shown when an item other than a Rendering sound is selected in Piano Variation.



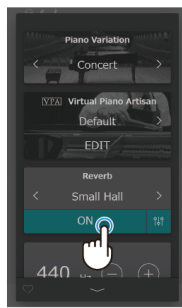

Changing Reverb

1. In "Reverb", tap the [On/Off] button to switch the reverb on and off.

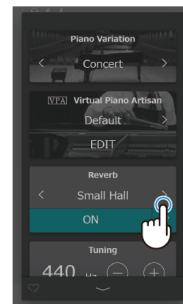

2. In the Reverb area, tap the < > buttons to change the Reverb type.



3. In the Reverb area, tap the  button to display the slider  for controlling Time and Depth. Drag the Time slider  right/left to increase/decrease the decay length of the Reverb simulation. Drag the Depth slider  right/left to increase/decrease the depth of the Reverb simulation.

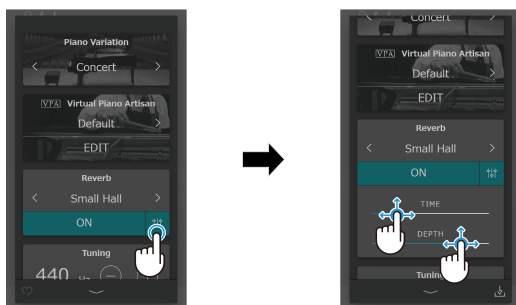

Reverb types

| Type | Description |
|--------------|--|
| Room | Simulates the reverb of a small rehearsal room. |
| Lounge | Simulates the reverb of a piano lounge. |
| Small Hall | Simulates the reverb of a small hall. |
| Concert Hall | Simulates the reverb of a concert hall or theatre. |
| Live Hall | Simulates the reverb of a live hall or stage. |
| Cathedral | Simulates the reverb of a large cathedral. |

Effect

This function can be used to apply a variety of effects to the current sound, in order to simulate various different digital and analogue effects units.

✓ CHECK

"Effect" is only shown when an item other than a Rendering sound is selected in the Sound tab.

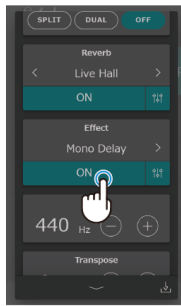

Changing Effect

1. In "Effect", tap the [On/Off] button to switch the effect on and off.

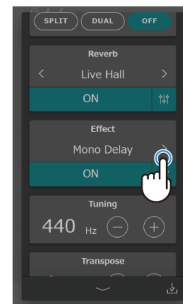

2. In the Effect area, tap the < > buttons to change the Effect type.



3. In the Effect area, tap the  button to show additional settings for controlling the selected effect. Drag the various sliders  right/left to change the values.

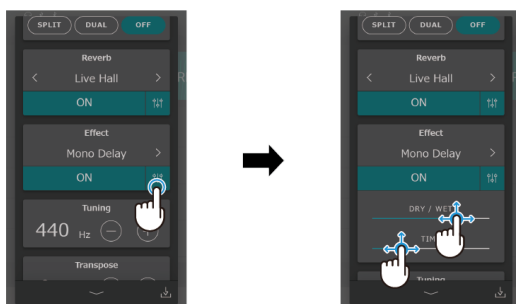

Effect types

| Type | Description |
|-------------------|---|
| Mono Delay | Applies an echo effect to the sound, playing through both speakers simultaneously. |
| PingPong Delay | Applies a “ping pong” echo effect to the sound, giving the impression that it is “bouncing” from left to right. |
| Triple Delay | Similar in principle to PingPong Delay, but with an additional centre echo. |
| Chorus | Layers a slightly detuned version of the sound over the original, thus enriching its tonal character. |
| Classic Chorus | Similar in principle to Chorus, but intended for vintage electric piano sounds. |
| Ensemble | Applies a three-phase chorus to the sound, providing additional richness. |
| Tremolo | Continuously varies the volume at a constant speed, adding a tremolo-type effect to the sound. |
| Classic Tremolo | Similar in principle to Tremolo, but intended for vintage electric piano sounds. |
| Vibrato Tremolo | Similar in principle to Tremolo, but with an additional Vibrato effect applied. |
| Tremolo + Amp | Reproduces the changes in sound created by an amp combined with a Tremolo effect. |
| Auto Pan | Alternates the sound output from left to right across the stereo field using a sine wave. |
| Classic Auto Pan | Similar in principle to Auto Pan, but intended for vintage electric piano sounds. |
| Auto Pan + Amp | Reproduces the changes in sound created by an amp combined with an Auto Pan effect. |
| Phaser | Applies a cyclic phase change to the sound, giving the impression that the sound is moving. |
| Classic Phaser | Similar in principle to Phaser, but intended for vintage electric piano sounds. |
| Phaser + Auto Pan | An Auto Pan effect added to a Phaser effect. |
| Phaser + Amp | Reproduces the changes in sound created by an amp combined with a Phaser effect. |
| Phaser + Chorus | A Chorus effect added to a Phaser effect. |
| Rotary 1 | Simulates the sound of a rotary speaker commonly used with vintage electronic organs. The soft pedal (left pedal) can be used to alternate the speed. |
| Rotary 2 | A slightly more distorted effect than Rotary 1. |
| Rotary 3 | A more distorted effect than Rotary 2. |
| Rotary 4 | A Chorus effect added to the Rotary 1 effect. |
| Rotary 5 | A Chorus effect added to the Rotary 2 effect. |
| Rotary 6 | A Chorus effect added to the Rotary 3 effect. |

Effect parameters

Delay

- Dry / Wet: Moving the slider to the right adjusts the intensity of the effect.
- Time: Moving the slider to the right adjusts the interval time between each delay.

Chorus / Ensemble

- Dry / Wet: Moving the slider to the right adjusts the intensity of the effect.
- Speed: Moving the slider to the right increases the fluctuation speed.

Classic Chorus

- Mono / Stereo: Moving the slider to the right adjusts between a Mono and Stereo effect.
- Speed: Moving the slider to the right increases the fluctuation speed.

Tremolo / Auto Pan / Phaser

- Dry / Wet: Moving the slider to the right adjusts the intensity of the effect.
- Speed: Moving the slider to the right increases the fluctuation speed.

Rotary

- Accel. Speed: Moving the slider to the right adjusts the acceleration speed between slow and fast modes.
- Rotary Speed: Moving the slider to the right adjusts the speed of the rotary speaker.

[Effect]+[Effect]

- Dry / Wet: Moving the slider to the right adjusts the intensity of the effect.

[Effect]+Amp

- Speed: Moving the slider to the right increases the fluctuation speed.

Tuning

Adjust the overall pitch of the current sound. This setting may be useful for matching the pitch when playing with an ensemble or playing along with a CD or other audio source.

Changing Tuning

Tap the [+] [-] buttons to change the values in "Tuning". Values can be changed in 0.5 Hz increments within the range of 427~453 Hz.

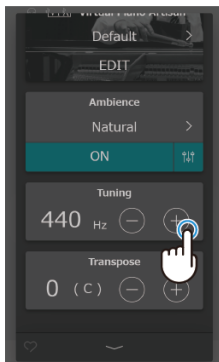

Transpose

Adjust the overall pitch of the current sound in semi-tone steps. This setting may be useful when playing with other instruments tuned for different keys.

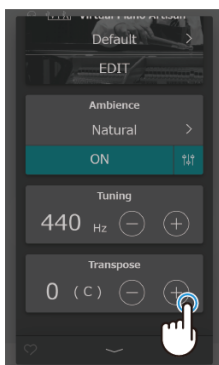

Changing Transpose

Tap the [+] [-] buttons to change the key in "Transpose". The key can be changed in semi-tone increments within the range of -12~12.



Sound Management

Favorite

1. Tap the  button in the bottom left of the screen.
The button colour will change to .
2. The current sound is added to the "FAVORITE" category in the Sound tab.



- Tap the  button again to remove the sound from the "FAVORITE" category.



CHECK

 is not displayed when editing sound settings on the Editor screen. To add an edited sound to the "FAVORITE" category, save the sound first.

P.54 Saving User sounds



Saving User sounds

- When sound settings are edited on the Editor screen, the  button will be shown in the lower right corner of the screen.
- Tap the  button, then enter the desired name for the edited sound.

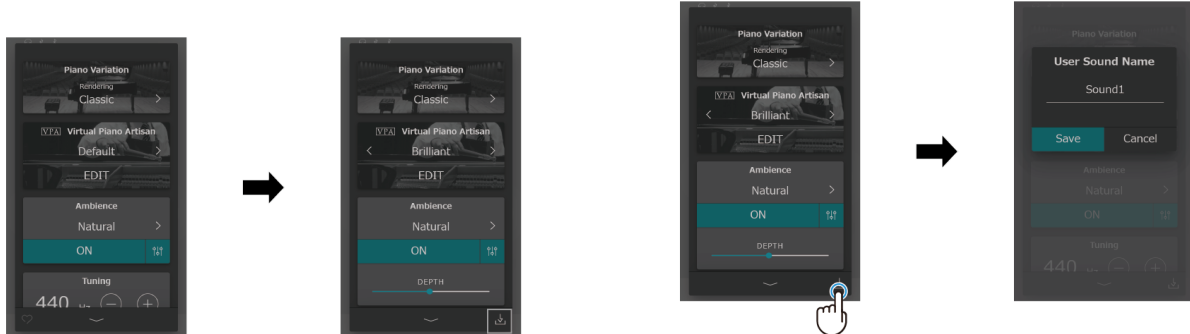

- Tap "Save" to save the sound with the entered sound name, or "Cancel" to cancel. Saving will add the current sound settings to the "User" category as a User sound.

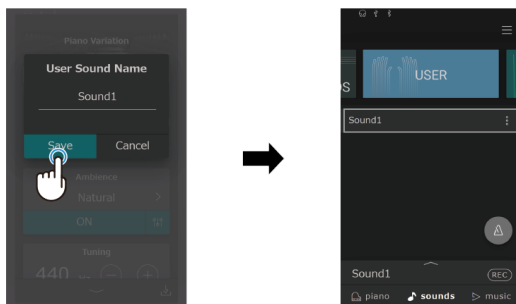

CHECK

If sound settings edited on the Editor screen have not been saved, "(Not saved sound)" will appear on the Selection bar.



Changing the name of a User sound

1. Tap the  button for the sound to be renamed.

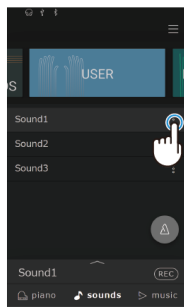

2. Tap "Rename".

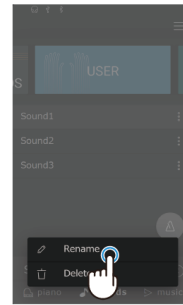

3. Change the name, then tap "Save". The User sound name will be renamed.

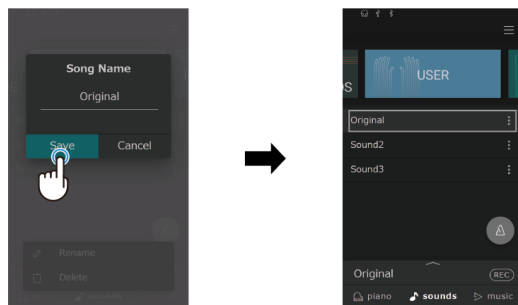

CHECK

Only User sounds can be renamed. The names of preset sounds cannot be changed.

Deleting User sounds

1. Tap the button for the User sound to be deleted.

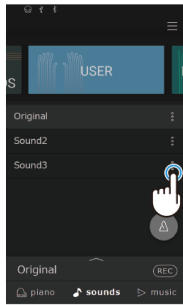

2. Tap "Delete Sound".

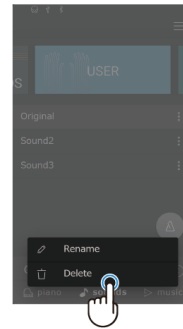

3. Tap "Delete". The User sound will be deleted.

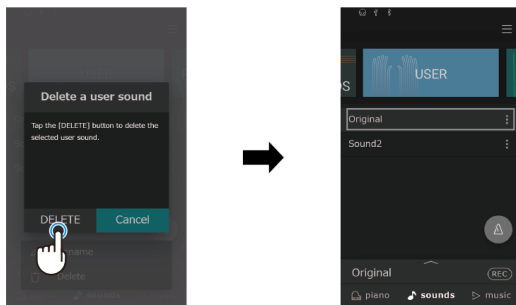

VPA Detailed Settings





An experienced piano technician is essential to fully realise the potential of a fine acoustic piano. In addition to meticulously tuning each note, the technician also performs numerous regulation and voicing adjustments that allow the instrument to truly sing.

The VPA (Virtual Piano Artisan) settings of the digital piano simulate these refinements digitally, allowing performers to shape various aspects of the instrument's character to suit their personal preferences.

CHECK

When a non-piano sound is selected, the “VPA” area will be replaced by an “Other sound settings” area, which contains similar adjustable settings.

VPA Detailed Settings List

| Item | Description | Operation |
|---------------------------|--|---|
| Touch Curve | As with an acoustic piano, the digital piano produces a louder sound when the keys are struck with force, and a softer sound when the keys are played gently. The volume and tonal character change in relation to the strength and velocity of playing on the keyboard is referred to as a “touch curve”. |  |
| Voicing | The Touch Curve setting allows the touch sensitivity of the keyboard to be conveniently adjusted. There are ten different preset touch curve settings available. On an acoustic piano, the shape, density, and texture of the hammers all influence the tonal character of the instrument's sound. Technicians utilise a variety of tools such as needles, files, and brushes to manipulate these hammer felts, with the ultimate goal of achieving a balanced tonal character across the keyboard. The Voicing setting recreates various hammer properties, allowing the overall tonal character of the digital piano to be adjusted. |  |
| Resonance Rendering | On an acoustic piano, the strings vibrate when the keyboard is played or the pedals are depressed, creating a rich resonance. In addition, the resonance sound changes in a complicated manner according to the keyboard touch and the state of the pedals. The Resonance Rendering setting allows the overall resonance effect of the SK-EX Rendering sound engine to be adjusted. |  |
| Damper Noise | When the damper pedal of an acoustic piano is pressed and released, it is often possible to hear the sound of the damper head touching and releasing the strings. The digital piano reproduces this sound, with the Damper Noise setting allowing the volume of this sound to be adjusted. The speed at which the damper pedal is pressed and released will also influence the prominence of the damper noise, with fast pedalling creating a more pronounced sound. |  |
| Undamped String Resonance | The dampers of an acoustic piano span almost the full width of the keyboard. However, the topmost 18 keys (approximately 1.5 octaves) do not incorporate dampers, as the shorter strings for these treble notes decay quickly and therefore do not need to be dampened. As a result, the strings of these “undamped” treble notes are free to vibrate in sympathetic resonance with those of lower keys independently of the damper pedal position – helping to enrich the sound with additional harmonics and tonal colour. The digital piano recreates this phenomenon, with the Undamped String Resonance setting allowing the volume of this resonance sound to be adjusted. |  |

| Item | Description | Operation |
|-------------------|---|---|
| Cabinet Resonance | While the fundamental sound of an acoustic piano is produced by vibrating strings, transmitting energy through a spruce soundboard, the cabinet of the instrument itself also contributes a variety of subtle tonal characteristics that enrich the playing and listening experience. The digital piano recreates these natural acoustic characteristics, with the Cabinet Resonance setting allowing the volume of this resonance sound to be adjusted. |  |
| Key-off Effect | When playing an acoustic piano – particularly in the bass region of the keyboard – if a key is played with force and released quickly, it is often possible to hear the faint sound of the damper touching the strings immediately before the vibrations are stopped. The digital piano recreates this phenomenon, with the Key-off Effect setting allowing the volume of this sound to be adjusted. |  |
| Fall-Back Noise | When playing an acoustic piano, it is often possible to hear the faint sound of the keyboard action returning (i.e., “falling back”) to the neutral position after a key is released. The digital piano reproduces this sound, with the Fall-back Noise setting allowing the volume of this sound to be adjusted. |  |
| Hammer Noise | When playing an acoustic piano, it is also possible to hear the physical sound of the hammers striking the strings, along with the sound of the keys making contact with the piano keyboard. The digital piano reproduces this sound, with the Hammer Noise setting allowing the volume of this sound to be adjusted. |  |
| Hammer Delay | When playing pianissimo passages using an acoustic piano, there may be a perceived delay between a key being pressed and the hammer striking the strings. The digital piano recreates this delay, with the Hammer Delay setting allowing the delay length to be adjusted. |  |
| Topboard | When playing an acoustic grand piano, the position of the instrument’s topboard (lid) affects both the volume and “openness” of the tone produced. The digital piano simulates these characteristics, with five different topboard positions. |  |
| Decay Time | In a grand piano, the length of the decay time of the sound after playing the keyboard differs depending on the length of the strings. The digital piano reproduces this characteristic, with the Decay Time setting allowing the length of decay while keys are pressed to be adjusted. |  |
| Release Time | With a grand piano, the length of time at which the sound decays after the keyboard is released differs depending on the size of the instrument. The digital piano reproduces this characteristic, with the Release Time setting allowing the length of decay after keys are released to be adjusted. |  |
| Minimum Touch | With an acoustic piano, there is a range in which an extremely fine touch on the keyboard does not produce sound. The digital piano reproduces this characteristic, with the Minimum Touch setting allowing the minimum key velocity required to produce a sound to be adjusted. |  |
| Stretch Tuning | Stretch tuning is a piano-specific tuning method used by acoustic piano technicians in which the lower octaves are tuned slightly flatter and the upper octaves are tuned slightly sharper to match the natural harmonics of an acoustic piano. The Stretch Tuning setting allows the degree of stretch tuning to be adjusted with three types of stretch tuning, or for stretch tuning to be completely disabled. It is also possible to create custom tuning methods by adjusting the pitch of each individual key. |  |

| Item | Description | Operation |
|-------------------|---|-----------|
| Temperament | The Temperament setting allows the tuning system used by the digital piano to be changed from the modern “Equal Temperament” standard to one of the various temperaments popularised during the Renaissance and Baroque periods. | |
| Key Volume | The Key Volume setting allows the volume of different regions of the keyboard to be subtly reduced. There are four different damping presets available, with an additional “User” setting allowing players to perform subtle volume adjustments on each individual key. | |
| Half-Pedal Adjust | The Half-Pedal Adjust setting allows the point at which the damper pedal becomes effective (i.e., when the dampers of the piano begin to lift from the strings) to be adjusted. | |
| Soft Pedal Depth | The Soft Pedal Depth setting adjusts the extent to which the soft (left) pedal of the digital piano softens the sound of played notes. | |
| Damper Hold | The Damper Hold setting is used to determine whether sounds such as organ or strings should be sustained continuously when the damper pedal is pressed, or whether these sounds should decay, naturally. (Other detailed settings only) | |

Accessing the VPA Detailed Settings Screen

1. Tap [Edit] in the VPA area.
2. Set the value and type for each item in the detailed settings.

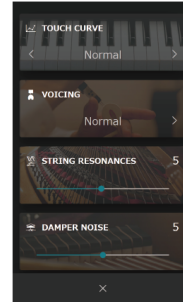
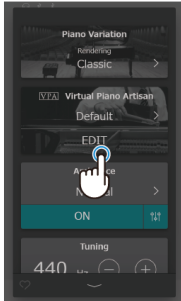

3. Tap  to return to the Editor screen.

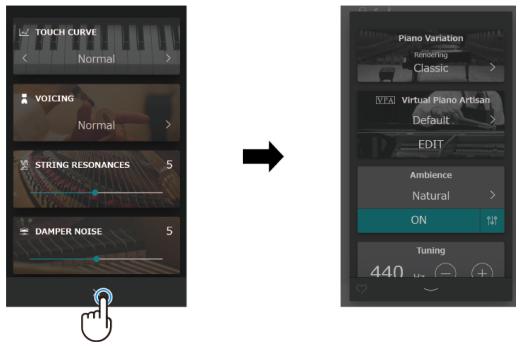

CHECK

Items that can be adjusted differ depending on the sound, and items that cannot be adjusted are hidden.

Touch Curve

| Type | Effect |
|--------------------|--|
| Light (4/3/2/1) | Light touch curves require less striking force to achieve a forte note, and are therefore recommended for players with a delicate touch such as children or organ players. The key touch will become progressively lighter as the number increases. |
| Normal | Reproduces the standard touch sensitivity of an acoustic piano. |
| Heavy (1/2/3/4) | Heavy touch curves require more striking force in order to achieve a forte, and are therefore recommended for producing the delicate nuance of a light touch, or for players with stronger fingers. The key touch will become progressively heavier as the number increases. |
| Off | A constant volume is produced regardless of how hard the keys are struck. |
| User | A custom touch curve, created by moving individual points along the curve. |

Touch Curve Editor

1. Tap [Edit] in the Touch Curve Editor area to display the Touch Curve Editor screen.
2. Select the keystroke strength from ppp to fff with the [+] and [-] buttons, or drag the graph to adjust the curve. Use the [+] and [-] buttons to adjust the sound intensity for each keystroke strength, or drag the graph to adjust the curve.

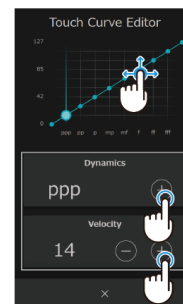
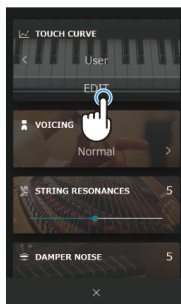

3. Tap the [Reset] button to return to the default settings.



4. Tap  to return to the detailed settings screen.

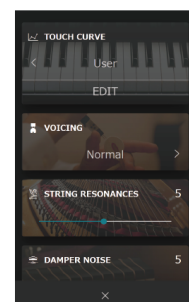
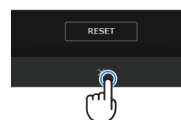

Voicing

| Type | Description |
|----------|---|
| Normal | The normal tonal character of an acoustic piano throughout the entire dynamic range. |
| Mellow 1 | A softer, more mellow tonal character throughout the entire dynamic range. |
| Mellow 2 | An even softer tonal character than Mellow 1. |
| Dynamic | A tonal character that changes dramatically from mellow to bright, depending on the strength of key strike. |
| Bright 1 | A bright tonal character throughout the entire dynamic range. |
| Bright 2 | An even brighter tonal character than Bright 1. |
| User | A custom tonal character, allowing each key to be individually voiced. |

User Voicing

1. Tap [Edit] in the User Voicing area to display the Voicing Editor screen.
2. Tap the [-] and [+] buttons in the Key area to select the desired note to be adjusted, or to select a note directly, press the desired key on the instrument's keyboard.

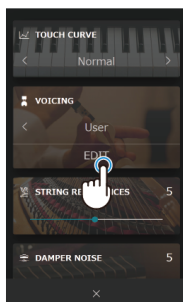

3. Tap the [-] and [+] buttons to select the voicing and adjust the volume, or drag the graph to adjust the voicing.

Tap the [Reset] button to return to the default settings. Tap  to return to the detailed settings screen.

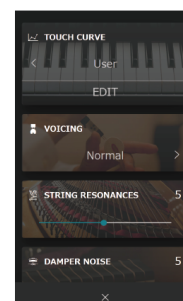
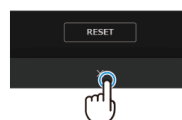

Resonance Rendering

| Value | Description |
|-------|--|
| Off | Resonance will not be applied to the selected sound. |
| 1 | A small amount of resonance will be applied to the selected sound. |
| ~ | ~ |
| 10 | A large amount of resonance will be applied to the selected sound. |

Damper Noise

| Value | Description |
|-------|---|
| Off | Damper Noise will not be applied to the selected sound. |
| 1 | A small amount of Damper Noise will be applied to the selected sound. |
| ~ | ~ |
| 10 | A large amount of Damper Noise will be applied to the selected sound. |

Undamped String Resonance

| Value | Description |
|-------|--|
| Off | Undamped String Resonance will not be applied to the selected sound. |
| 1 | A small amount of Undamped String Resonance will be applied to the selected sound. |
| ~ | ~ |
| 10 | A large amount of Undamped String Resonance will be applied to the selected sound. |

MEMO

The dampers of an acoustic piano span almost the full width of the keyboard. However, the topmost 18 keys (shown in the following illustration) do not incorporate dampers, as the shorter strings for these treble notes decay quickly and therefore do not need to be dampened.



Cabinet Resonance

| Value | Description |
|-------|--|
| Off | Cabinet Resonance will not be applied to the selected sound. |
| 1 | A small amount of Cabinet Resonance will be applied to the selected sound. |
| ~ | ~ |
| 10 | A large amount of Cabinet Resonance will be applied to the selected sound. |

Key-off Effect

| Value | Description |
|-------|---|
| Off | Key-off Effect will not be applied to the selected sound. |
| 1 | A small amount of Key-off Effect will be applied to the selected sound. |
| ~ | ~ |
| 10 | A large amount of Key-off Effect will be applied to the selected sound. |

Fall-Back Noise

| Value | Description |
|-------|--|
| Off | Fall-Back Noise will not be applied to the selected sound. |
| 1 | A small amount of Fall-Back Noise will be applied to the selected sound. |
| ~ | ~ |
| 10 | A large amount of Fall-Back Noise will be applied to the selected sound. |

Hammer Noise

| Value | Description |
|-------|---|
| Off | Hammer Noise will not be applied to the selected sound. |
| 1 | A small amount of Hammer Noise will be applied to the selected sound. |
| ~ | ~ |
| 10 | A large amount of Hammer Noise will be applied to the selected sound. |

Hammer Delay

| Value | Description |
|-------|---|
| Off | Hammer Delay will not be applied to the selected sound. |
| 1 | A small amount of Hammer Delay will be applied to the production of the selected sound. |
| ~ | ~ |
| 10 | A large amount of Hammer Delay will be applied to the production of the selected sound. |

Topboard

| Type | Description |
|---------|---|
| Open3 | Simulates the character of a fully open topboard, with maximum sound projection. |
| Open2 | Simulates the character of a half open topboard, with reduced sound projection. |
| Open1 | Simulates the character of a partially open topboard, with limited sound projection. |
| Closed1 | Simulates the character of a closed rear topboard, but open front topboard, with limited sound projection. |
| Closed2 | Simulates the character of a closed rear topboard and closed front topboard, with minimum sound projection. |

Decay Time

| Value | Description |
|-------|--------------------------------|
| 1 | Held notes will decay quickly. |
| ~ | ~ |
| 10 | Held notes will decay slowly. |

Release Time

| Value | Description |
|-------|------------------------------------|
| 1 | Released notes will decay quickly. |
| ~ | ~ |
| 10 | Released notes will decay slowly. |

Minimum Touch

| Value | Description |
|-------|--|
| 1 | A very gentle key press will produce a very soft sound. |
| ~ | ~ |
| 20 | A stronger key press will be required in order to produce a sound. |

Stretch Tuning

| Type | Description |
|--------|---|
| Off | Stretch tuning is disabled. |
| Normal | Normal stretch tuning is applied, with a lower low end and a higher high end. |
| Wide | Wide stretch tuning is applied, with a lower low end and a higher high end than Normal. |
| User | A custom tuning method, allowing the pitch of each key to be individual tuned. |

 **CHECK**

Stretch Tuning is displayed only when the temperament of the instrument is an equal temperament.

User Tuning

1. Tap [Edit] in the User Tuning area to display the Tuning Editor screen.
2. Tap the [-] and [+] buttons in the Key area to select the desired note to be adjusted, or to select a note directly, press the desired key on the instrument's keyboard.

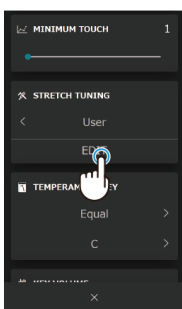

3. Tap the [-] and [+] buttons in the Tuning area to adjust the value for the selected note, or drag the graph to adjust the tuning. The Tuning value can be adjusted within the range of -50~+50 cents.

Tap the [Reset] button to return to the default settings.

Tap  to return to the detailed settings screen.

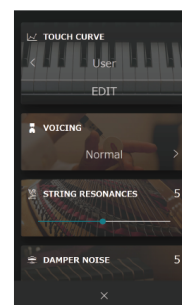
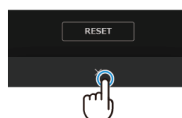

Temperament

| Type | Description |
|--|---|
| Equal Temperament (Equal) | This temperament is the most popular tuning method, and divides the scale into twelve equal semi-tones. This produces the same chordal intervals in all twelve keys, and has the advantage of limitless modulation of the key. |
| Pure Temperament (Pure Major/Pure Minor) | This temperament, which eliminates dissonances for thirds and fifths, is still popular in choral music because of its perfect harmony. Any key modulation will result in dissonances. |
| Pythagorean Temperament (Pythagorean) | This temperament, which uses mathematical ratios to eliminate dissonance for fifths, is very limited for use with chords, but produces very characteristic melodic lines. |
| Meantone Temperament (Meantone) | This temperament, which uses a mean between a major and minor whole tone to eliminate dissonance for thirds, was devised to eliminate the lack of consonances experienced with certain fifths for the Mersenne pure temperament, producing a sound that was widely used in instruments of previous periods. |
| Werckmeister Temperament (Werckmeister) | These two temperaments are placed in between Meantone and Pythagorean. For music with few accidentals, this temperament produces the beautiful chords of the mean tone, but as accidentals increase, the temperament produces the characteristic melodies of the Pythagorean temperament. It is used primarily for classical music written in the Baroque era to revive the original characteristics. |
| User Temperament (User) | A custom temperament, created by raising or lowering the pitch of each note in the scale. |

Temperament Key

When using a temperament other than Equal temperament, use this setting to specify the key signature of the piece.

User Temperament

1. Tap [Edit] in the User Temperament area to display the Temperament Editor screen.

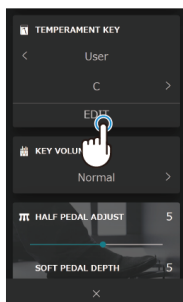

2. Tap the [-] and [+] buttons in the Key area to select the desired note to be adjusted, or to select a note directly, press the desired key on the instrument's keyboard. Tap the [-] and [+] buttons in the Temperament area to adjust the value for the selected note, or drag the graph to adjust the temperament. The User Temperament value can be adjusted within the range of -50~+50 cents. The current Temperament Key setting is shown by a  symbol above the defined key.



Tap the [Reset] button to return to the default settings.



Tap  to return to the detailed settings screen.

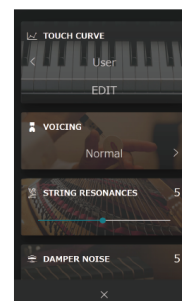
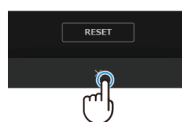

Key Volume

| Type | Description |
|--------------------|--|
| Normal | An evenly balanced volume throughout the keyboard. |
| High Damping | Gradually reduces the volume of the keyboard towards the treble region. |
| Low Damping | Gradually reduces the volume of the keyboard towards the bass region. |
| High & Low Damping | Gradually reduces the volume of the keyboard in both the treble and bass regions. |
| Center Damping | Gradually reduces the volume of the keyboard in the central region. |
| User | A custom keyboard volume, allowing the volume of each key to be individually adjusted. |

User Key Volume

1. Tap [Edit] in the Key Volume area to display the Key Volume Editor screen.

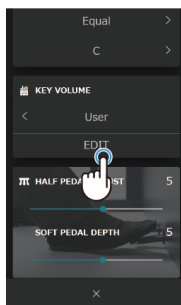

2. Tap the [-] and [+] buttons in the Key area to select the desired note to be adjusted, or to select a note directly, press the desired key on the instrument's keyboard.

Tap the [-] and [+] buttons in the Volume area to adjust the value for the selected note, or drag the graph to adjust the volume. The volume value can be adjusted within the range of -50~+50 cents.

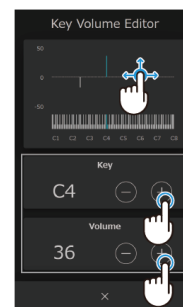

Tap the [Reset] button to return to the default settings.



Tap the [X] button to return to the detailed settings screen.

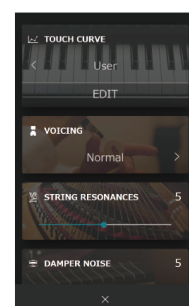
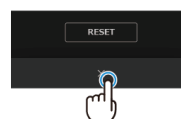

Half-Pedal Adjust

| Value | Description |
|-------|--|
| 1 | This setting allows the half-pedal to start at the earliest point. |
| ~ | ~ |
| 7 | This setting allows the half-pedal to start at the latest point. |
| 8 | This setting is intended for using the pedal as a MIDI controller. The maximum value can be reached easily, without pressing the damper pedal fully. |
| ~ | ~ |
| 10 | This setting is intended for using the pedal as a MIDI controller. The maximum value will be reached when the damper pedal is pressed fully. |

Soft Pedal Depth

| Value | Description |
|-------|---|
| 1 | The soft pedal will have a relatively small softening effect on the selected sound. |
| ~ | ~ |
| 10 | The soft pedal will have a relatively large softening effect on the selected sound. |

Other Sound Settings (Sound tab only)

When a sound other than a piano is selected, the sound can be edited by tapping the [Edit] button. The settings are the same as the VPA settings.

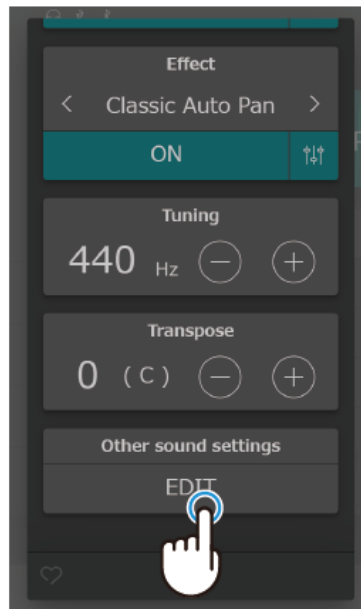

CHECK

The items that can be adjusted differ depending on the sound.

Damper Hold (Other Sound Settings only)

| Type | Description |
|------|---|
| On | Organ, strings, etc. sounds will be sustained continuously while the damper pedal is pressed, even after the keys have been released. |
| Off | Organ, strings, etc. sounds will gradually decay after the keys are released while the damper pedal is pressed. |

Player Detailed Functions

The player can play the following types of files.

- Songs built into the instrument
- Songs that were recorded and saved on the instrument
- SMF files (format 0, format 1) on a USB memory device
- mp3 files on a USB memory device (bitrate: 8k to 320bps, sampling rate: 44.1 kHz/48 kHz/32 kHz, stereo)
- Wav files on a USB memory device (sampling rate: 44.1 kHz, 16-bit, stereo)
- Sound Demo is not supported in Concert Magic or Lesson mode.

Accessing the Player Screen

Tap the Mini Player area on the [Music tab screen](#) to access the Player screen.

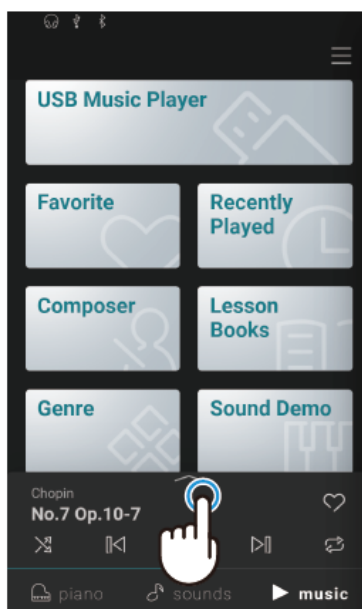

CHECK

The Mini Player is displayed when a song is selected.

Player Screen

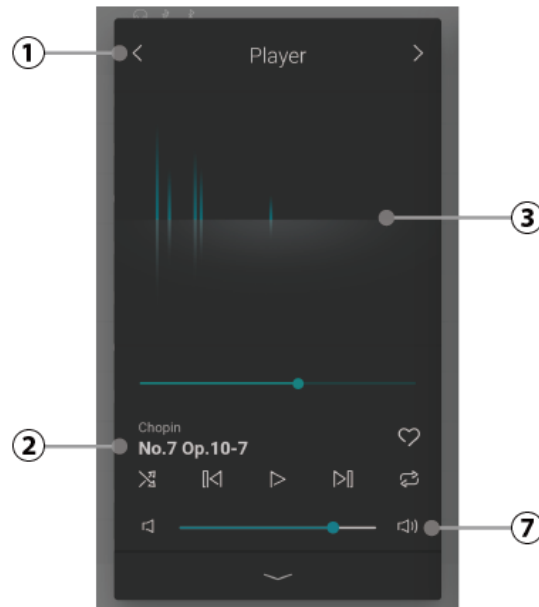

① Player mode

Operation:

Built-in songs can be played using any of three functions: Player, Lesson, or Concert Magic.

② Song/piece information

This area indicates the title and composer of the current song/piece.

③ Animation

This area displays an animation that matches the rhythm of the current song/piece.

④ Playing position

Operation:

This area displays the playing position of the current song/piece. Drag the slider  right/left to change the current playing position.

⑤ Volume

Operation:

This area allows adjustment of the playback volume of the current song/piece.



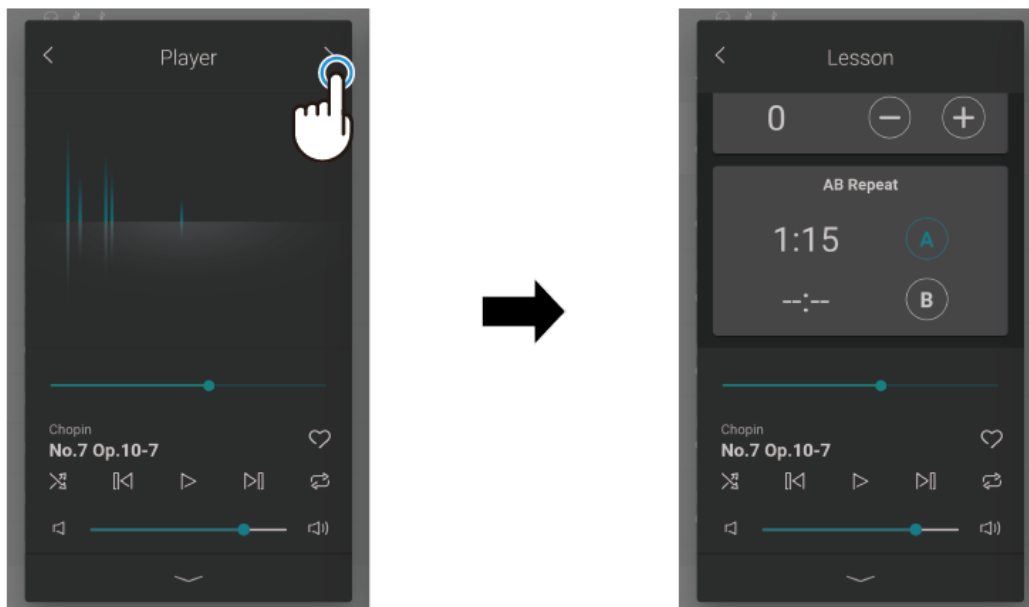

Lesson

Accessing the Lesson Screen

Tap the  button for Player mode on the Player screen to access the Lesson screen.



Lesson functions

| Function | Description | Operation |
|--------------------|--|---|
| Tempo | Adjust the playback tempo of the current song/piece. |  |
| Metronome Volume | Adjust the volume of the Metronome. |  |
| Left/Right Balance | Adjust the volume balance between the Left/Right hand parts of the current song/piece. This setting is used to adjust the volume balance between the Main (right section) and Sub (left section) sounds. |  |
| Transpose | Adjust the playback pitch of the currently song/piece in semi-tone steps. |  |
| AB Repeat | Repeat a passage of the song/piece continuously. |  |

Tempo

Drag the "Tempo"  slider right/left to adjust the tempo.

Drag the slider  to the right to increase the tempo, and to the left to decrease the tempo.



Metronome Volume

Drag the "Metronome Volume" slider  right/left to adjust the metronome volume.

Drag the slider  to the right to increase the volume, and to the left to decrease the volume.

Left/Right Balance

Drag the "Left/Right Balance"  slider left/right to adjust the volume balance between the left-hand and right-hand parts.

- **When practicing the right-hand part while playing the left-hand part on the player**
Drag the slider  to the left to reduce the volume of the right-hand part.
- **When practicing the left-hand part while playing the right-hand part on the player**
Drag the slider  to the right to reduce the volume of the left-hand part.

Transpose

Tap the [+] [-] buttons to change the key.

The key can be changed in semi-tone steps in a range from -12 to 12.

AB Repeat

Passages of a song/piece can be repeated continuously by specifying the start and end points.

1. While the desired song/piece is playing, tap the [A] button to specify the start point of the passage to be repeated.
2. Tap the [B] button to specify the end point of the passage to be repeated. The specified passage will be played repeatedly.

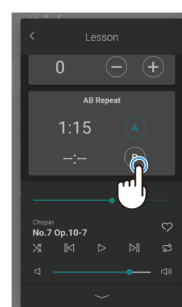
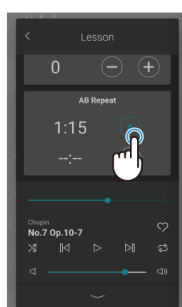

3. Tap either the [A] or [B] buttons to turn off the repeat function and restore the normal playback method.

Concert Magic

The Concert Magic function allows complete beginners to enjoy playing the piano by simply tapping the keyboard with a steady rhythm and tempo.

Accessing the Concert Magic Screen

Tap the  button for Player mode on the Player screen to access the Concert Magic screen.

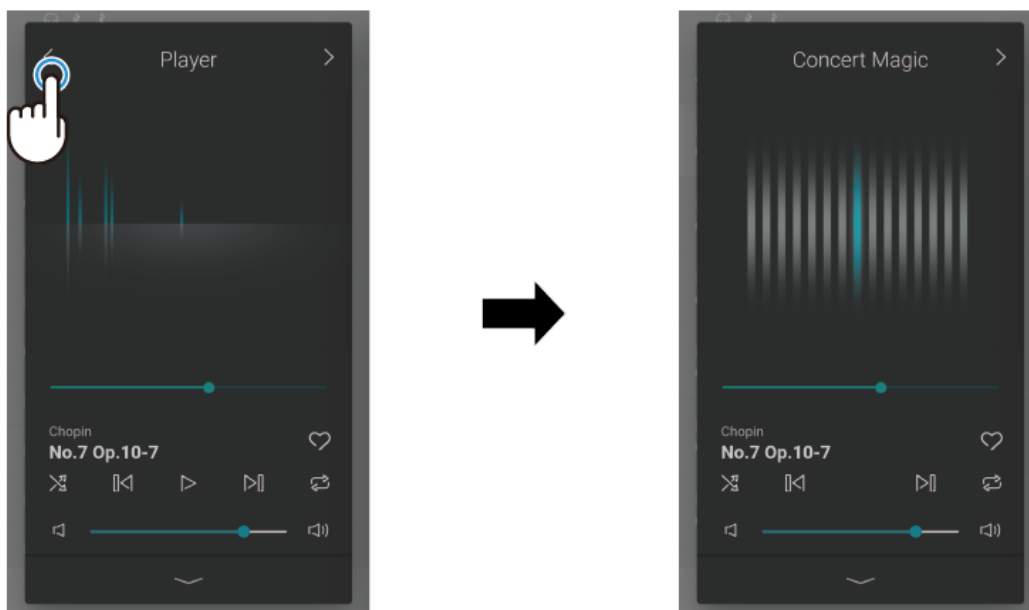

Performing

With a song/piece selected, play the keyboard with the appropriate rhythm to proceed with the performance.

- The speed of the song/piece is determined by the intervals at which the rhythm is played.
- Pressing the keys gently will produce a soft sound, while pressing heavily will produce a loud sound.
- An animation will be displayed as the song/piece is performed as a guideline for the timing for playing the keyboard.

CHECK

It is also possible to perform by tapping on the animation on the Concert Magic screen. Tapping on the upper part of the screen produces a loud sound, while tapping on the bottom part of the screen produces a soft sound, and adds a dynamic quality to the performance.

Recorder Detailed Functions

Recorder screen

This screen is dedicated to the Recorder. Recording time can be checked, and overdubbing and various Recorder functions can be used on this screen.

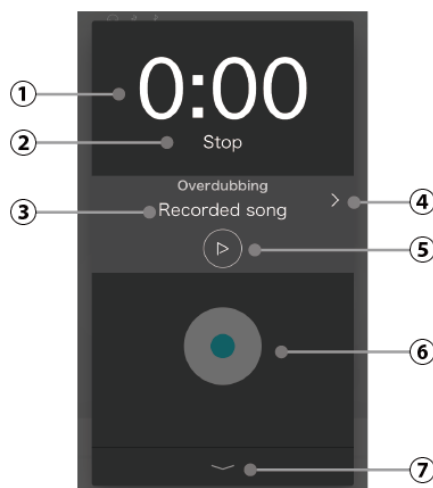

① Recording time

This area indicates the recording time.

② Recording status

This area indicates the Recorder status (Standby, Recording...).

③ Overdubbing song title

This area indicates the title of the song selected for overdubbing.

④ Song selection button

Operation: 

This button is used to display the song selection screen for overdubbing. This button will be hidden during recording.

⑤ Playback button

Operation: 

This button is used to play the song that has been selected for overdubbing. This button will be hidden during recording.

⑥ Record button

Operation: 

 (Normal): The Recorder is not in use.

 (Standby): The Recorder is in standby, and will start with the next key press.

 (Recording): The Recorder is recording.

⑦ Close button

Operation: 

This button closes the Recorder screen, and displays the Piano tab or the Sound tab. The recording status continues to be displayed on the Mini Recorder.

Overdubbing

Method 1

1. Record a performance in the normal way, then tap the [Overdub] button on the Recording completed screen.

The Recording start screen will appear.

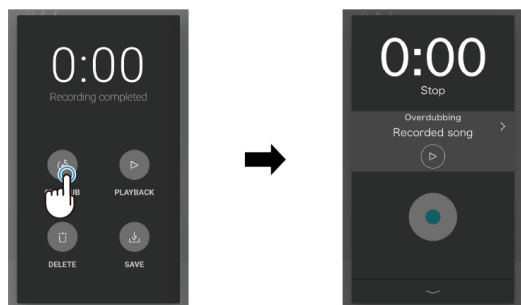

2. Tap  to enter the Standby state.

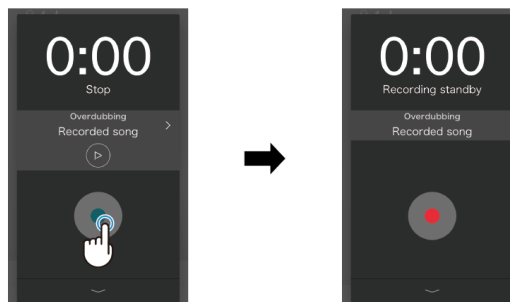

3. Tap  again to start recording, or begin playing to start recording automatically.

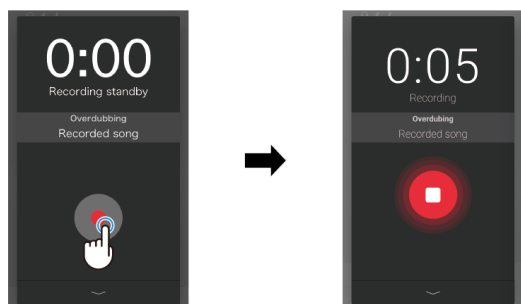

4. Tap  to stop recording.

When recording stops, the Recording completed screen will appear.

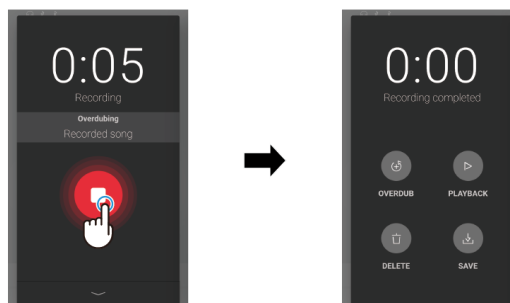

5. Tap the [Playback] button to playback the recorded performance. Tap the [Save] button to save the recorded performance, or the [Delete] button to delete it.

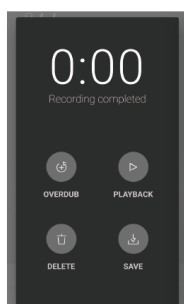

Method 2

1. Double tap .

The Recording start screen will appear.

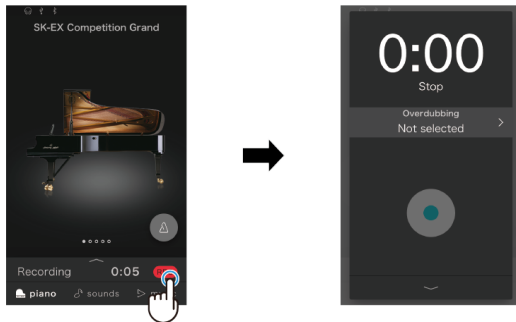

2. Tap the Select button to access the Song selection screen.

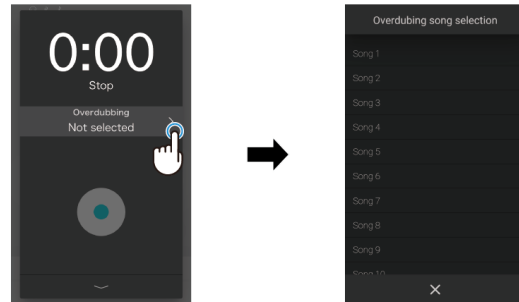

3. Tap the song to be overdubbed to.

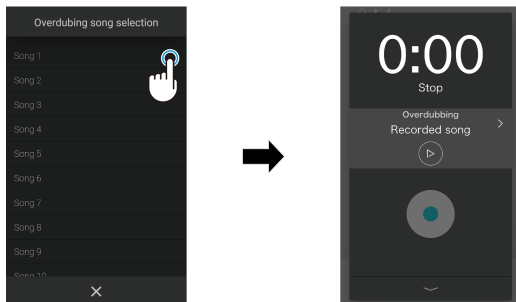

Subsequent operations are the same as operations 2 to 5 in Method 1.

CHECK

When overdubbing a performance recorded to the instrument's internal memory, overdubbing can only be used once. In order to use multiple overdubs, please select the WAV (or MP3) audio recorder format to enable recording to USB memory.

 **P.90** USB Memory Recorder Settings

Menu

The Menu contains a variety of options to adjust the digital piano's operation and sound. These settings are grouped by category, providing convenient access to relevant controls. Tap  to access the Menu screen.

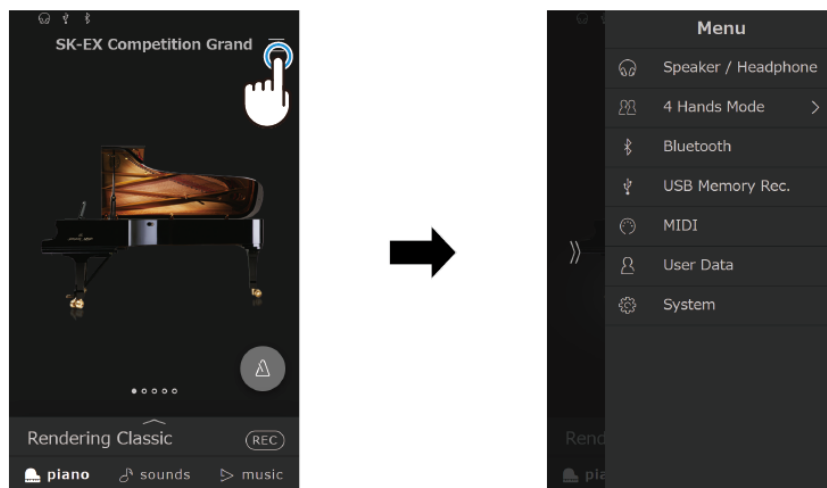

Menu Item List

| Item | Description |
|---------------------|--|
| Speaker / Headphone | This item contains settings to adjust the sound heard through the instrument's speakers or connected headphones. |
| 4 Hands Mode | This item is used to enable and adjust the 4Hands Mode function. This function divides the keyboard into two sections with the same key range. Furthermore, the damper (right) pedal and soft (left) pedal act as separate damper pedals for the respective right and left sections, allowing two people to perform piano duets using a single instrument. |
| Bluetooth | This item contains settings to adjust the instrument's Bluetooth MIDI and Audio functions. |
| USB Memory Recorder | This item contains functions related to using a USB memory device with the instrument. |
| MIDI | This item contains various functions and settings related to MIDI. |
| User Data | This item contains functions to reset various User data, and also to perform a Factory Reset. |
| System | This item contains functions and settings to adjust the LCD touchscreen appearance, and the instrument's start-up behavior, etc. |

Speaker/Headphone settings

Accessing Speaker/Headphone settings

Tap the "Speaker/Headphone" menu item to enter the Speaker Headphone settings.

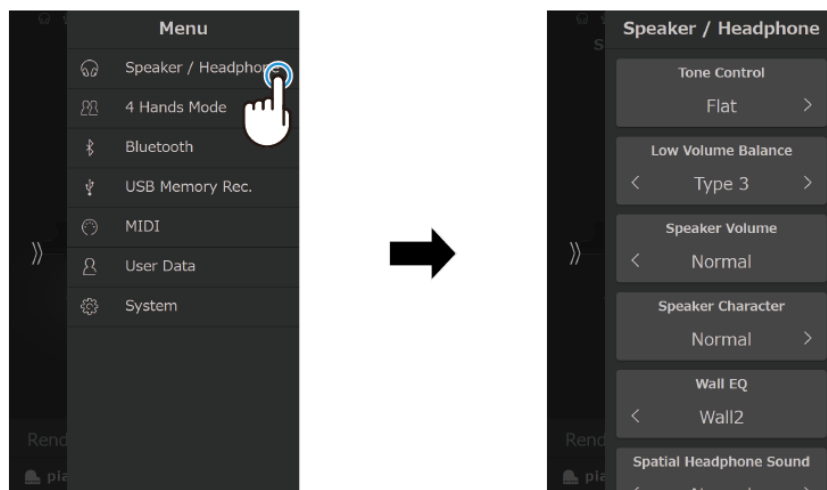





Speaker/Headphone settings

| Type | Description | Operation |
|-------------------------|--|-----------|
| Tone Control | The Tone Control setting allows the overall sound character of the digital piano to be adjusted to provide the best sound quality within the area that the instrument is located. | |
| Low Volume Balance | The Low Volume Balance setting reduces the difference in volume between pianissimo and fortissimo touches, allowing the piano to continue to be played at low volume without the sound of pianissimo notes being lost. | |
| Speaker Volume | The Speaker Volume setting allows the maximum volume level of the digital piano's speaker output to be reduced, providing finer adjustment control over the master volume. | |
| Speaker Character | The Speaker Character setting allows the character of the instrument's speakers to be adjusted. | |
| Wall EQ | The Wall EQ setting adjusts the character of the digital piano's speaker system in order to achieve optimum sound when the rear of the instrument is placed in front of a wall. (CA901 only) | |
| Spatial Headphone Sound | Spatial Headphone Sound is a special feature of the digital piano that enhances the depth and realism of the acoustic piano sound when listening through headphones or earphones. | |
| Headphone Type | The Headphone Type setting optimises the sound of the digital piano when listening through different types of headphones or earphones. | |
| Headphone Volume | The Headphone Volume setting allows the maximum volume level of the headphones output to be increased. The "High" setting may be selected when using headphones with a high impedance, or in situations where it is desirable to increase the maximum volume level of the headphones output. | |

Tone Control

| Type | Description |
|------------|--|
| Flat | Tone control adjustment is not applied. |
| Brilliance | Adjusts the overall brightness of the sound. |
| Bass Boost | Emphasises low-range frequencies, creating a deeper sound. |
| Bass Cut | Reduces low-range frequencies, creating a clearer sound. |
| Mid Boost | Emphasises mid-range frequencies, creating a harder sound. |
| Loudness | Emphasises frequencies to retain the digital piano's sound character when playing at low volume levels. |
| Bright | Emphasises high-range frequencies, creating a brighter sound. |
| Mellow | Reduces high-range frequencies, creating a softer sound. |
| User | Allows the Low (20-100Hz), Mid-low (200-8000Hz), Mid-high, and High range (5000-20000Hz) frequency bands to be adjusted separately. The frequency for Mid-low and Mid-high can also be selected. |

Brilliance Settings

Tap the   buttons in Tone Control, and select Brilliance to display the slider . Drag the slider  to adjust the Brilliance.

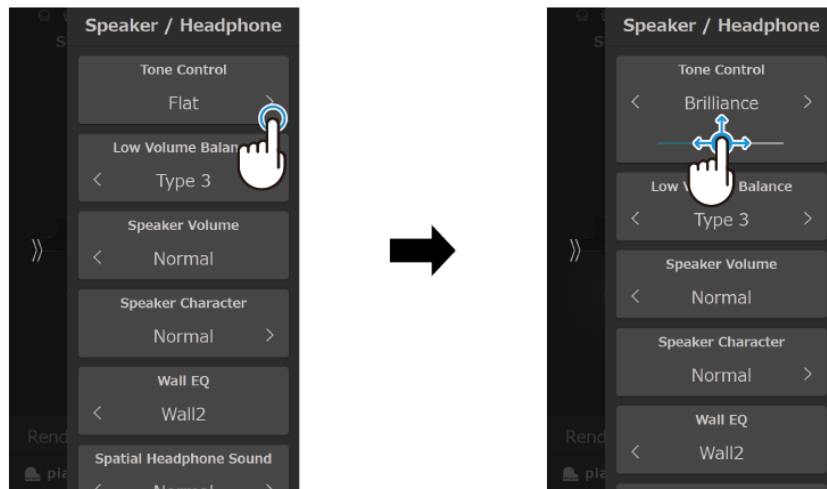

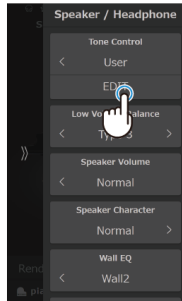

User Tone Control

1. Tap [Edit] in "User Tone Control" to access the Tone Control Editor screen.

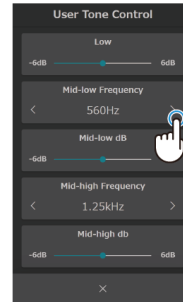

2. Tap the < > buttons to select the desired frequency range.



3. Tap  to return to the Speaker/Headphone settings

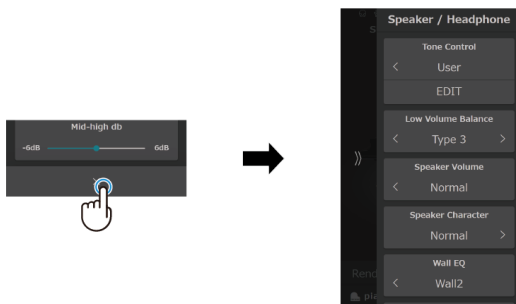

Low Volume Balance

| Type | Description |
|--------|--|
| Off | Low Volume Balance adjustment is not applied. |
| Type 1 | When the Master Volume is set to a low level, a small amount of Low Volume Balance adjustment will be applied. |
| ⋮ | ⋮ |
| Type 5 | When the Master Volume is set to a low level, a large amount of Low Volume Balance adjustment will be applied. |

Speaker Character

| Type | Description |
|--------|---|
| Normal | The instrument's speakers will produce sound with a normal tonal character. |
| Smooth | The instrument's speakers will produce sound with a smooth tonal character. |

CHECK

This setting does not affect the headphone or Line Out output.

Speaker Volume

| Type | Description |
|--------|---|
| Normal | The instrument's speakers will output sound at the normal volume level. |
| Low | The instrument's speakers will output sound at a reduced volume level. |

CHECK

This setting does not affect the headphone or Line Out output.

Wall EQ

| Type | Description |
|--------|---|
| Off | Optimise the speaker system for placing the digital piano in an area away from a wall. |
| Wall 1 | Optimise the speaker for placing the digital piano in front of a heavy wall such as brick/concrete. |
| Wall 2 | Optimise the speaker for placing the digital piano in front of a light wall such as plasterboard. |

CHECK

This setting does not affect the headphone or Line Out output.

Spatial Headphone Sound

| Type | Description |
|---------|--|
| Off | Disable the Spatial Headphone Sound feature. |
| Forward | Front focused, somewhat narrow spatial positioning. |
| Normal | Naturally balanced spatial positioning that is neither forward nor wide. |
| Wide | Wide, very open spatial positioning. |

CHECK

This setting does not affect the speaker or Line Out output.

Phones Type

| Type | Description |
|-----------|--|
| Normal | Disables headphone optimisation. |
| Open | Optimises the sound for open type headphones. |
| Semi-Open | Optimises the sound for semi-open type headphones. |
| Closed | Optimises the sound for closed type headphones. |
| Inner-ear | Optimises the sound for inner-ear type headphones. |
| Canal | Optimises the sound for canal-type headphones. |

CHECK

This setting does not affect the speaker or Line Out output.

Headphone Volume

| Type | Description |
|--------|---|
| Normal | The instrument's headphone connectors will output sound at the normal volume level. |
| High | The instrument's headphone connectors will output sound at an increased volume level. |

CHECK

This setting does not affect the speaker or Line Out output.



4 Hands Mode settings

1. Tap "4 Hands Mode" menu item to enable 4 Hands Mode.

The keyboard will be divided into right and left sections.

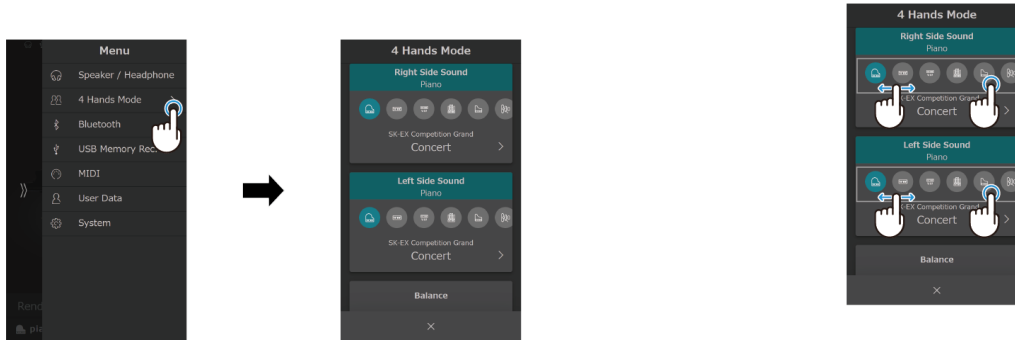
2. Swipe the icons left/right to scroll through the available instrument types, then tap to select the desired icons for the right side and the left side.



3. Tap the   buttons to change the sound in the instrument category for the right section and the left section.

4. Tap the  button to close the 4 Hands Mode window and return to the Normal playing mode.

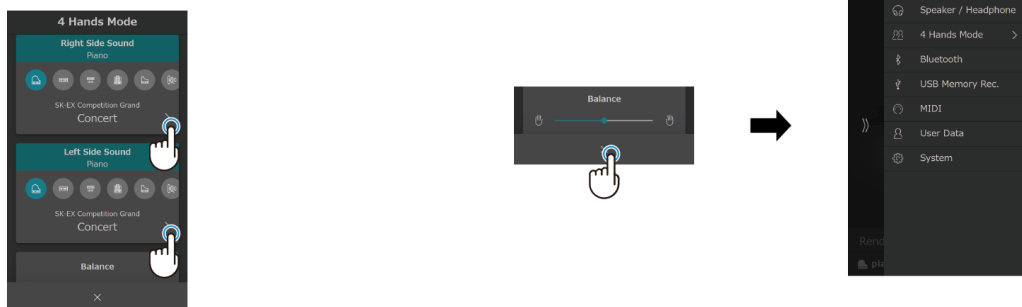

4 Hands Mode Detailed Settings

The following settings can be changed in 4 Hands Mode.

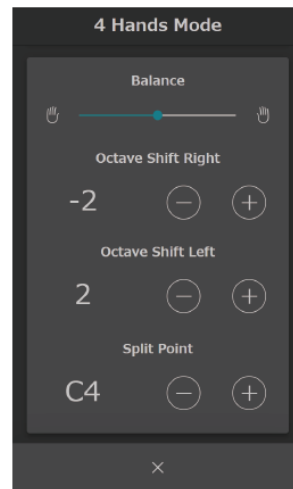

Balance

This setting is used to adjust the balance between the volume of the left section and the right section. Drag the Balance slider left/right to increase the volume of the left/right section.

Octave Shift

This setting is used to lower/raise the pitch of the Right and Left section sounds in octave steps. Tap the [-] and [+] buttons to change the Octave Shift value for each section.

The Octave Shift value can be adjusted within the range of 0~+3 for the left section and -3~0 for the right section.

Split Point

This setting is used to set the point on the keyboard that divides the right section and the left section.

Tap the [-] and [+] buttons to change the Split Point.

Bluetooth settings

Accessing Bluetooth settings

Tap the "Bluetooth" menu item to enter the Bluetooth settings.

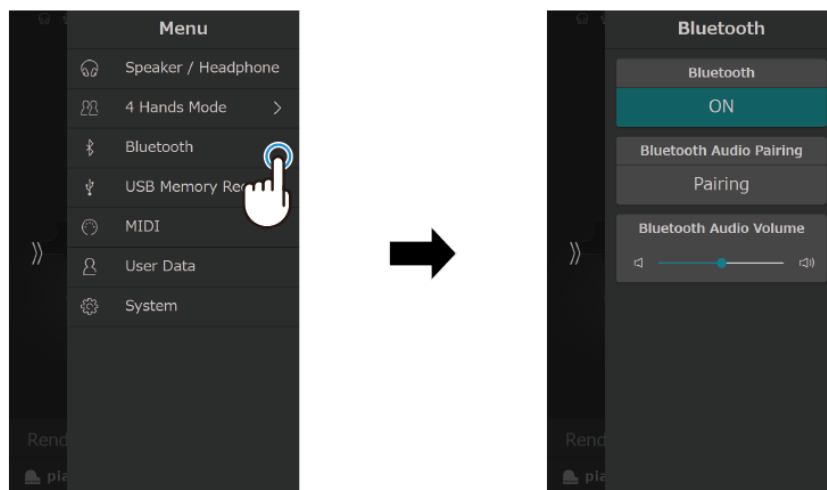

Bluetooth types and connection methods

| Type | Description | Connection method |
|-----------------|---|--|
| Bluetooth MIDI | When using a smart device app that supports Bluetooth MIDI, this function allows the instrument to be controlled by an app, or send/receive MIDI data wirelessly. | Enable the smart device's Bluetooth function, launch an app that supports Bluetooth MIDI, then select "CA901 MIDI" or "CA701 MIDI" from the app's connection setting screen. |
| Bluetooth Audio | This function allows audio from the connected smart device (such as songs, videos, etc.) to be played through the instrument's speakers wirelessly. | Enable the smart device's Bluetooth function, then select "CA901 Audio" or "CA701 Audio" from the device's Bluetooth connection setting screen. After pairing successfully, the instrument will automatically reconnect to the smart device when the power is turned on. |

CHECK

- For more detailed instructions regarding Bluetooth connectivity, please refer to the supplementary Bluetooth Connectivity Guides, available from the Kawai Global website: https://www.kawai.jp/product/c/application/dp_application/
- For each Bluetooth MIDI and Bluetooth Audio function, only one smart device can be connected at the same time.
- The digital piano does not support transmitting audio using Bluetooth Audio. Therefore, it is not possible to connect speakers or headphones to the instrument via Bluetooth. Availability of Bluetooth MIDI and Bluetooth Audio functions dependent on market location.

Bluetooth On / Off

This setting turns the digital piano's Bluetooth MIDI and Bluetooth Audio functions on and off.

Bluetooth Audio pairing

If "CA901 Audio" or "CA701 Audio" does not appear as a pairing option on the smart device, tap the Pairing button to reset the current Bluetooth Audio connection and place the instrument in Pairing mode.

Bluetooth Audio Volume

This setting is used to increase or decrease the volume level of Bluetooth Audio playback. While it's generally preferable to adjust the audio volume level on the smart device itself, this setting may still be useful in certain situations.
Drag the slider  right/left to increase/decrease the Bluetooth Audio Volume setting.

USB Memory Recorder Settings

Information about USB memory devices

Connect the USB memory device to the [USB TO DEVICE] port located on the front of the digital piano. The USB memory device should be connected directly to the instrument, and not via an extension cable or any other auxiliary devices. This digital piano's [USB TO DEVICE] port is USB2.0 compliant, and is intended for connecting storage media.

Disconnecting USB memory devices

When disconnecting the USB memory device, ensure that the device is not being accessed in order to prevent data loss.

CHECK

If a USB memory device is connected while the digital piano is starting up, the instrument may take additional time before producing a sound.

Checking the USB Memory connection status

When a USB memory device is connected to the digital piano's [USB TO DEVICE] port, a USB icon will be displayed in the status bar or the LCD touchscreen display.

Accessing USB Memory Recorder

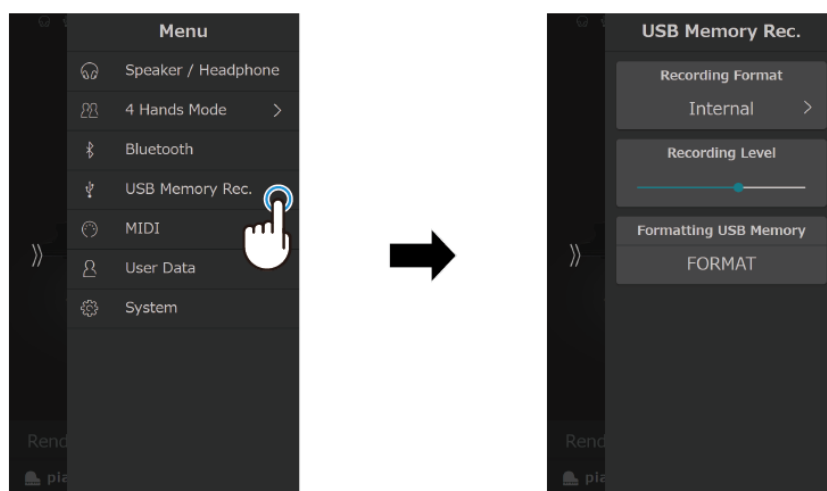

Tap the "USB Memory Rec." menu item to enter the USB Memory Recorder settings.



✓ CHECK

- Be careful when formatting, as data that is not displayed on the digital piano may be stored in the USB Memory device specified by other devices.
- The "USB Memory Rec." menu item is only displayed when a USB memory device is connected to the [USB TO DEVICE] port.

Recording Format

Tap the   buttons to select a Recording format.

- Internal format
Internal format songs are stored in the instrument's internal memory and cannot be saved to a USB memory device.
The digital piano's memory can store a maximum of 10 songs.
- mp3 format
The recording will be saved to the connected USB memory device in MP3 format.
The recording will be saved to the connected USB Bit rate: 256 kbps (CBR), Sampling Frequency: 44.1 kHz, Stereo
- wav format
The recording will be saved to the connected USB memory device in WAV format.
Sampling Frequency: 44.1 kHz, 16-bit, Stereo

Recording Level

When the Recording Format setting is set to WAV or MP3, the Recording Level setting allows the recording level (gain) to be adjusted. Drag the slider  right/left to adjust the recording level.

✓ CHECK

- Dragging the slider to the right increases the Recording Level, allowing quiet sounds such as pianissimo playing to become recorded clearly, however this may cause loud sounds such as fortissimo playing to be clipped (distorted).
- Dragging the slider to the left reduces the Recording Level, allowing loud sounds such as fortissimo playing to be recorded without clipping, however this may make it difficult to record quiet sounds such as pianissimo playing.

USB Memory Format

The contents of the USB memory device can be formatted before being used with the digital piano. If a message prompting the user to perform a format operation appears when connecting a USB memory device to the [USB TO DEVICE] port, make sure that important data is not stored on the device. Formatting will erase the contents of the USB memory device.

User Data Settings











User Data

| Item | Description |
|--------------------------|--|
| Favorite (Sounds) | All of the sounds registered in the "Favorite" category of the Sounds tab can be reset (removed). |
| Recently Played (Sounds) | All of the sounds registered in the "Recently Played" category of the Sounds tab can be reset (removed). |
| User | User sounds can be reset (removed). |
| Favorite (Music) | All of the songs/pieces registered in the "Favorite" category of the Music tab can be reset (removed). |
| Recently Played (Music) | All of the songs/pieces registered in the "Recently Played" category of the Music tab can be reset (removed). |
| Recorder | All of the songs/pieces registered in the "Recorder" category of the Music tab can be reset (removed). |
| Reset to Default | All data saved on the digital piano can be removed to return the digital piano to the default state from the time of purchase. |

System Settings

System menu item contains functions and settings to adjust the LCD touchscreen appearance, and the instrument's start-up behavior etc.

System

| Item | Description | Operation |
|------------------|--|---|
| LCD Brightness | The LCD Brightness setting is used to adjust the brightness of the digital piano's touchscreen display. Drag the  slider right/left to increase/decrease the LCD brightness. |  |
| Display Scale | The Display Scale setting is used to adjust the size of the text and interface used by the digital piano's touchscreen display. Drag the  slider right/left to increase/decrease the size of the text and interface. |  |
| Auto Display Off | The Auto Display Off setting determines whether or not the digital piano's touchscreen display will turn off automatically after a period of inactivity. This setting may be desirable if the display becomes a distraction when playing in low-light environments. |  |
| Auto Power Off | The Auto Power Off setting can be used to automatically turn off the digital piano after a specified period of inactivity. This function may be enabled by default, depending on the market location. |  |
| Startup Screen | The Startup Screen setting determines which screen will be shown when the digital piano initially starts-up. |  |
| Startup Settings | The Startup Settings setting determines which settings will be used when the digital piano starts-up. |  |
| Language | The Language setting determines which language will be used for the digital piano's LCD display user interface. |  |
| Information | The Information function displays details about the digital piano's software version, and license information. |  |

✓ CHECK

- To use an edited sound as a startup setting, first save the edited sound as a User sound.

P.54 Saving User sounds

- The "Startup Screen" setting is given priority over the the "Startup Settings" setting.

Example

Setting an edited "Tine Electric Piano" as a User sound." as a startup setting

1. Save the edited "Tine Electric Piano".



2. With the edited "Tine Electric Piano" Sound1 in this case selected, set the "Startup Screen" setting to "Sounds", and the "Startup Settings" setting to "Current".

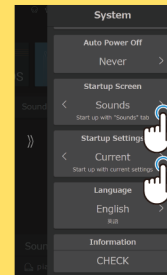

Troubleshooting

Power

The power does not turn on

Check that the power cable is correctly connected on both the outlet side and the instrument side. It may be connected on one end, and disconnected on the other. Try disconnecting and then reconnecting the power cable.

P.15 1. Connecting the power cable to the instrument

The power suddenly turns off, or turns off after a period of inactivity

Check that the "Auto Power Off" function is not enabled.

The screen suddenly turns off

If the time for the display to turn off has been set in "Auto Display Off", the display will automatically turn off when the set time has elapsed. Tap the display to turn it on again.

Sound

This digital piano attempts to reproduce the rich variety of tones created by an acoustic grand piano as accurately as possible. This includes various resonances, noises, and other subtle characteristics that contribute to the overall piano playing experience. While these additional tones are intended to enhance the realism of the instrument, it is possible to reduce their prominence, or disable the effects altogether using the VPA advanced settings menu.

No sound is produced

- Check that the volume is not set to the lowest position.
- Check that a pair of headphones (or headphone adaptor plug) is not connected to the PHONES jack.
- Check that Local Control is enabled in the MIDI Settings menu.

P.16 Volume and Headphones

The sound distorts when performing certain pieces or in certain registers

If the volume is increased, the sound may be distorted when performance certain pieces. In this case, turn down the volume before playing the instrument.

The volume differs depending on the key pressed

Adjust the volume of the problematic key using the Key Volume parameter in the VPA advanced settings menu.

The pitch of certain keys sounds incorrect

Adjust the pitch of the problematic key using the User Tuning parameter in the VPA advanced settings menu.

There is noise or a metallic sound

Adjust the sound using the Tone Control setting, or the Fall-Back Noise or Damper Noise parameters in the VPA advanced settings menu.

The sound seems muffled/the sound is shrill

Adjust the sound using the Tone Control setting, or the Topboard, Touch Curve, or Voicing parameters in the VPA advanced settings menu.

The sustain pedal is not depressed but the sound in the topmost 18 notes of the keyboard are still sustained

This is not abnormal. On an acoustic grand piano, the keys in the higher register of the keyboard do not have dampers attached to stop the strings vibrating. This digital piano faithfully reproduces this characteristic, allowing the sound of the topmost keys of the keyboard to be sustained without the damper pedal pressed.

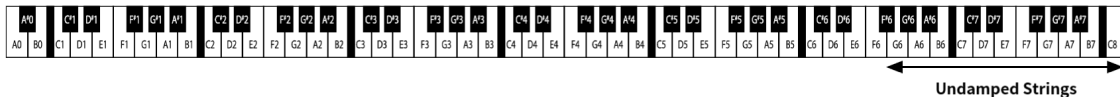

Pedals

The pedals make a noise when they are depressed

When the sustain pedal is depressed, you will hear the sound of the strings that occurs when the damper is released even if the keyboard is not being played. This is not a malfunction.

The pedals are ineffective

Check that the pedal cable is correctly connected to the instrument. Even if it is connected, disconnect the pedal cable and then securely reconnect it.

When depressing a pedal, the pedal board flexes and is not firm

Check that the pedal support bolt is fully extended.

Connectivity

The instrument cannot connect to the smart device/app via Bluetooth

- Check that the instrument's Bluetooth function is turned on.
- Bluetooth MIDI should be connected from the settings in the app, not from the Bluetooth settings of the smart device.

Cannot connect to a connected smart device

If the connection is immediately disconnected, turn the Bluetooth settings off and then on again, and retry the connection.

The name of the instrument does not appear on the smart device

The instrument may be connected to another device. Use "Bluetooth Audio Pairing" to cancel pairing on the instrument.

The performance data for the instrument's built-in music cannot be transferred

Performance data for built-in music cannot be output from Bluetooth MIDI.

Song Playback

There is no sound even when playing a song (MP3, WAV)

Check that the volume of the USB recorder is not set to the lowest position.

Songs saved on a USB memory device cannot be played back

The song may be in a format that cannot be played back. The speed of the USB memory device being used may be insufficient. Try another USB memory device that supports the USB 2.0 Hi-Speed standard.

The volume of an audio file recorded in MP3/WAV format is too low or too loud (distorted)

Adjust the recording level settings.

Unintended sounds are played during SMF playback, or no sound is produced during SMF playback

This machine does not support the GM standard. Data may be played back with sound that differs from the GM device, or may not be played at all depending on the sound, but this is not a malfunction.

Operation

The touch panel does not operate even when it is touched

There may be water droplets, condensation, or some other substance on the surface of the touchpanel.

How can the instrument be returned to the factory settings?



To return all of the instrument's settings to the factory default configuration:

Use the "Factory Reset" function in the User Data menu.

To return the sound to the factory default configuration:

Select "SK-EX Competition Grand Piano | Rendering Classic".

To return adjusted settings to the factory default configuration:

 settings: Double tap 
 [+] [-] button settings: Double tap the value or item

Sound List

Piano

| |
|---|
| SK-EX Competition Grand Piano Rendering Classic |
| SK-EX Competition Grand Piano Rendering Brilliant |
| SK-EX Competition Grand Piano Rendering Romantic |
| SK-EX Competition Grand Piano Rendering Rich |
| SK-EX Competition Grand Piano Rendering Vintage |
| SK-EX Competition Grand Piano Concert |
| SK-EX Competition Grand Piano Jazz |
| SK-EX Competition Grand Piano Mellow |
| SK-EX Concert Grand Piano Rendering Classic |
| SK-EX Concert Grand Piano Rendering Brilliant |
| SK-EX Concert Grand Piano Rendering Romantic |
| SK-EX Concert Grand Piano Rendering Rich |
| SK-EX Concert Grand Piano Rendering Vintage |
| SK-EX Concert Grand Piano Concert |
| SK-EX Concert Grand Piano Jazz |
| SK-EX Concert Grand Piano Mellow |
| EX Concert Grand Piano Concert |
| EX Concert Grand Piano Mellow |
| EX Concert Grand Piano Standard |
| EX Concert Grand Piano Pop |
| EX Concert Grand Piano Bright |
| EX Concert Grand Piano New Age |
| EX Concert Grand Piano Modern |
| SK-5 Grand Piano Classic |
| SK-5 Grand Piano Jazz |
| SK-5 Grand Piano Pop |
| Upright Piano Classic |
| Upright Piano Boogie |
| Upright Piano Vintage |
| Upright Piano Honky Tonk |

Electric Piano

| |
|-------------------------|
| Tine Electric Piano * |
| Reed Electric Piano |
| Modern Electric Piano |
| Electric Grand |
| Tine Electric Piano 2 |
| Tine Electric Piano 3 |
| Tine Electric Piano 4 |
| Crystal Electric Piano |
| Modern Electric Piano 2 |
| Modern Electric Piano 3 |
| Clavi |
| Organ |
| Jazz Organ * |
| Blues Organ * |
| Ballad Organ |
| Gospel Organ |
| Drawbar Organ |
| Drawbar Organ 2 |
| Drawbar Organ 3 |
| Drawbar Organ 4 |
| Church Organ |
| Church Organ |
| Diapason |
| Full Ensemble |
| Diapason Octave |
| Chiffy Tibia |
| Principal Octave |
| Principal Choir |
| Baroque |
| Soft Diapason |
| Soft Strings |
| Mellow Flutes |
| Medium Ensemble |
| Loud Ensemble |
| Bright Ensemble |
| Full Organ |
| Reed Ensemble |

Harpsichord

Harpsichord *

Harpsichord Octave *

Harpsichord 2

Mallets

Vibraphone

Marimba

Celesta

Bell Split

Strings

Slow Strings

String Pad

Warm Strings

String Ensemble

Soft Orchestra

Chamber Strings

Harp

Pizzicato Strings

Vocal

Choir

Pop Ooh

Pop Aah

Choir 2

Jazz Ensemble

Pop Ensemble

Slow Choir

Breathy Choir

Pad

New Age Pad

Square Pad

Itopia

Atmosphere

Brightness

New Age Pad 2

Brass Pad

Bowed Pad

Bright Warm Pad

Bass

Wood Bass

Electric Bass *

Electric Bass 2 *

Fretless Bass

Wood Bass & Ride

Electric Bass & Ride

Guitar

Ballad Guitar

Pick Nylon Guitar

Finger Nylon Guitar

 **CHECK**

- * : Copyright© PREMIEREngineeringInc.2018 PREMIERSOUNDFACTORY
- Long words may be indicated as an abbreviation on the display.

Drum Rhythm List

8 Beat

8 Beat 1

8 Beat 2

8 Beat 3

Pop 1

Pop 2

Pop 3

Pop 4

Pop 5

Pop 6

Ride Beat 1

Ride Beat 2

DancePop 1

Country Pop

Smooth Beat

Rim Beat

8 Beat Rock

Modern Rock 1

Modern Rock 2

Modern Rock 3

Modern Rock 4

Pop Rock

Ride Rock

Jazz Rock

Surf Rock

16 Beat

16 Beat

Indie Pop 1

Acid Jazz 1

Ride Beat 3

DancePop 2

DancePop 3

DancePop 4

DancePop 5

DancePop 6

DancePop 7

DancePop 8

Indie Pop 2

Cajun Rock

8 Beat Ballad

Pop Ballad 1

Pop Ballad 2

Pop Ballad 3

Rock Ballad 1

Rock Ballad 2

Slow Jam

6/8 R&B Ballad

Triplet Ballad 1

Triplet Ballad 2

16 Beat Ballad

16 Ballad 1

Dance Ballad 1

Dance Ballad 2

Dance Ballad 3

Electro Pop

16 Ballad 2

Mod Pop Ballad

16 Beat Dance

Dance 1

Dance 2

Dance 3

Disco

Techno 1

Techno 2

16 Beat Swing

16 Shuffle 1

16 Shuffle 2

16 Shuffle 3

Acid Jazz 2

Acid Jazz 3

New Jack Swing

Modern Dance

Indie Pop 3

8 Beat Swing

Swing Beat

Motown

Country 2 Beat

Boogie

Triplet

8 Shuffle 1

8 Shuffle 2

8 Shuffle 3

Dance Shuffle

Triplet 1

Triplet 2

Triplet Rock

Reggae

Jazz

H.H. Swing

Ride Swing

Fast 4 Beat

Afro Cuban

Jazz Bossa

Jazz Waltz

5/4 Swing

Latin / Traditional

H.H. Bossa Nova

Ride Bossa Nova

Beguine

Rhumba

Cha Cha

Mambo

Samba

Sala

Merenge

Tango

Habanera

Waltz

Ragtime

March

6/8 March

Sound Demo Song List

| Sound Name | Song Title / Composer |
|-----------------------------------|---|
| SK-EX Competition Grand Rendering | La Campanella / Liszt |
| SK-EX Concert Grand Rendering | Polonaise No.6 "Héroïque" / Chopin |
| SK-EX Competition Grand Jazz | Original / Kawai |
| SK-EX Concert Grand Mellow | Sonata No.30 Op.109 / Beethoven |
| EX Concert Grand Mellow | La Fille aux Cheveux de lin / Debussy |
| EX Concert Grand Standard | Petit chien / Chopin |
| EX Concert Grand Pop | Original / Kawai |
| EX Concert Grand Bright | Original / Kawai |
| EX Concert Grand New Age | Original / Kawai |
| EX Concert Grand Modern | Original / Kawai |
| SK-5 Grand Piano Classic | Lieder Ohne Worte No.18 "Duetto" / Mendelssohn |
| Upright Piano Classic | Nocturne No. 20 Op. posth. / Chopin |
| Tine Electric Piano | Original / Kawai |
| Modern Electric Piano | Original / Kawai |
| Modern Electric Piano / 2 | Original / Kawai |
| Jazz Organ | Original / Kawai |
| Blues Organ | Original / Kawai |
| Drawbar Organ | Original / Kawai |
| Church Organ | Chorale Prelude "Wachet auf, ruft uns die Stimme." / Bach |
| Diapason | Wohl mir, daß ich Jesum habe / Bach |
| Full Ensemble | Original / Kawai |

| Sound Name | Song Title / Composer |
|--------------------|--|
| Harpsichord | French Suite No.6 / Bach |
| Harpsichord Octave | Prelude in Ab / Bach |
| Vibraphone | Original / Kawai |
| Clavi | Original / Kawai |
| Slow Strings | Original / Kawai |
| String Pad | Original / Kawai |
| String Ensemble | Le quattro stagioni La primavera / Vivaldi |
| Choir | Londonderry Air / Irish folk song |
| Choir 2 | Original / Kawai |
| Jazz Ensemble | Original / Kawai |
| New Age Pad | Original / Kawai |
| Square Pad | Original / Kawai |
| Wood Bass | Original / Kawai |
| Electric Bass | Original / Kawai |
| Electric Bass 2 | Original / Kawai |
| Wood Bass & Ride | Original / Kawai |
| Ballad Guitar | Original / Kawai |
| Pick Nylon Guitar | Original / Kawai |

Connecting to Other Devices

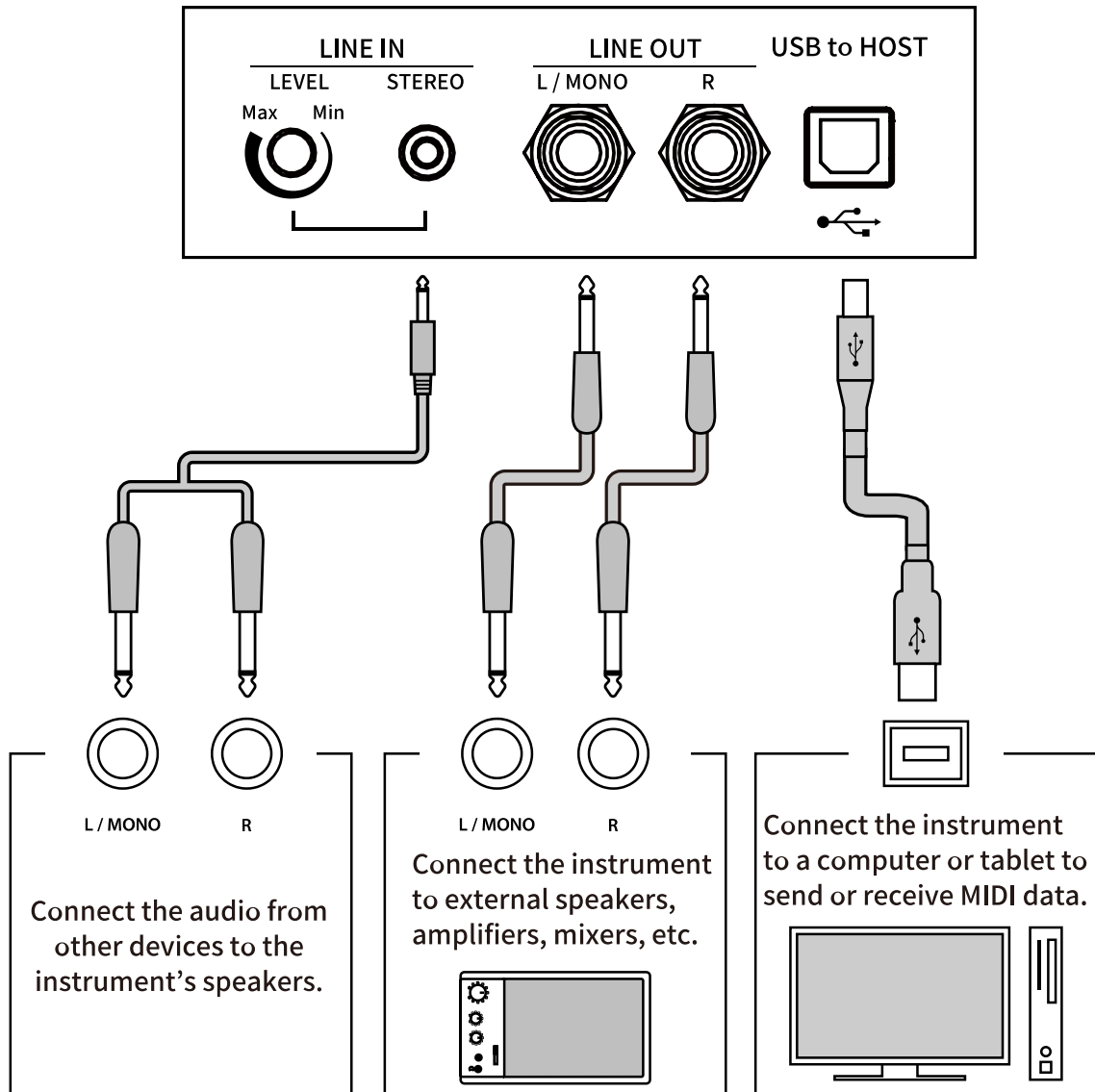

✓ CHECK

- Turn off the power to the digital piano before connecting to other devices.
- Do not connect the digital piano's LINE IN and LINE OUT directly with a cable. Doing so may cause feedback noise and damage the digital piano.

USB drivers

In order to exchange data between this digital piano and a computer via USB connection, the software (USB-MIDI driver) for the digital piano to function properly must be installed in the computer. On most modern operating systems, this driver software will be installed automatically, and additional drivers will not be required.

The USB-MIDI driver to use is different depending on the computer's operating system. For more information, please refer to the following page of the Kawai Global website: <https://www.kawai-global.com/usb>

Smart devices

This product supports connection to smart devices and allows players to use applications designed for the instrument.

Before using this feature, please check the latest information on the supported applications and operating environment, which is available from the Kawai Global website: <https://www.kawai-global.com/usb>

Notes regarding USB TO HOST

- If Bluetooth MIDI and USB are connected simultaneously, Bluetooth MIDI will be given priority.
- Ensure that the digital piano is turned OFF before attempting to connect the digital piano to a computer using a USB cable.
- When the digital piano is connected to a computer by a USB connection, there may be a short delay before communication begins.
- If the digital piano is connected to a computer via a USB hub and operations become unreliable/unstable, connect the USB cable directly to one of the computer's USB ports.
- Disconnecting the USB cable suddenly, or turning the digital piano on/off during operation may cause instability for digital piano or computer operations in the following situations:
 - while installing the driver
 - while starting up the computer
 - while MIDI applications are performing tasks
 - while communicating with a computer
 - while the computer is in energy saver mode
- If there are any further problems experienced with USB MIDI communication while the instrument is connected, please consult your computer's user's manual and double-check all connections and relevant MIDI settings in the computer's operating system.

Notes regarding Bluetooth®

- A variety of devices operate on the 2.4GHz band used by the Bluetooth function. In some situations, the communication speed or communication distance may decrease, or communication may be disconnected due to the influence of other devices.
- This digital piano is always on standby for Bluetooth connection. If there are multiple Bluetooth compatible devices, be careful not to connect to a device other than the one you want to connect to this digital piano.
- MIDI: Complies with Bluetooth (v5.0)/MIDI over Bluetooth Low Energy
- AUDIO: Bluetooth (supports v5.1 A2DP)

Assembly Instructions

⚠ CAUTION

Please ensure that two or more people work on assembling the digital piano. When moving the digital piano, lift it horizontally and be careful not to pinch your hands or fingers or drop it on your feet.

Included parts

Before attempting to assemble the digital piano, confirm that all of the parts are included. A Phillips-head screwdriver (not included) will also be required to assemble the instrument.

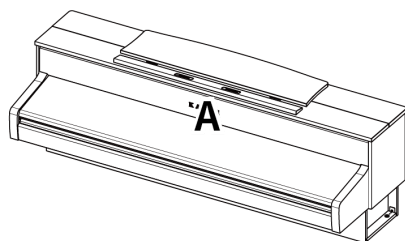

Main body



2 Side panels (left & right)

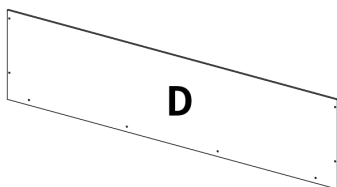

1 Back board

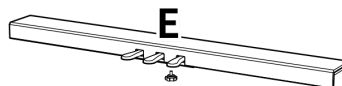

1 Pedal base
1 Pedal adjustor

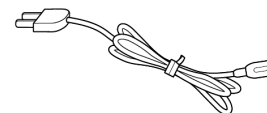

1 Power cable

Screw set

- a** Screw (with washer) x 4



- b** Tapping screw (black, 30 mm) x 4 *



- c** Tapping screw (black, 20 mm) x 4 *



- d** Tapping screw (silver, 16 mm) x 4

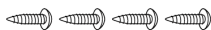

- * **d** Silver screws are provided in a separate bag.
- * For some of the body colours, silver screws are provided instead of black screws.

Headphone hook set

Headphone hook



Mounting screw
(4 x 14 mm) x 2



1. Attaching the side panels (B and C) to the pedal board (E)

- ① Unfasten and extend the pedal connection cable attached to the bottom of the pedal board (E).
- ② Attach the side panels (B and C) to the pedal board (E) using the temporary mounting screws located on either end of the pedal board.
- ③ Ensure that the side panels (B and C) make close contact with the pedal board (E) so that there are no gaps between the parts, and tighten the temporary mounting screws.
- ④ Tighten the loosely fastened long black tapping screws **c** so that the left and right side panels (B and C) and the back board (D) are aligned and in complete contact with no spaces.

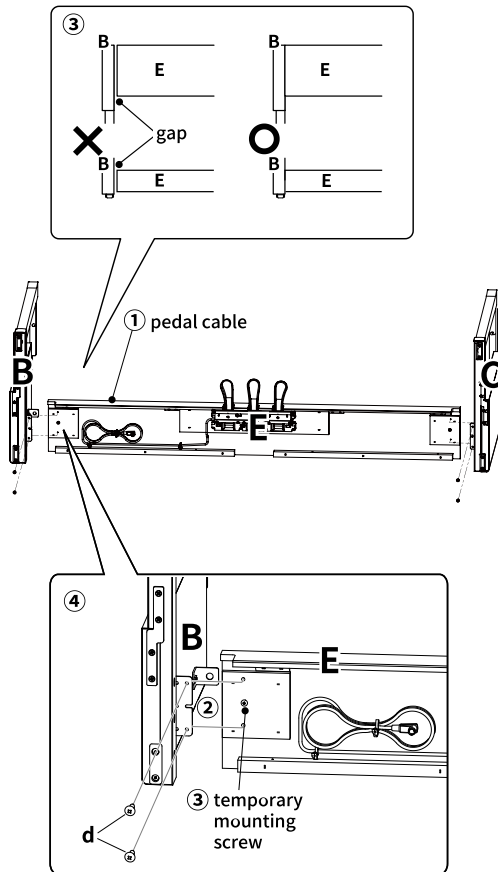

2. Attaching the back board (D)

- ① Stand the assembled structure of the pedal board (E) and side panels (B and C) upright (vertically) on the floor as shown in the illustration below.
At this time, ensure that there are no parts or sheet music on the floor, and that the adjustor bolt is attached to the pedal board.
- ② Loosely attach the back board (D) to the left and right side panels (B and C) using the four long black tapping screws **b**.
- ③ Secure the back board (D) to the pedal board (E) using the four short black tapping screws **c**.
- ④ Tighten the loosely fastened long black tapping screws **c** so that the left and right side panels (B and C) and the back board (D) are aligned and in complete contact with no spaces.

CHECK

Depending on the colour of the instrument, black screws may be replaced with silver screws.

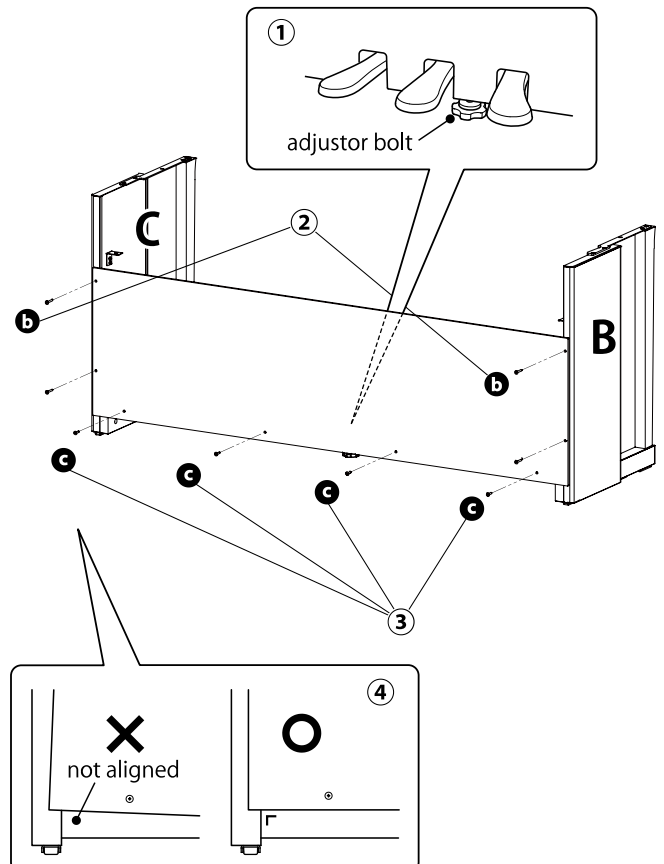

3. Mounting the main body (A) onto the stand

- ① Lift the main body (A) and carefully place it so that the top surface of the left and right side panels (B and C) are visible when viewed from above.
- ② Move the main body (A) forward so that the screw holes on the bottom of the main body are aligned with the holes of the metal fittings on the left and right side panels (B and C). If the screw holes are not visible, loosen the screws that were tightened in 2-(4) and readjust them.

⚠ CAUTION

When lifting the main body (A) onto the stand, be careful not to catch/trap hands and fingers.

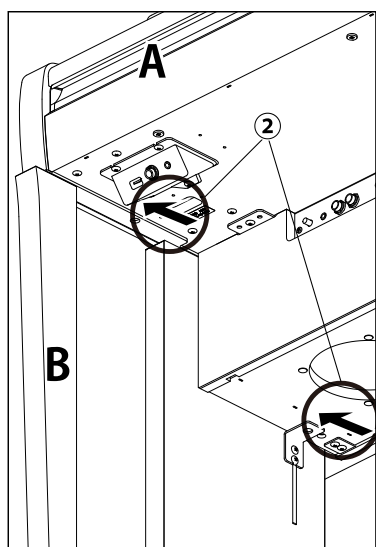
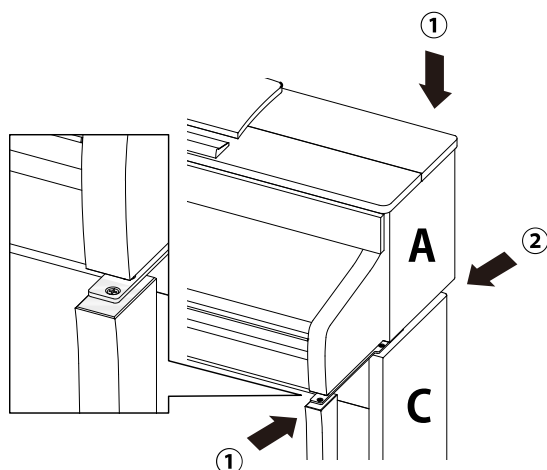

4. Fastening the main body (A) to the stand

- ① Loosely fasten the main body (A) to the stand using four screws (with washer) **a**.
- ② Loosely tighten the screws **a**, and move the main body (A) into position so that the four screws can be inserted straight. Then, adjust the main body (A) so that the overhang of the main body (A) is even on the left and right when viewed from the front.
- ③ Tighten the loosely fastened screws **a** until the spring washer is compressed.

⚠ CAUTION

Tighten all screws securely to ensure that the main body (A) is firmly attached to the stand. It is extremely dangerous if the main body (A) falls from the stand.

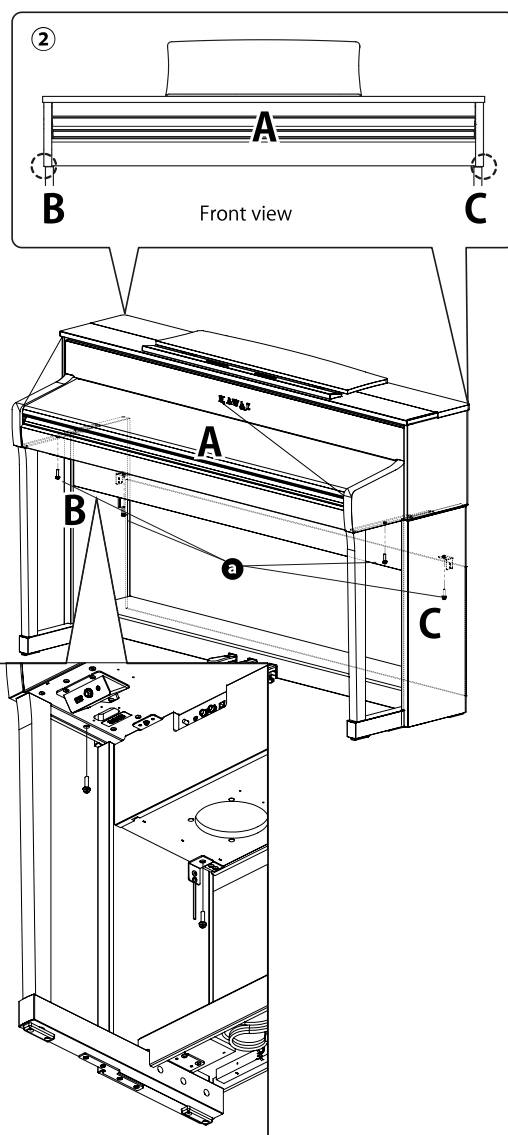

5. Connecting the cables

- ① Pass the pedal connection cable coming out of the pedal board (E) through the aperture of the back board (D) to the back of the instrument, and connect it to the PEDAL terminal on the bottom of the main body (A).
- ② Connect the power cable into the [AC INLET] terminal.
- ③ Use the binders on the side boards (B and C) to fix the cables in place.

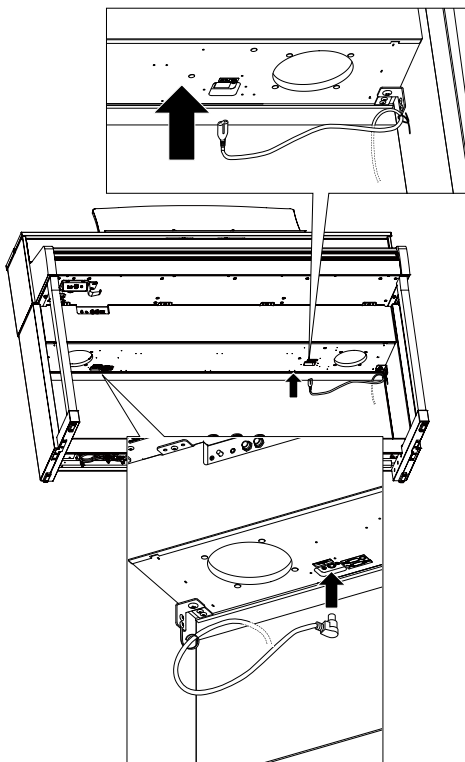

⚠ CAUTION

When inserting the plug at the end of the pedal cable into the jack on the bottom of the main body of the digital piano, be sure to align the pins with the position of the hole in the jack, and then insert the plug straight into the jack as far as it will go. If the plug is forcibly inserted in the improper alignment, the pins may bend or break.

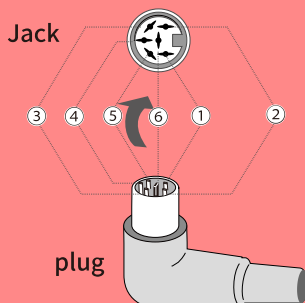

6. Attaching the headphone hook

Attach the headphone hook to the underside of the main body using the two installation screws provided as shown in the illustration below.

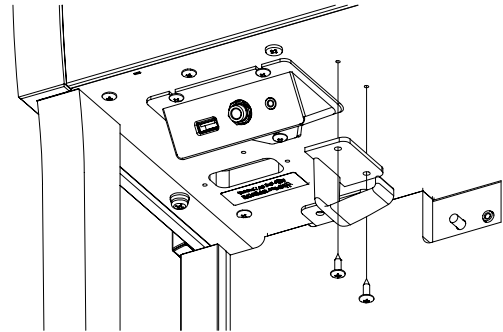

7. Adjusting the pedal support bolt

Be sure to turn the pedal support bolt on the back of the pedal base (E) anti-clockwise to extend the bolt until it makes contact with the floor and supports the pedals firmly. Depending on the material and condition of the floor, there may a noise caused by friction with the floor when the pedal is depressed. If this happens, place felt or carpet between the pedal support bolt and the floor.

⚠ CAUTION

If the instrument is used with the pedal support bolt floating off the floor or pressed strongly against the floor, the pedal board may be damaged. When moving the instrument, lift the instrument off the floor and do not drag it.

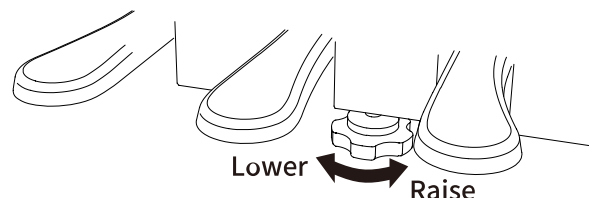

EU Declaration of Conformity

EU Declaration of Conformity

| | |
|---|--|
| BG | ОПРОСТЕНА ЕС ДЕКЛАРАЦИЯ ЗА СЪОТВЕТСТВИЕ |
| Bulgarian | С настоящото Kawai Europa GmbH декларира, че този тип радиосъоръжение [CN201] е в съответствие с Директива 2014/53/ЕС. Цялостният текст на ЕС декларацията за съответствие може да се намери на следния интернет адрес: |
| ES | DECLARACIÓN UE DE CONFORMIDAD SIMPLIFICADA |
| Spanish | Por la presente, Kawai Europa GmbH declara que el tipo de equipo radioeléctrico [CN201] es conforme con la Directiva 2014/53/UE. El texto completo de la declaración UE de conformidad está disponible en la dirección Internet siguiente: |
| CS | ZJEDNODUŠENÉ EU PROHLÁŠENÍ O SHODĚ |
| Czech | Tímto Kawai Europa GmbH prohlašuje, že typ rádiového zařízení [CN201] je v souladu se směrnicí 2014/53/EU. Úplné znění EU prohlášení o shodě je k dispozici na této internetové adrese: |
| DA | FORENKLET EU-OVERENSSTEMMELSEERKLÆRING |
| Danish | Hermed erklærer Kawai Europa GmbH, at radioudstyrstypen [CN201] er i overensstemmelse med direktiv 2014/53/EU. EU-overensstemmelseserklæringens fulde tekst kan findes på følgende internetadresse: |
| DE | VEREINFACHTE EU-KONFORMITÄTSEKTLÄRUNG |
| German | Hiermit erklärt Kawai Europa GmbH, dass der Funkanlagentyp [CN201] der Richtlinie 2014/53/EU entspricht. Der vollständige Text der EU-Konformitätserklärung ist unter der folgenden Internetadresse verfügbar: |
| ET | LIHTSUSTATUD ELI VASTAVUSDEKLARATSIOON |
| Estonian | Käesolevaga deklareerib Kawai Europa GmbH, et käesolev raadioseadme tüüp [CN201] vastab direktiivi 2014/53/EL nõuetele. Eli vastavusdeklaratsiooni täielik tekst on kättesaadav järgmisel internetiaadressil: |
| EL | ΑΠΛΟΥΣΤΕΥΜΕΝΗ ΔΗΛΩΣΗ ΣΥΜΜΟΡΦΩΣΗΣ ΕΕ |
| Greek | Με την παρούσα ο/η Kawai Europa GmbH, δηλώνει ότι ο ραδιοεξοπλισμός [CN201] πληροί την οδηγία 2014/53/ΕΕ. Το πλήρες κείμενο της δήλωσης συμμόρφωσης ΕΕ διατίθεται στην ακόλουθη ιστοσελίδα στο διαδίκτυο: |
| EN | SIMPLIFIED EU DECLARATION OF CONFORMITY |
| English | Hereby, Kawai Europa GmbH declares that the radio equipment type [CN201] is in compliance with Directive 2014/53/EU. The full text of the EU declaration of conformity is available at the following internet address: |
| FR | DECLARATION UE DE CONFORMITE SIMPLIFIEE |
| French | Le soussigné, Kawai Europa GmbH, déclare que l'équipement radioélectrique du type [CN201] est conforme à la directive 2014/53/UE. Le texte complet de la déclaration UE de conformité est disponible à l'adresse internet suivante: |
| HR | POJEDNOSTAVLJENA EU IZJAVA O SUKLADNOSTI |
| Croatian | Kawai Europa GmbH ovime izjavljuje da je radijska oprema tipa [CN201] u skladu s Direktivom 2014/53/EU. Cjeloviti tekst EU izjave o sukladnosti dostupan je na sljedećoj internetskoj adresi: |
| IT | DICHIARAZIONE DI CONFORMITÀ UE SEMPLIFICATA |
| Italian | Il fabbricante, Kawai Europa GmbH, dichiara che il tipo di apparecchiatura radio [CN201] è conforme alla direttiva 2014/53/UE. Il testo completo della dichiarazione di conformità UE è disponibile al seguente indirizzo Internet: |
| LV | VIENKĀRŠOTA ES ATBILSTĪBAS DEKLARĀCIJA |
| Latvian | Ar šo Kawai Europa GmbH deklarē, ka radioiekārta [CN201] atbilst Direktīvai 2014/53/ES. Pilns ES atbilstības deklarācijas teksts ir pieejams šādā interneta vietnē: |
| LT | SUPAPRASTINTA ES ATITIKTIES DEKLARACIJA |
| Lithuanian | Aš, Kawai Europa GmbH, patvirtinu, kad radijo įrenginių tipas [CN201] atitinka Direktivą 2014/53/ES. Visas ES atitikties deklaracijos tekstas prieinamas šiuo interneto adresu: |
| HU | EGYSZERŰSÍTETT EU-MEGFELELŐSÉGI NYILATKOZAT |
| Hungarian | Kawai Europa GmbH igazolja, hogy a [CN201] típusú rádióberendezés megfelel a 2014/53/EU irányelvnek. Az EU-megfelelőségi nyilatkozat teljes szövege elérhető a következő internetes címen: |
| MT | DIKJARAZZJONI SSIMPLIFIKATA TA' KONFORMITÀ TAL-UE |
| Maltese | B'dan, Kawai Europa GmbH, niddikjara li dan it-tip ta' tagħmir tar-radju [CN201] huwa konformi mad-Direttiva 2014/53/UE. It-test kollu tad-dikjarazzjoni ta' konformità tal-UE huwa disponibbli f'dan l-indirizz tal-Internet li ġej: |
| NL | VEREENVOUDIGDE EU-CONFORMITEITSVERKLARING |
| Dutch | Hierbij verklaar ik, Kawai Europa GmbH, dat het type radioapparatuur [CN201] conform is met Richtlijn 2014/53/EU. De volledige tekst van de EU-conformiteitsverklaring kan worden geraadpleegd op het volgende internetadres: |
| PL | UPROSZCZONA DEKLARACJA ZGODNOŚCI UE |
| Polish | Kawai Europa GmbH niniejszym oświadczam, że typ urządzenia radiowego [CN201] jest zgodny z dyrektywą 2014/53/UE. Pełny tekst deklaracji zgodności UE jest dostępny pod następującym adresem internetowym: |
| PT | DECLARAÇÃO UE DE CONFORMIDADE SIMPLIFICADA |
| Portuguese | O(a) abaixo assinado(a) Kawai Europa GmbH declara que o presente tipo de equipamento de rádio [CN201] está em conformidade com a Diretiva 2014/53/UE. O texto integral da declaração de conformidade está disponível no seguinte endereço de Internet: |
| RO | DECLARAȚIA UE DE CONFORMITATE SIMPLIFICATĂ |
| Romanian | Prin prezenta, Kawai Europa GmbH declară că tipul de echipamente radio [CN201] este în conformitate cu Directiva 2014/53/UE. Textul integral al declarației UE de conformitate este disponibil la următoarea adresă internet: |
| SK | ZJEDNODUŠENÉ EÚ VYHLÁSENIE O ZHODE |
| Slovak | Kawai Europa GmbH týmto vyhlasuje, že rádiové zariadenie typu [CN201] je v súlade so smernicou 2014/53/EÚ. Úplné EÚ vyhlásenie o zhode je k dispozícii na tejto internetovej adrese: |
| SL | POENOSTAVLJENA IZJAVA EU O SKLADNOSTI |
| Slovenian | Kawai Europa GmbH potrjuje, da je tip radijske opreme [CN201] skladen z Direktivo 2014/53/EU. Celotno besedilo izjave EU o skladnosti je na voljo na naslednjem spletnem naslovu: |
| FI | YKSINKERTAISTETTU EU-VAATIMUSTENMUKAISUUSVAKUUTUS |
| Finnish | Kawai Europa GmbH vakuuttaa, että radiolaitetyyppi [CN201] on direktiivin 2014/53/EU mukainen. EU-vaatimustenmukaisuusvakuutuksen täysimittainen teksti on saatavilla seuraavassa internetosoitteessa: |
| SV | FÖRENKLAD EU-FÖRSÄKRAN OM ÖVERENSSTÄMMELSE |
| Swedish | Härmed försäkras Kawai Europa GmbH att denna typ av radioustrustning [CN201] överensstämmer med direktiv 2014/53/EU. Den fullständiga texten till EU-försäkrans om överensstämmelse finns på följande webbadress: |
| https://www.kawai-global.com/ | |

Specifications

| | CA901 | CA701 |
|-----------------------|--|---|
| Keyboard | Grand Feel III (GFIII) action, 88 wooden keys | |
| Display | 800x480 pixel 5-inch color LCD touch panel | |
| Polyphony | Max. 256 notes (depending on the selected sound) | |
| Sounds | 106 sounds | |
| Metronome | Beat: 1/4, 2/4, 3/4, 4/4, 5/4, 3/8, 6/8, 7/8, 9/8, 12/8 Rhythm: 100 types | |
| Internal Recorder | 3 song recorder – approximately 90,000 note memory capacity, internal format | |
| USB Recorder | Playback: mp3 (bit rate: 8 k to 320 kbps, sampling frequency: 44.1 kHz, 48 kHz, 32 kHz), Wav (44.1 kHz, 16 bit), SMF Recording: mp3 (bit rate: fixed 256 kbps, sampling frequency: 44.1 kHz), Wav (44.1 kHz, 16 bit) Line-in recording supported | |
| Built-in Songs/Pieces | 578 lesson book songs, 140 Finger Exercises, 39 demo songs, 204 or 218 songs pieces of music | |
| VPA | Touch Curve, Voicing, Damper Resonance, Damper Noise, String Resonance, Cabinet Resonance, Key-off Effect, Fall-Back Noise, Hammer Noise, Hammer Delay, Topboard Simulation, Decay Time, Release Time, Minimum Touch, Stretch Tuning, Temperament, Key Volume, Half-Pedal Adjust, Soft Pedal Depth | |
| Headphone Functions | Spatial Headphone Sound, Headphone Type, Headphone Volume | |
| Bluetooth® Functions | MIDI: Bluetooth (Ver. 5.0)/MIDI over Bluetooth Low Energy compliant Audio: Bluetooth (supports Ver. 5.1 A2DP) | |
| Other Functions | Tuning, Transpose, Favorite, Save Sound, Damper Hold, Tone Control, Low Volume Balance, Speaker Volume, Speaker Character, Wall EQ (CA901 only), Bluetooth Settings Function, MIDI Settings Function, Screen Brightness, Display Size, Auto Display Off, Auto Power Off, Startup Screen, Startup Settings, Language, Factory Reset, Dual/Split/4 Hands Mode (Except when SK-EX Rendering sound source is selected) | |
| Pedals | Damper (with half-pedal support), Soft (with half-pedal support), Sostenuto | |
| Key Cover | Upright piano type (with Soft Fall system) | Sliding type |
| Music Rest | Upright piano type (fixed position) | Collapsible type (adjustable angle: 6 levels) |
| Jacks | LINE IN (1/8" STEREO), LINE IN Level, LINE OUT (1/4" L/MONO, R), Headphones x 2 (1/4", 1/8"), USB to Host, USB to Device, USB for UPDATE | |
| Output Power | 50 W + 50 W + 35 W | 55 W + 55 W |
| Speakers | Soundboard speaker (8 x 12) cm x 2 (top speakers with diffusers) 8 cm x 2 (front speakers) 5 cm x 2 (tweeters) | 13 cm x 2 (woofers) (8 x 12) cm x 2 (top speakers with diffusers) 5 cm x 2 (tweeters) |
| Power Consumption | 55 W | 45 W |
| Dimensions | 1455 (W) x 475 (D) x 1010 (H) mm 57 1/3" (W) x 18 2/3" (D) x 39 3/4" (H) | 1450 (W) x 495 (D) x 970 (H) mm 57" (W) x 19 1/2" (D) x 38 1/5" (H) (music rest flat) |
| Weight | CA901: 82.5 kg / 182 lbs. CA901EP: 91.5 kg / 201 2/3 lbs. | CA701: 76.5 kg / 168 2/3 lbs. CA701EP: 80.0 kg / 176 1/2 lbs. |

* Availability of Bluetooth function dependent on market location.

KAWAI
THE FUTURE OF THE PIANO