

FP-90X FP-60X

Roland Digital Piano
Owner's Manual

 Roland

Look What You Can Do with the FP-90X/FP-60X

Play the Piano

♪ Play various sounds

page 8

This unit contains a wide variety of tones (sounds).
You can freely select and perform using these tones.

♪ Play two layered tones (Dual Play)

page 9

You can layer two tones on a single key.

♪ Play different tones with your left and right hands (Split Play)

page 9

You can divide the keyboard into left and right zones, and select a different tone for each zone.

Live Performance Features

♪ Adjust the tone color (Equalizer)

page 8

You can adjust the character of the sound as appropriate for the location where you're playing the instrument.

♪ Recall performance settings (Registration)

page 23

You can save the settings related to your performance and recall them up anytime, easily.

♪ Add vocals to your performance

page 22

You can connect a microphone (sold separately) to the this unit and add your voice to your performance.
You can even add effects to your vocals.

Convenient Functions

♪ Record your performances

page 18

You can record your own keyboard performance, and then play back to check it.

♪ Bluetooth function

page 12

You can use the **Bluetooth**-compatible app "Piano Every Day" or play back audio from your smartphone.

♪ Personalize your piano (Piano Designer)

page 21

You can customize the individual sound characteristics of the piano sound to create the perfect tone for your performances.

Download the apps

iOS

Android



This app lets you download musical scores and practice songs.

This app lets you customize the piano sound to your taste.

Before using this unit, carefully read "USING THE UNIT SAFELY" and "IMPORTANT NOTES" (leaflet "USING THE UNIT SAFELY" and Owner's Manual (p. 32)). After reading, keep the document(s) including those sections where it will be available for immediate reference.

Placing This Unit on a Stand

For the FP-90X

Be careful not to pinch your fingers when setting up the stand.

Please use one of the following Roland stands to support your FP-90X: KSC-90, KS-G8B, KS-10Z, KS-12 or KS-20X.

Refer to the following when using a stand.

KSC-90

Refer to the KSC-90 Owner's Manual.

KS-G8B

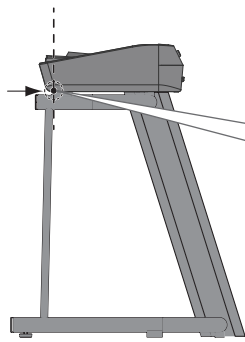

Align the seam in the Piano's panel (on the bottom, near the front) with the corners of the stand's rubber feet

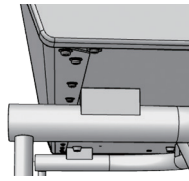

Align the center of the Piano with the center of the stand.



NOTE

For safety, do not use the stand in its very highest adjustment position.

Place the Piano so that its rubber feet are on the inner side of the stand



Top view

KS-10Z

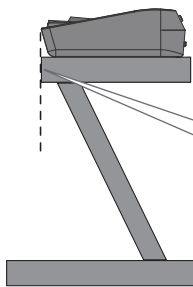

Align the front of the Piano with the front of the stand

NOTE

For safety, do not use the stand in its very highest adjustment position.

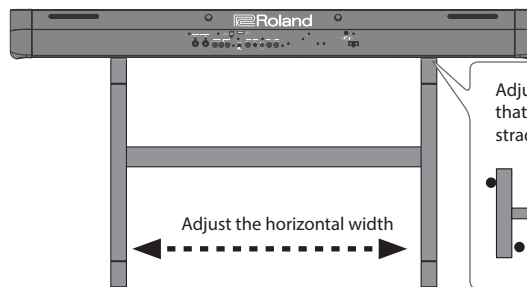

Adjust the horizontal width

Adjust the width of the stand so that the rubber feet of the Piano straddle the stand



Top view

KS-12

Adjust the width of the stand so that the rubber feet on the front of the piano fit into the corresponding openings of the stand



Top view

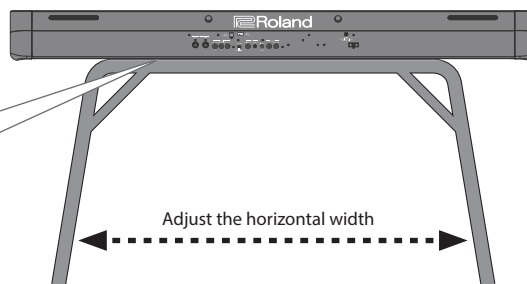

Adjust the horizontal width

NOTE

For safety, do not use the stand in its very highest adjustment position.

KS-20X

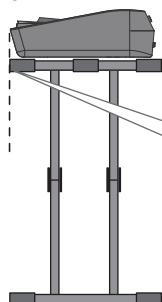

Align the front of the Piano with the front of the stand

Align the center of the Piano with the center of the stand.

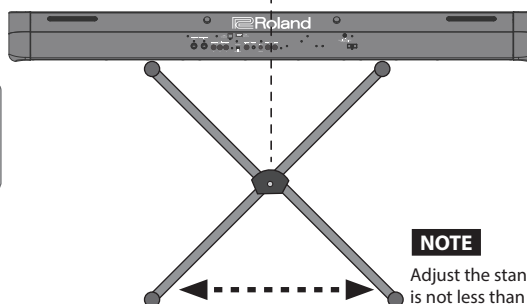

NOTE

Adjust the stand so that its width is not less than 700 mm.

For the FP-60X

Be careful not to pinch your fingers when setting up the stand.

Please use one of the following Roland stands to support your FP-60X: KSC-72, KS-G8B, KS-10Z, KS-12 or KS-20X.

Refer to the following when using a stand.

KSC-72

Refer to the KSC-72 Owner's Manual.

KS-G8B

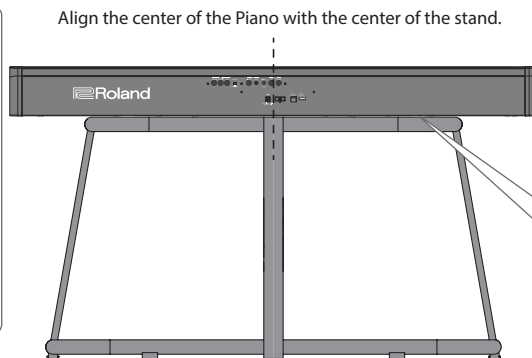
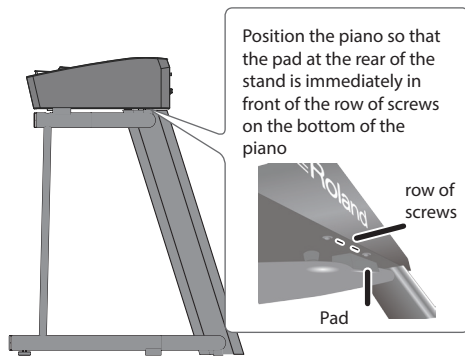

NOTE

For safety, do not use the stand in its very highest adjustment position.

Place the Piano so that its rubber feet are on the inner side of the stand

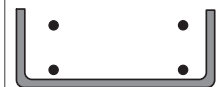

Top view

KS-10Z

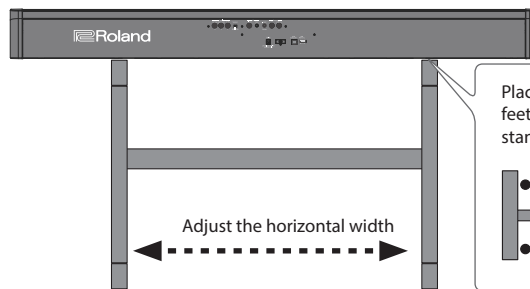
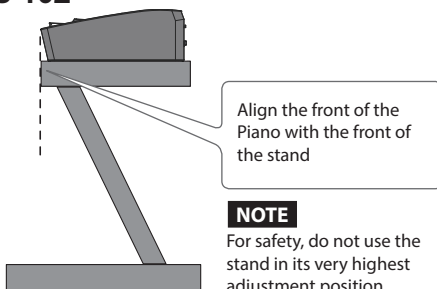

Place the Piano so that its rubber feet are on the inner side of the stand



Top view

KS-12

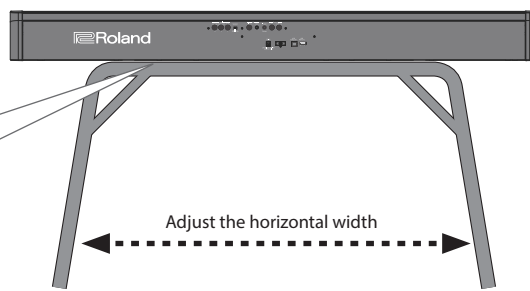
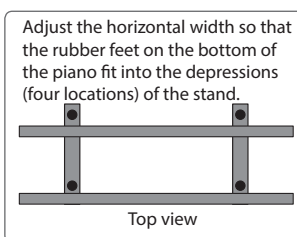

NOTE

For safety, do not use the stand in its very highest adjustment position.

KS-20X

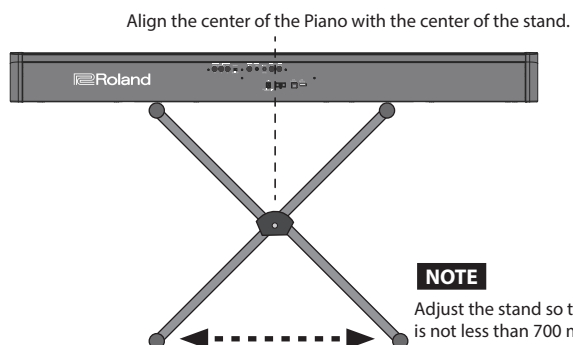
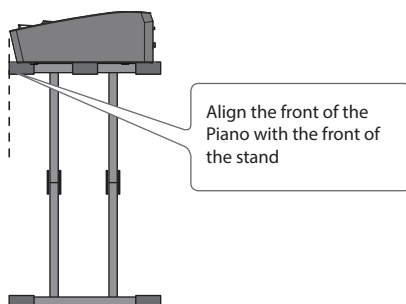

NOTE

Adjust the stand so that its width is not less than 700 mm.

Contents

Placing This Unit on a Stand	2	Returning to the Factory Settings (Factory Reset).....	25
Main Specifications	4	Retaining Settings After Power-Off (Memory Backup)...	25
Panel Descriptions	5	Using USB.....	25
Rear Panel	6	Various Settings (Function Mode).....	26
Basic Operations	7	Adjusting the Keyboard Response (Key Touch).....	26
Operation Guide	8	Matching the Pitch with Other Instruments (Master Tuning)	26
Connecting the Piano and a Mobile Device via Bluetooth	12	Changing the Tuning Method (Temperament)	26
Here's What You Can Do.....	12	Specifying a Song's Tonic (Temperament Key)	26
Listening to Music Through the Piano's Speakers	13	Editing the Equalizer Settings.....	26
Making Initial Settings (Pairing)	13	Transposing the Pitch of the Song Playback (Song Transpose).....	26
Connecting an Already-Paired Mobile Device.....	13	Adjusting the Song Volume (Song Volume).....	27
Playing Back Audio	13	Adjusting the Volume of an Audio Playback Device (Input/Bluetooth Vol.).....	27
Using the Piano with an App	14	Adjusting the Volume from the Computer (USB Audio Input Volume).....	27
Apps You Can Use with This Piano	14	Setting the Song (SMF) Playback Mode (SMF Play Mode)	27
Making Settings (Pairing)	14	Selecting the Format for Recording (Recording Mode) ..	27
If Pairing Does Not Succeed in "Using the Piano with an App".....	15	Changing How the Pedal Effects Are Applied (Damper Pedal Part)	27
Advanced Operation	16	Changing the Function of the Center Pedal (Center Pedal)	27
Playing Various Tones	16	Changing How the Pedal Effects Are Applied (Center Pedal Part)	28
Selecting Your Preferred Performance Environment (My Stage)	16	Sending Tone-Change Information (Transmit MIDI Information)	28
Selecting the Type and Depth of Ambience	16	Preventing Doubled Notes When Connected to a Sequencer (Local Control).....	28
Practicing with the Metronome	16	MIDI Transmit Channel Settings (MIDI Transmit Ch.)	28
Changing the Settings for Metronome.....	17	Adjusting the Brightness of the Display (Display Contrast)	28
Sounding a Click Tone in Synchronization with the Song Tempo (Auto Tempo)	17	Adjusting the Brightness of the Buttons (Panel Brightness)	28
Detecting the Tempo of Your Own Performance (Tempo Coach)	17	Outputting Sound Both from Headphones and Internal Speakers (Speaker Auto Mute)	28
Dividing the Keyboard for Two People (Twin Piano)	17	Making the Power Automatically Turn Off After a Time (Auto Off)	28
Recording Your Performance.....	18	Troubleshooting	29
SMF Recording	18	Error Messages	30
Recording a New Song.....	18	Saved Settings	30
Recording Audio	18	Tone List	31
Convenient Functions for Song Playback.....	19	Internal Song List	31
Renaming a Song (Rename Song)	19	USING THE UNIT SAFELY	32
Copying a Saved Song (Copy Song)	20	IMPORTANT NOTES	32
Deleting a Saved Song (Delete Song)	20		
Personalizing Your Piano Sound (Piano Designer)	21		
Using the Microphone	22		
Connecting a Microphone	22		
Applying an Effect to the Mic (Mic Effects).....	22		
Adjusting the Mic Effect.....	22		
Saving Performance Settings (Registrations)	23		
What Is a Registration?.....	23		
Recalling a Registration	23		
Saving Current Settings into a Registration	23		
Convenient Functions.....	25		
Initializing the Memory (Format Media)	25		

Main Specifications

Roland FP-90X, FP-60X: Digital Piano

	FP-90X	FP-60X
Sound generator	Piano Sound: PureAcoustic Piano Modeling	Piano Sound: SuperNATURAL Piano
Keyboard	PHA-50 Keyboard: Wood and Plastic Hybrid Structure, with Escapement and Ebony/Ivory Feel (88 keys)	PHA-4 Standard Keyboard: with Escapement and Ivory Feel (88 keys)
Bluetooth function	Audio: Bluetooth Ver. 3.0 (Supports SCMS-T content protection) MIDI: Bluetooth Ver. 4.0	
Power Supply	AC adaptor	
Power consumption	40 W (When using the included AC adaptor)	25 W (When using the included AC adaptor)
	* Approximate power consumption when playing the piano at medium volume: 14 W (FP-90X), 5W (FP-60X) * Power consumption when sound has not been played after power-on: 12 W (FP-90X), 4W (FP-60X)	
Dimensions	Detached music rest: 1,340 (W) x 390 (D) x 136 (H) mm 52-13/16 (W) x 15-3/8 (D) x 5-3/8 (H) inches	Detached music rest: 1,291 (W) x 344 (D) x 126 (H) mm 50-7/8 (W) x 13-9/16 (D) x 5 (H) inches
	FP-90X with KSC-90 and music rest: 1,340 (W) x 418 (D) x 932 (H) mm 52-13/16 (W) x 16-1/2 (D) x 36-3/4 (H) inches	FP-60X with KSC-72 and music rest: 1,291 (W) x 382 (D) x 939 (H) mm 50-7/8 (W) x 15-1/16 (D) x 37 (H) inches

	FP-90X	FP-60X
Weight	23.6 kg, 52 lbs 1 oz (FP-90X with music rest)	19.3 kg, 42 lbs 9 oz (FP-60X with music rest)
	37.8 kg, 83 lbs 6 oz (FP-90X with KSC-90, KPD-90, and music rest)	33.0 kg, 72 lbs 13 oz (FP-60X with KSC-72, KPD-90, and music rest)
Accessories	Owner's Manual, Leaflet "USING THE UNIT SAFELY," AC adaptor, Power cord, Music rest, Damper pedal (DP-10, capable of continuous detection)	
Options	Dedicated stand: KSC-90	Dedicated stand: KSC-72
	Dedicated pedal board: KPD-90	
	Keyboard stand: KS-G8B, KS-10Z, KS-12, KS-20X	
	Pedal unit: RPU-3	
	Damper pedal: DP series	
	Pedal switch: DP-2 (Cannot use for Damper/R.)	
	Expression pedal: EV-5	
	Carrying Bag: CB-88RL	
	Headphones	

This document explains the specifications of the product at the time that the document was issued. For the latest information, refer to the Roland website.

Panel Descriptions

Attaching the Music Rest

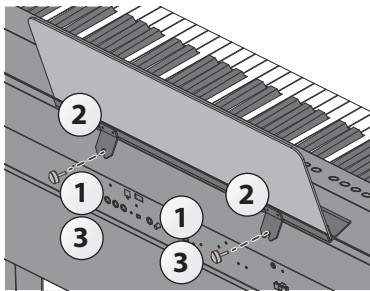

FP-90X

1. Loosen the attachment screws.
2. Fit the cut-outs of the music rest onto the attachment screws.
3. Firmly tighten the attachment screws.

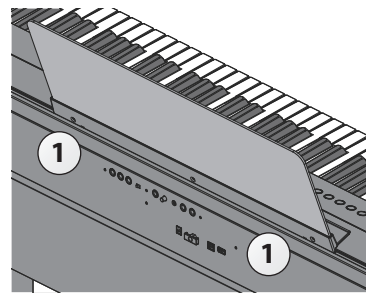

FP-60X

1. Insert the music rest into the slit on the top of the piano.

[⏻] button

Turning On the Power

* Before turning the unit on/off, always be sure to turn the volume down. Even with the volume turned down, you might hear some sound when switching the unit on/off. However, this is normal and does not indicate a malfunction.

1. Move the [Volume] slider all the way down to minimize the volume.

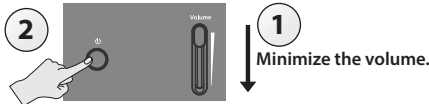

2. Hold down the [⏻] button until the display shows "Roland Digital Piano."

The power turns on, and the tone buttons and other buttons illuminate.

3. Move the [Volume] slider to adjust the volume.

Turning Off the Power

1. Move the [Volume] slider all the way down to minimize the volume.

2. Hold down the [⏻] button until the display shows "Don't disconnect the power."

The unit is turned off.

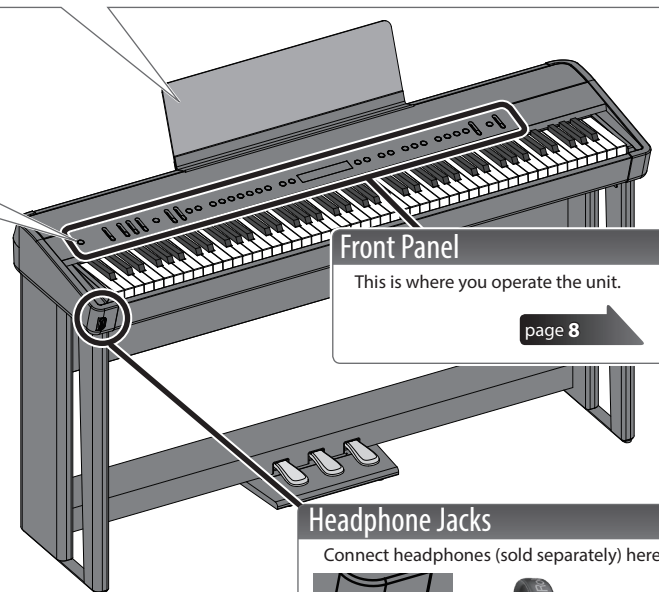

* The illustration shows the FP-90X.

Concerning the Auto Off function

The power to this unit will be turned off automatically after a predetermined amount of time has passed since it was last used for playing music, or its buttons or controls were operated (Auto Off function). If you do not want the power to be turned off automatically, disengage the Auto Off function (p. 28).

- Any settings that you are in the process of editing will be lost when the power is turned off. If you have any settings that you want to keep, you should save them beforehand.
- To restore power, turn the power on again.

Pedals (KPD-90/RPU-3: sold separately)

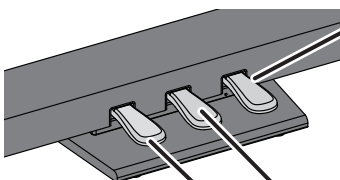

KPD-90 (sold separately)

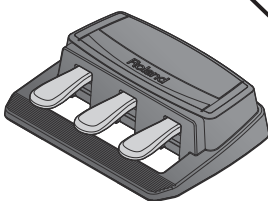

RPU-3 (sold separately)

Damper Pedal

Use this pedal to sustain the sound. While this pedal is held down, notes will be sustained for an extended time even if you release your fingers from the keyboard.

On an acoustic piano, when you step on the damper pedal, you'll first hear the sound of the dampers releasing the strings.

Then, you should also be able to hear the sound of strings adjacent to the ones for the notes actually played resonate sympathetically, resulting in a rich, resounding tone.

Additionally, when using half-pedaling techniques, the core of the sound disappears rapidly while a rich, spacious resonance remains, producing a unique form of reverberation. On the unit, the unique, lingering tones produced by the half-pedaling technique are reproduced in addition to released-string sounds (Damper Noise) and resonating sounds (Damper Resonance).

With the damper pedal on an acoustic piano, when you step on the pedal it will at first offer only a slight amount of resistance, but as you press down further it will start to feel much heavier. On KPD-90, this change in the feeling of resistance is simulated.

Sostenuto Pedal

The notes you are pressing when this pedal is depressed will be sustained.

Soft Pedal

This pedal is used to make the sound softer. Playing with the soft pedal depressed produces a sound that is not as strong as when otherwise played with the equivalent strength. This is the same function as the left pedal of a grand piano. The softness of the tone can be varied subtly by the depth to which you press the pedal.

* When operating the pedal, take care not to pinch your fingers between the moving part and the body of the unit. Pay special attention to this when using the unit where children are present.

English

日本語

Deutsch

Français

Italiano

Español

Português

Nederlands

简体中文

Panel Descriptions

🎵 Rear Panel

Connect pedals and USB flash drive.

* To prevent malfunction and equipment failure, always turn down the volume, and turn off all the units before making any connections.

FP-90X

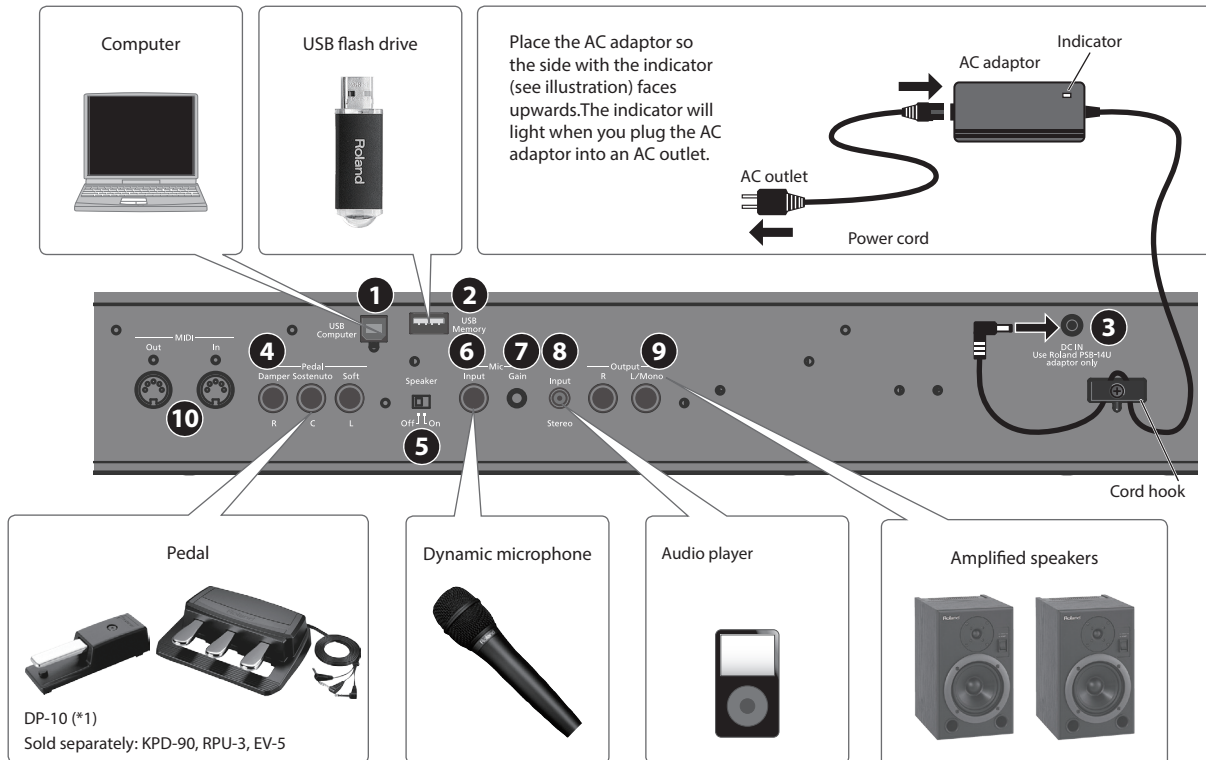

FP-60X

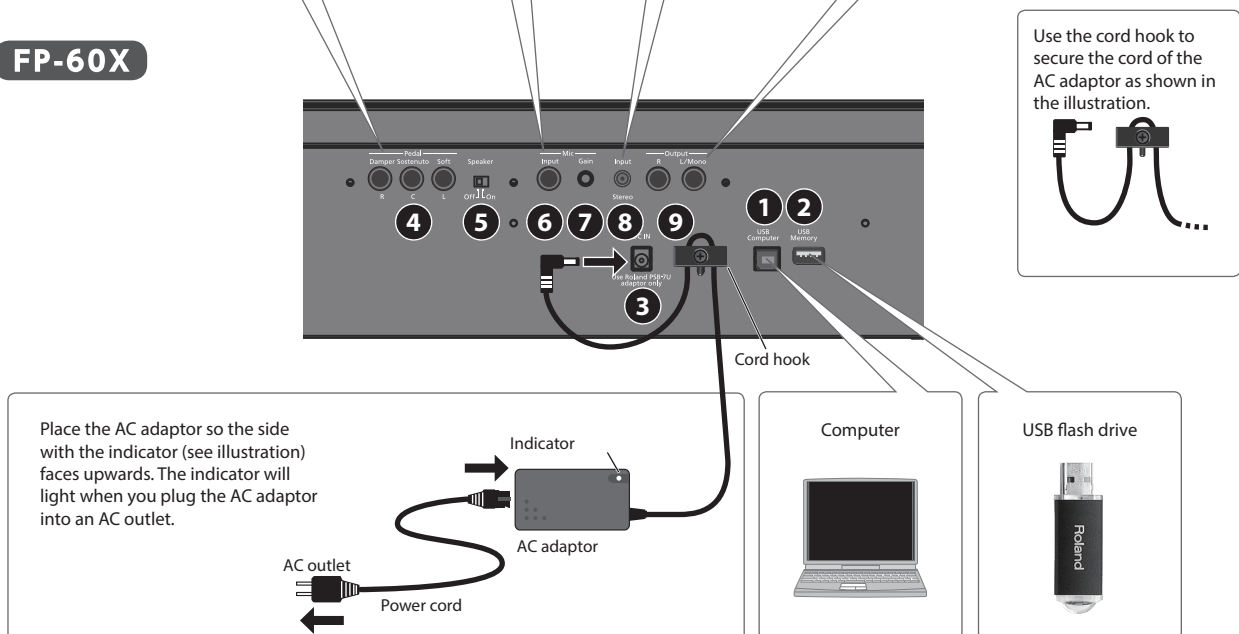

*1 When operating the pedal, take care not to pinch your fingers between the moving part and the body of the unit. Pay special attention to this when using the unit where children are present.

1 USB Computer port

Here you can connect your computer via a USB cable (sold separately). If your computer is connected, performance data can be transferred between the piano and sequencer software (sold separately) on your computer, allowing you to produce or edit music.

2 USB Memory port

You can use USB flash drives (sold separately) to do the following.

- Play WAV files, MP3 files, and standard MIDI files (SMF files) copied from your computer.
- Make audio recordings of your Piano
- Export/Import a registration set.
- * Never turn off the power or disconnect a USB flash drive or the power cord while the screen indicates "Executing ..."

3 DC In jack

Connect the included AC adaptor here.

4 Pedal Damper/Sostenuto/Soft jacks

Connect pedals to these jacks.

- * Do not connect any pedal other than the specified pedal to the Pedal Damper jack.
- * The EV-5 is compatible only with the Pedal Sostenuto/Soft jack.

5 Speaker [Off/On] switch

Turns the piano's speakers on or off.

6 Mic Input jack

Connect the dynamic microphone (sold separately) here. This is a 1/4" phone (unbalanced) jack.

7 Mic [Gain] knob

Adjust the microphone's gain.

8 Input Stereo jack

Connect an audio player here.

- * If you use a cable that contains a built-in resistor, the volume of the device connected to the Input Stereo jack might be decreased. Use a connection cable that does not contain a resistor.

9 Output R, L/Mono jacks

You can output the sound of piano to amplified speakers.

10 MIDI Out/In jacks **FP-90X**

Connect MIDI devices here. You can record your piano performance as MIDI data on a MIDI device, or use MIDI data from a MIDI device to play the piano.

Basic Operations

On this piano, you can use the buttons of the operating panel to make various function settings.

The "◀", "▶", "-", "+", "Enter (Func)", and "Exit" indications shown in the screen indicate the buttons used to operate the various functions.



Upper line: shows the category to specify
(you can use the [◀] [▶] buttons to change this)

Lower line: shows the value within the category
(you can use the [-] [+] buttons to change this)

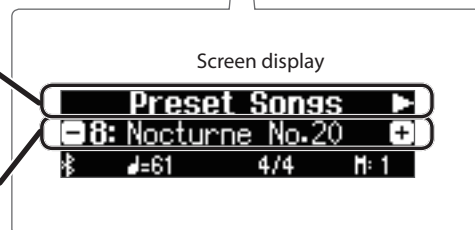
**Selecting the category to set**

Use the [◀] [▶] buttons to select the category that you want to set.

Selecting values within a category

Use the [-] [+] buttons to change a value within the category.

"Enter" and "Exit"

Use the [Function] (Enter) button to confirm the selected category or value.

Use the [Exit] button to go back to the previous operation.

Operation Guide

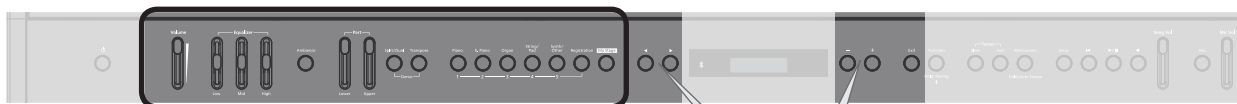

Selecting a Tone (Single)

In addition to piano sounds, the unit lets you enjoy performing with many other sounds.

These sounds are called "Tones." The Tones are divided into five groups, each of which is assigned to a different Tone button.

Tone groups

[Piano] button	Allows you to select various historical instruments, including grand pianos, or harpsichords.
[E. Piano] button	Allows you to select various electric piano sounds used in pop or rock.
[Organ] button	Allows you to select organ tones. If you've selected a tone to which the rotary effect is applied, pressing the [Organ] button will switch the speed of the rotary effect.
[Strings/Pad] button	Allows you to select sounds of instruments used in an orchestra, mainly string instruments such as violins, as well as synth pad sounds.
[Synth/Other] button	Allows you to select sounds that are unique to synthesizers, as well as vocal and GM2 sounds.

MEMO

When playing a tone that uses tremolo or has a vibrating quality, you can adjust the speed of the modulation by holding down the current Tone button and pressing the Tempo [Slow] [Fast] buttons.

Basic operations

Select a setting item	Press the [◀] [▶] buttons.
Edit a value	Press the [-] [+] buttons.
Restore the default value	Press the [-] [+] buttons simultaneously.
Cancel an operation	Press the [Exit] button.

To select a tone

1. Press a tone button (e.g., [Piano]) and then use the [-] [+] buttons.

Viewing the display

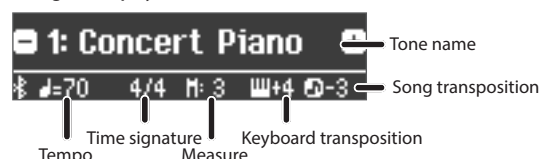

Auditioning the tones (Tone Demo)

1. Hold down the [Split/Dual] button and press the [Transpose] button.
2. Press one of the Tone buttons.

The tone used for the demo song depends on which Tone button you press.

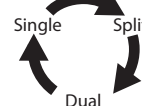

By pressing the [Dual/Split] button, you can sequentially cycle between "Single," "Split," and "Dual."

Changing the Keyboard Volume Balance (Part Volume)

When using Split Play or Dual Play, you can adjust the keyboard's volume balance.

	[Lower] slider	[Upper] slider
When using Normal (Single) Play	Not used	Adjusts the volume of the keyboard.
When using Split Play	Adjusts the volume of the region below the split point.	Adjusts the volume of the region above the split point.
When using Dual Play	Adjusts the volume of tone 2.	Adjusts the volume of tone 1.

Adjusting the Overall Volume

You can adjust the speaker volume when using the internal speakers, or the headphone volume when headphones are connected.

Adjusting the Tone Color (Equalizer)

Use these sliders to boost or cut the sound in the Low, Mid, and High frequency ranges.

page 26

Adjusting the Ambience (Ambience)

1. Press the [Ambience] button.

FP-60X

- 1-2. Press the [Function] (Enter) button.

2. Use the [◀] [▶] buttons to select the "ambience type."

This lets you change the acoustical character of the sound.

3. Use the [-] [+] buttons to specify the "ambience depth."

This lets you adjust the acoustical character (ambience) of the sound.

MEMO FP-60X

You can adjust the acoustical character of the sound heard in headphones (Headphones 3D Ambience) (p. 16).

page 16

Transposing Your Performance (Transpose)

The keyboard can be transposed in semitone steps.

If you play C E G → It will sound E G# B

For example if a song is in the key of E major but you want to play it using the fingering of the C major scale, you would set the keyboard transpose setting to "4."

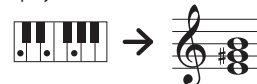

1. While holding down the [Transpose] button, press the [-] [+] buttons.

The display will indicate the amount of transposition.

2. To cancel the transposition, press the [Transpose] button once again.

The [Transpose] button will go out.

Kbd Transpose -6-0-+5 (default value: 0)

MEMO

You can also change the keyboard transpose setting by holding down the [Transpose] button and pressing the note that will be the tonic (root note) of the transposed key.

Playing Different Tones with the Right and Left Hands (Split)

You can play different tones in the areas at the left and right of a specified key. For example, you can use your left hand to play a bass tone and use your right hand to play a piano tone. This feature is called "Split Play," and the point at which the keyboard is divided is called the "split point."

Turning Split Play on Press the [Split/Dual] button several times to access the Split screen.

The following settings can be operated when the Split screen is shown.

Changing the right-hand tone and left-hand tone (Right Tone/Left Tone)	<ol style="list-style-type: none"> 1. Use the [◀] [▶] buttons to select "right-hand tone" or "left-hand tone." 2. Press a tone button. 3. Use the [-] [+] buttons.
Changing the split point (Split Point)	<ol style="list-style-type: none"> 1. Use the [◀] [▶] buttons to select "Split Point." 2. Use the [-][+] buttons to specify the value. <p>MEMO You can also specify the split point by holding down the [Split/Dual] button and pressing the key where you want to split the keyboard.</p> <p>B1-B6 (default value: F#3)</p>
Changing the octave of the right-hand tone and left-hand tone (Right Shift/Left Shift)	<ol style="list-style-type: none"> 1. Use the [◀] [▶] buttons to select "Right Shift" or "Left Shift." 2. Use the [-][+] buttons to specify the value. <p>-3-0-+3 (default value: 0)</p>

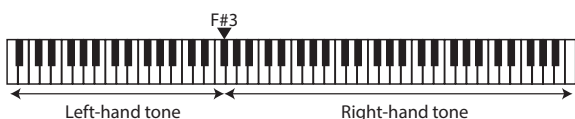

- * Depending on the combination of tones, the effect might not apply to the left-hand tone, causing the sound to appear differently than usual.
- * If you select a sound from the [Piano] button as the left-hand tone, it might sound different than usual.

Layering two tones (Dual)

You can play two tones simultaneously from a single key. This function is called "Dual Play."

Turning Dual Play on Press the [Split/Dual] button several times to access the Dual screen.

MEMO
You can also use Dual Play by pressing two tone buttons simultaneously.

The following settings can be operated when the Dual screen is shown.

Changing tone 1 and tone 2 (Tone 1/Tone 2)	<ol style="list-style-type: none"> 1. Use the [◀] [▶] buttons to select "tone 1" or "tone 2." 2. Press a tone button. 3. Use the [-] [+] buttons.
Changing the octave of tone 1 or tone 2 (Tone 1 Shift/Tone 2 Shift)	<ol style="list-style-type: none"> 1. Use the [◀] [▶] buttons to select "Tone 1 Shift" or "Tone 2 Shift." 2. Use the [-][+] buttons to specify the value. <p>-3-0-+3 (default value: 0)</p>

- * Depending on the combination of tones, the effect might not apply to tone 2, causing the sound to appear differently than usual.
- * If you select a sound from the [Piano] button as tone 2, it might sound different than usual.

Reading the note name (e.g., C4)

The alphabetical indication for settings such as Split Point shows the name of the note. In solfège, A = la, B = ti, C = do ... G = so.

For example, the indication "C4" means "the fourth 'C' from the left edge of the keyboard."



Recalling Performance Settings (Registration)

You can use the registration feature to save the current performance settings into a "registration" that you can recall whenever you wish.

page 23

By switching the registration, you can instantly recall saved settings.

Recalling a registration

1. Press the [Registration] button.
2. Press one of the number buttons, from [1] to [5], to select the registration.
3. Press the [-] [+] buttons to select the registration variation.

Saving current settings into a registration

1. Set the desired performance settings.
2. While holding down the [Registration] button, press a button from [1] to [5] to select a registration and then press the [-] [+] buttons to select a registration variation.
3. Use the [-] [+] buttons and the [◀] [▶] buttons to give a name to the registration.
4. Press the [Function] button to save.

MEMO

For details on the settings that can be stored, refer to "Saved Settings" (page 30).

Selecting a Favorite Performance Environment (My Stage)

By selecting My Stage, you can enjoy your favorite piano and performance environment in your own home. This function reproduces the sound and resonance that you would experience when playing an ideally-matched grand piano in various environments such as a concert hall, church, or rehearsal studio.

page 16

Selecting a My Stage

1. Press the [My Stage] button.
2. Use the [-][+] buttons to select the desired performance environment.

MEMO

You can save your favorite My Stage settings in a registration (p. 23).

English

日本語

Deutsch

Français

Italiano

Español

Português

Nederlands

简体中文

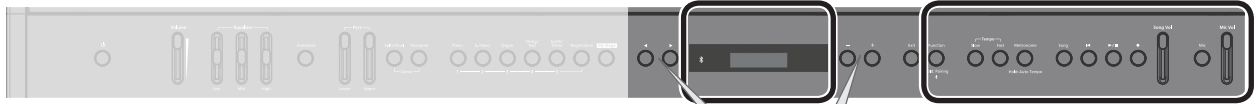

Display

The display shows information such as the tone name, song name, tempo, and time signature.

Basic operations

Select a setting item	Press the [◀] [▶] buttons.
Edit a value	Press the [-] [+] buttons.
Restore the default value	Press the [-] [+] buttons simultaneously.
Cancel an operation	Press the [Exit] button.

Single

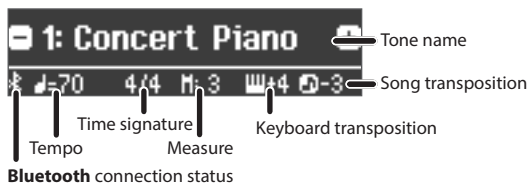

Split



Dual

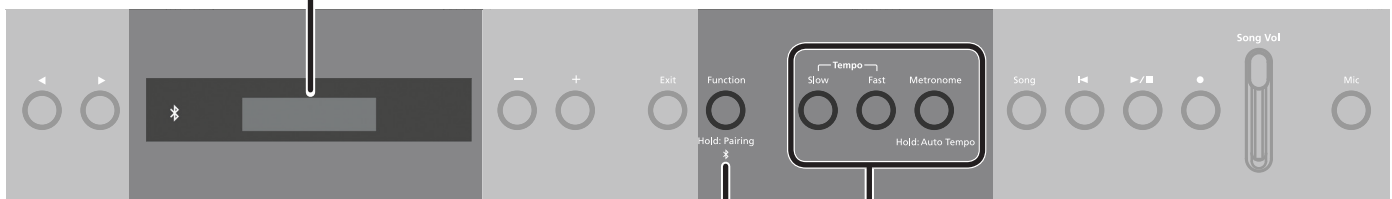
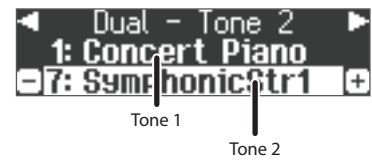

Various Settings (Function Mode)

You can make detailed settings for the unit.

p. 25

1. Press the [Function] button.
2. Use the [◀] [▶] buttons to select the item that you want to adjust.
3. Use the [-] [+] buttons to adjust the value.

* By long-pressing the [Function] button, you can begin pairing with a Bluetooth device.

Sounding a Click at the Song's Tempo (Auto Tempo)

You can sound a click tone in synchronization with the tempo of a song that is input from an external audio source (Bluetooth audio, the Input Stereo jack, or USB audio).

In this example, we'll sound a click tone in synchronization with the tempo of a song played from an audio player connected to the Input Stereo jack.

1. Connect your audio player to the Input Stereo jack.
2. Play back a song on your audio player.
The song is heard from the piano's speakers.
3. While the song is playing, long-press the [Metronome] button.
Auto tempo turns on, and the click tone is sounded in synchronization with the tempo of the song.

MEMO

Even in the middle of the song, you can update the tempo as many times as you like by long-pressing the [Metronome] button once again.

4. To stop using auto tempo, press the [Metronome] button to make it go dark.

MEMO

For details on the auto tempo setting, see the following.

page 17

Using the Metronome

You can sound a metronome while you perform. You can also change the tempo and time signature of the metronome.

If a song is playing, the metronome sounds at the tempo and time signature of that song.

Sounding the Metronome

1. Press the [Metronome] button so it's lit.
The metronome is sounded.
2. To stop the metronome, press the [Metronome] button once again to make it go dark.

Change the Metronome tempo

1. Use the Tempo [Slow] [Fast] buttons to change the tempo.

Tempo range	10–500
-------------	--------

MEMO

For details on the metronome settings, see the following.

page 16

Selecting a Song

Access the song screen, and select a song.

1. Press the [Song] button to access the song screen.

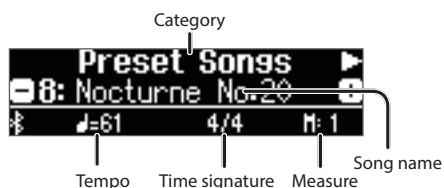

2. Press the [◀] [▶] buttons to select a category.
3. Press [-] [+] buttons to select a song.
4. Press the [▶/■] button to play the song.

MEMO

To select a song from a folder on a USB flash drive, proceed as follows.

To open a folder	Use the [-] [+] buttons to select the folder, and press the [▶/■] button.
To close a folder	Use the [-] button to select " (up)" and then press the [▶/■] button.

Category list

Category	Explanation
Preset Songs	Songs built into the piano
USB Memory	Songs saved on a USB flash drive
Internal Memory	Songs saved in internal memory

NOTE

* When the SMF Play Mode (p. 27) is set to "Auto-Select" or "Internal," there are some parts whose volume is not affected by the [Song Vol.] slider (on the FP-60X, the function mode setting "Song Vol.>"). If the SMF Play Mode is set to "External," the volume of all parts will change.

Song formats that can be played by the unit

The unit can play back data in the following formats.

Song format	Explanation
MIDI files	SMF format 0/1
Audio files	WAV format, 44.1 kHz, 16-bit linear
	MP3 format, 44.1 kHz, 64 kbps–320 kbps

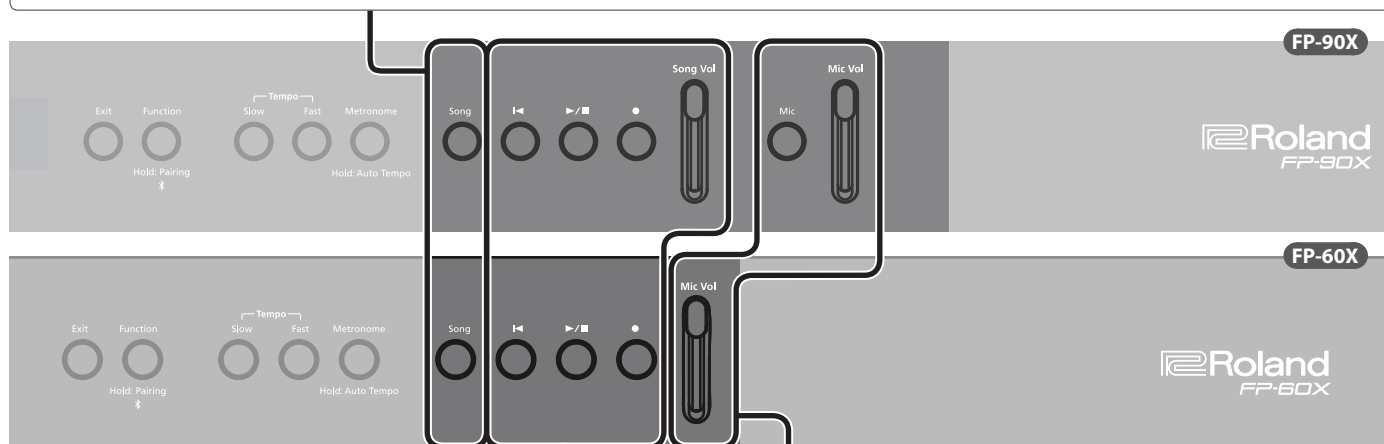

Playing Back or Recording

Here's how to play back or record a song.

Play/stop

p. 19

1. Press the [▶/■] button.

Return to the beginning of the song

1. Press the [◀] button.

Change the song tempo

1. Use the Tempo [Slow] [Fast] buttons to change the tempo.

Record

p. 18

1. Select the tone that you want to play.
2. You can sound the metronome if you like.

You can specify the tempo and time signature of the metronome. The metronome's tempo and time signature settings are stored in the song, so that the metronome plays correctly even when you play back the song.

3. Press the [●] button.

The [●] button lights, the [▶/■] button blinks, and the unit enters record-standby mode.

If you decide to cancel recording, press the [●] button once again.

4. Press the [▶/■] button to start recording.
5. Press the [▶/■] button to stop recording.

Using a Mic (Mic)

You can connect a mic to the this unit and mix the sound of its performance with the sound from the mic.

p. 22

Adjusting the Volume of the Song

FP-90X

1. Use the [Song Vol.] slider to adjust the volume of the song.

This adjusts the volume of the song (SMF/audio).

Adjusting the Volume of the Song

FP-60X

This adjusts the volume of the song (SMF/audio).

1. Press the [Function] button.
2. Use the [◀] [▶] buttons to select Song Vol.
3. Use the [-] [+] buttons to adjust the volume.

* Some of the tones used in the tone demo are set to be adjusted by the Part [Upper] [Lower] slider. If you want to use the [Song Vol.] slider (on the FP-60X, the function mode setting "Song Vol.>") to adjust all of the parts, change SMF Play Mode (p. 27) to "External."

Connecting the Piano and a Mobile Device via **Bluetooth**



Here's What You Can Do

By using the **Bluetooth** function, you can wirelessly connect the piano with a mobile device such as your smartphone or tablet, allowing you to do the following things.

Music played back by the mobile device can be heard through the piano's speakers.

You can play back music data that's saved on your iPhone or other mobile device, and wirelessly listen to it through the piano's speakers.

→ "Listening to Music Through the Piano's Speakers"

page 13

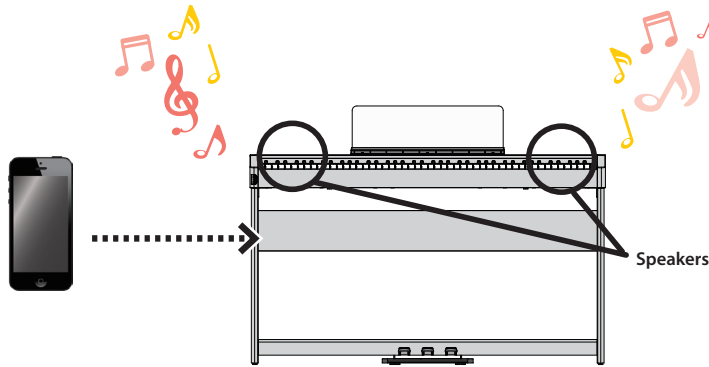

You can use apps to expand your piano enjoyment.

You can install apps (such as Roland's "Piano Every Day" or "Piano Designer") on your mobile device, and use them in conjunction with the piano.

→ "Using the Piano with an App"

page 14

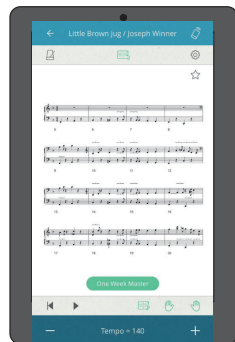

App [Piano Every Day]

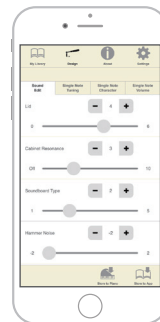

App [Piano Designer]

Pairing

To wirelessly connect the piano with your mobile device, you must first perform "pairing" to create a one-to-one connection between the piano and your mobile device.

"Pairing" is the procedure of registering (mutually authenticating) your mobile device with the piano.

Pair your device as described in the procedure for each function.

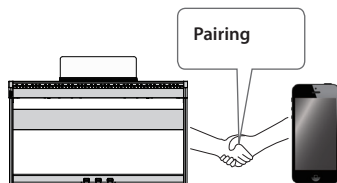

The pairing process

Separate pairing is required for "playing music through the piano's speakers" and for "using the piano with an app." Note that these processes are different.

Playing music through the piano's speakers

Using the piano with an app



Settings on the piano



Settings on the mobile device



Settings on the mobile device



Settings on the App

* If pairing is not successful, refer to If Pairing Does Not Succeed in "Using the Piano with an App" (p. 15).

Listening to Music Through the Piano's Speakers

Here's how to make settings so that music data saved on your mobile device can be wirelessly played back through the piano's speakers.

* If your mobile device is already paired with the piano, there is no need to perform pairing again. Refer to "Connecting an Already-Paired Mobile Device" (p. 13).

Making Initial Settings (Pairing)

As an example, we explain how to make settings for an iPad. If you're using an Android device, refer to the owner's manual of the mobile device you're using.

1. Place the mobile device that you want to connect near the piano.

MEMO

You can also initiate pairing by long-pressing the [Function] button instead of performing steps 2–4.

2. Long-press the [Function] button.

When the display indicates "Now Pairing...," proceed to step 5.

2. Press the [Function] button, and then use the [◀] [▶] buttons to select "Bluetooth."



3. Press the [Function] (Enter) button.

The **Bluetooth** screen appears.



4. Use the [◀] [▶] buttons to select "Bluetooth Pairing," and then press the [Function] (Enter) button.

The display indicates "Now pairing...," and the piano waits for a response from the mobile device (pairing start).

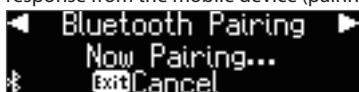

* If you decide to cancel pairing, press the [Exit] button.

5. Turn on the **Bluetooth** function of the mobile device.

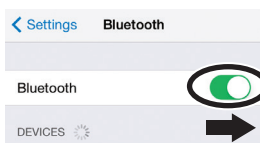

6. Tap "FP-90X Audio" or "FP-60X Audio" that is shown in the **Bluetooth** device screen of your mobile device.

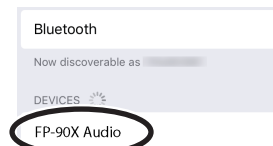

* If the mobile device's screen asks you to enter a "Pass Key," enter "0000" (four zeros).

The piano and mobile device are paired. When pairing is completed, a display like the following appears.

Mobile device	"FP-90X Audio" or "FP-60X Audio" are added in the "My Devices" field
Piano	The "AUDIO" is shown beside the Bluetooth symbol

7. Press the [Exit] button several times to exit Function mode.
This completes initial settings.

Connecting an Already-Paired Mobile Device

1. Turn on the **Bluetooth** function of the mobile device.
The piano and the mobile device are wirelessly connected.

MEMO

If you were unable to establish a connection using the procedure above, tap "FP-90X Audio" or "FP-60X Audio" that is displayed in the **Bluetooth** device screen of the mobile device.

Playing Back Audio

When you play back music data on the mobile device, the sound is heard from the piano's speakers.

Adjusting the volume of **Bluetooth** audio

Normally you'll adjust the volume on your mobile device. If this does not provide the volume adjustment you want, you can adjust the volume as follows.

1. Proceed with steps 2–3 of "Making Initial Settings (Pairing)" (p. 13).
2. Use the [◀] [▶] buttons to select "Input/Bluetooth Vol.," and use the [-] [+] buttons to adjust the volume.



To pair your device with multiple pianos

For example, if you want to pair your mobile device with multiple pianos located in a music school, you can specify an **Bluetooth ID** for each piano to pair your mobile device with the desired pianos.

* When you make this setting, an ID number is added to the end of the device name shown on the mobile device (e.g., FP-90X Audio1).

1. Perform steps 2–3 of "Making Initial Settings (Pairing)" (p. 13).
2. Use the [◀] [▶] buttons to select "Bluetooth ID."

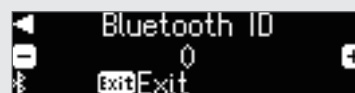

3. Use the [-] [+] buttons to edit the value of the setting.

FP-90X

Value	Explanation
0–99	Set to "0": "FP-90X Audio""FP-90X MIDI" (default value) Set to "1": "FP-90X Audio 1""FP-90X MIDI 1"

FP-60X

Value	Explanation
0–99	Set to "0": "FP-60X Audio""FP-60X MIDI" (default value) Set to "1": "FP-60X Audio 1""FP-60X MIDI 1"





* If you are pairing in an environment where there are multiple pianos, we recommend that you turn on the power of the mobile device and only those pianos that you want to pair (turn off the power of other devices).

Connecting the Piano and a Mobile Device via Bluetooth

Using the Piano with an App

Here's how to make settings so that you can use the piano with an app that's installed on your mobile device.

Apps You Can Use with This Piano

App name	Supported OS	Explanation
 Piano Every Day	iOS Android	This app lets you download electronic scores, practice songs as if you were playing a game, or keep a record of your practicing. 
 Piano Designer	iOS Android	This app lets you customize the piano sound to your taste. It provides touch-based editing within the app for the various elements of the sound in "Creating Your Own Piano Tone (Piano Designer)" (p. 21). 

- * Apps can be downloaded from the App Store or Google Play (free of charge).
- * In addition to the above, you can also use music apps (such as Garage Band) that are compatible with **Bluetooth MIDI**.
- * The information provided about apps made by Roland was current when this manual was published. For the latest information, refer to the Roland website.

Making Settings (Pairing)

You can make settings for using the piano together with an app that's installed on your mobile device. As an example, we'll explain the procedure for using an iPad with the "Piano Every Day" app.

- * In the case of "using the piano with an app," settings on the piano are not necessary. Perform operations in the app to pair it with the piano.

1. Turn on the Bluetooth function of the mobile device.

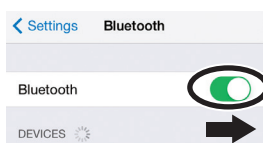

NOTE

Even if the "DEVICES" field shows the name of the device you're using (such as "FP-90X MIDI"), do not tap it.

2. Start the app that you installed on your mobile device.

3. Tap the menu located in the lower right of the app screen, and then in the menu screen tap "Bluetooth."

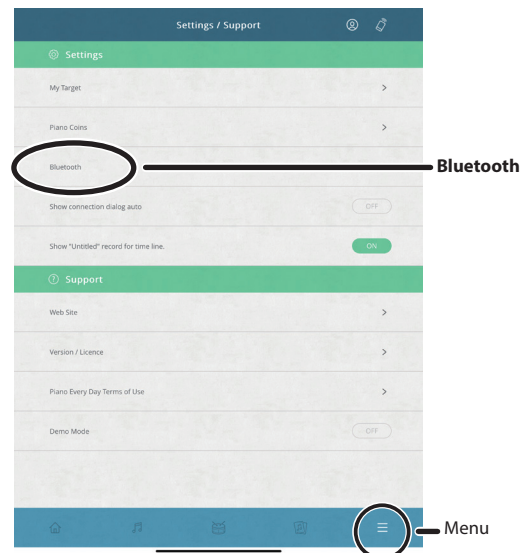

The screen of your mobile device shows "FP-90X MIDI" or "FP-60X MIDI."

4. Tap either "FP-90X MIDI" or "FP-60X MIDI" depending on the unit that you're using.

The piano and mobile device are paired. When pairing is completed, a display like the following appears.

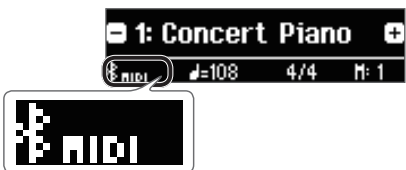
Mobile device	"FP-90X MIDI" or "FP-60X MIDI" are added in the "My Devices" field
Piano	The "MIDI" is shown beside the Bluetooth symbol 

Settings are now complete.

If Pairing Does Not Succeed in "Using the Piano with an App"

If pairing is not successful in "Using the Piano with an App" (p. 14), try steps 1–4 below.

1 Make sure that the piano's Bluetooth function is "On."

1. Press the piano's [Function] button.
2. Use the [◀] [▶] buttons to select "Bluetooth."
3. Press the [Function] (Enter) button.
The Bluetooth setting screen appears.
4. Use the [◀] [▶] buttons to select "Bluetooth On/Off," and then use the [-] [+] buttons to turn it "On."
The piano's Bluetooth function turns on.
5. Press the [Function] button.
You exit function mode.

2 Exit all apps on your mobile device.

Closing the app

1. Double-click the home button, and swipe up on the app screen.

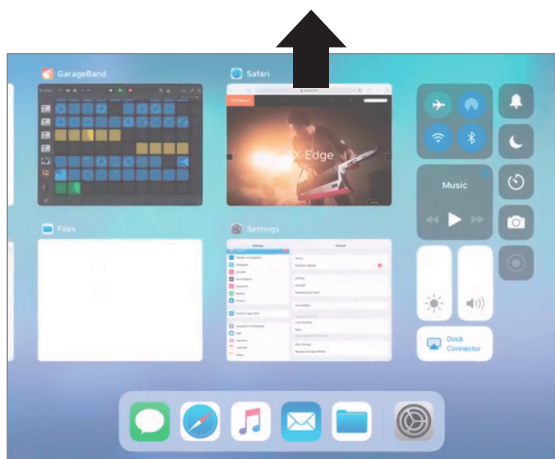

3 If already paired, cancel pairing, and turn off the Bluetooth function.

Clearing the pairing

1. In the mobile device's screen, tap the "i" located beside "Connected," and tap "Forget This Device."

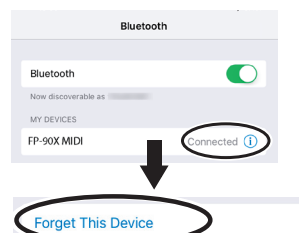

2. Turn the Bluetooth switch off.

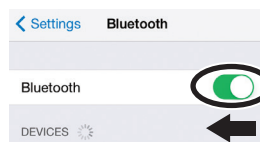

4 Perform the pairing procedure of p. 14 from step 1.

MEMO

If checking these points does not solve the problem, please refer to the Roland support website.

<https://www.roland.com/support/>

Advanced Operation

Playing Various Tones

Selecting Your Preferred Performance Environment (My Stage)

"My Stage" is a function that lets you select your preferred piano and performance environment while at home. This function reproduces the sound and resonance that you would experience when playing in locations such as a concert hall, church, or rehearsal studio on a grand piano that's ideally matched for that location.

* The My Stage settings consist of the combination of "grand piano tone," "ambience (acoustics) type," and "ambience (acoustics) depth."

No.	FP-90X	FP-60X
1	Piano Recital	Piano Recital
2	At Hall Stage	At Hall Stage
3	Lakeside Studio	Lakeside Studio
4	Impressionists	Heritage Hall
5	Heritage Hall	Lounge Concert
6	Lounge Concert	Church Concert
7	Church Concert	Jazz Club
8	Jazz Club	Recording Studio
9	Medieval Salon	
10	Recording Studio	
11	Trad Opera House	
12	East Coast Hall	

1. Press the [My Stage] button to make it light.
2. Use the [-][+] buttons to select your preferred performance environment.



Play the keyboard to perform with the selected "My Stage" settings.

MEMO

You can press the [▶] button to hear a "My Stage" demo performance.

3. To exit the My Stage function, press the [My Stage] button to make it go dark.

Selecting the Type and Depth of Ambience

You can add acoustical ambience that is characteristic of a performance in a concert hall or cathedral. By changing the "Ambience Type" you can simulate the acoustics of a piano being played in a variety of locations.

When using headphones, the FP-60X lets you apply a headphone 3D ambience effect. The FP-90X features headphone acoustic projection technology that lets you experience a more three-dimensional sound field.

FP-90X

1. Press the [Ambience] button to make it light.
The ambience screen appears.



2. Use the [◀] [▶] buttons to select the "Ambience Type."
3. Use the [-][+] buttons to specify the "Ambience Depth."
4. When you are finished making settings, press the [Ambience] button once again to make it go dark.

FP-60X

1. Press the [Ambience] button to make it light.
The ambience edit screen appears.

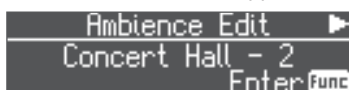

2. Press the [Function] (Enter) button.

The ambience screen appears.



3. Use the [◀] [▶] buttons to select the "Ambience Type."
4. Use the [-][+] buttons to specify the "Ambience Depth."
If you want to change the headphone 3D ambience, proceed as follows.
5. Press the [Exit] button to return to the ambience edit screen.
6. Use the [▶] button to select "Headphones 3D Ambience," and then use the [-][+] buttons to specify the "On/Off" setting.
7. When you are finished making settings, press the [Ambience] button once again to make it go dark.

Ambience Type	Selects the ambience that is characteristic of playing a piano in various locations.	
	* If you're using the FP-90X, you can choose the type of ambience when a tone of the PureAcoustic Piano sound engine is selected (p. 31).	
	FP-90X	Studio, Lounge, Concert Hall, Wooden Hall, Stone Hall, Cathedral
	FP-60X	Studio, Lounge, Concert Hall, Cathedral
Ambience Depth	Adjusts the depth of the sound's ambience. Higher settings produce deeper ambience, and lower settings produce less ambience.	
	* The reverberation effect is not applied to audio files.	
	0-10	
Headphones 3D Ambience	You can apply a Headphones 3D Ambience effect that creates the impression that the sound is being heard from the piano itself even when you're using headphones.	
	* The effect is applied if "Concert Hall" is selected as the ambience type and a tone of the "SuperNATURAL Piano sound engine" is selected (p. 31).	
	* The reverberation effect is not applied to audio files.	
	Off, On (default value: On)	

MEMO

If you store your preferred My Stage settings as a "registration," you'll be able to recall them any time you like (p. 23).

Practicing with the Metronome

You can practice while hearing a metronome.

1. Press the [Metronome] button to make it light.
The metronome sounds.

MEMO

If a song is playing, the metronome sounds at the tempo and time signature of that song.

2. To change the tempo, use the Tempo [Slow] [Fast] buttons.

Tempo range	10-500
-------------	--------

3. To stop the metronome, press the [Metronome] button once again to make it go dark.

Changing the Settings for Metronome

Change the following settings while the [Metronome] button is on.

1. Use the [◀] [▶] buttons to access the parameter that you want to edit.
2. Use the [-][+] buttons to specify the value.

Tempo Coach	Uses the Tempo Coach function (p. 17).
Metronome Volume	Changing the metronome's volume
	Off, 1–10 (default value: 5)
Metronome Tone	Changes the tone of the metronome.
	Click, Electronic, Voice (Japanese), Voice (English) (default value: Click)
Beat	Changes the time signature of the metronome.
	2/2, 3/2, 2/4, 3/4, 4/4, 5/4, 6/4, 7/4, 3/8, 6/8, 8/8, 9/8, 12/8 (default value: 4/4)
Metronome Down Beat	Sounds a downbeat.
	Off, On (default value: On)
Metronome Pattern	Changes the pattern of the metronome.
	Off, Eighth note, Eighth-note triplet, Shuffle, Sixteenth note, Quarter-note triplet, Quarter note, Dotted eighth (default value: Off)

Sounding a Click Tone in Synchronization with the Song Tempo (Auto Tempo)

The auto tempo function sounds a click tone (metronome sound) in synchronization with the tempo of an audio song being input from an external source. This is very convenient when you want to practice along with an audio song while also hearing a click.

- Even if you don't know the tempo of the original song, the tempo is automatically detected and the click is synchronized.
- Even if the original song does not contain drums or other rhythm instruments, the tempo can be detected, and the click used instead of a rhythm performance.

The auto tempo function can be used with a song that is being played in the following three situations.

- A song played back by a **Bluetooth**-connected mobile device (p. 13)
- A song played back by an audio player connected to the Input Stereo jack (p. 6)
- A song played back by player software on a computer that's connected to the USB Computer port (p. 6)

In advance, connect your mobile device or computer to the piano using the appropriate connection for your situation (via **Bluetooth**, an audio cable, or a USB cable).

1. **Play back a song from your external device.**
The song is heard from the piano's speakers.
2. **While the song plays, long-press the [Metronome] button.**
Auto tempo turns on, and a click tone is heard in synchronization with the tempo of the song.
Go ahead and perform in time with the song and the click tone.

MEMO

In the middle of the song, you can once again long-press the [Metronome] button and update the tempo as many times as you like.

3. **To stop using auto tempo, press the [Metronome] button to make it go dark.**

Detecting the Tempo of Your Own Performance (Tempo Coach)

By using the tempo coach function, you can ascertain the tempo of the current keyboard performance.

You can operate the tempo coach setting when the [Metronome] button is on.

1. Use the [◀] [▶] buttons to make the display indicate "Tempo Coach."

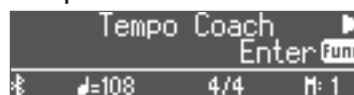

2. Press the [Function] (Enter) button.

The tempo coach screen appears, and the metronome stops.



3. Play a song on the piano.

The tempo of the played song is detected, and the performance tempo is displayed.

MEMO

When you play a song, the tempo can be detected more accurately if you play using both hands than if you play using one hand.

4. Press the [Exit] button.

You exit the tempo coach screen.

MEMO

By pressing the [Metronome] button you can sound the metronome at the detected tempo.

Dividing the Keyboard for Two People (Twin Piano)

You can divide the keyboard into left and right areas so that two people can play the same range of pitches. One person can play a model performance, and the other person can practice along with that model performance. You can also change the way (Mode) in which notes are sounded in Twin Piano.

* If you select some tones, it sounds different than usual.

1. Press the [Function] button, and then use the [◀] [▶] buttons to select "Twin Piano."
2. Use the [-][+] buttons to turn twin piano "On."
3. Press the [Exit] button.

The Twin Piano screen appears.

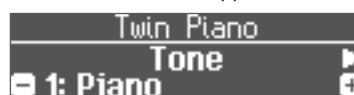

4. Use the [◀] [▶] buttons to access the parameter that you want to edit.
5. Use the [-][+] buttons to specify the value.

Tone	Selects the tone used when playing Twin Piano.	
Mode	Pair	The sound will be heard from the right as you play toward the right of the keyboard, and from the left as you play toward the left.
	Individual	Notes played in the right area will be heard from the right speaker, and notes played in the left area will be heard from the left speaker.

6. When you are finished using Twin Piano, press the [Function] button to return to the "Twin Piano (On/Off screen)," and return it to "Off."
7. Press the [Exit] button several times to exit function mode.

English

日本語

Deutsch

Français

Italiano

Español

Português

Nederlands

简体中文

Recording Your Performance

It's easy to record your own performances. You can play back a recorded performance to check your playing, or play along with a recorded performance.

Type of recording

SMF recording	<ul style="list-style-type: none"> The performance is recorded as MIDI data. SMF format 0
Audio recording	<ul style="list-style-type: none"> Your performance will be recorded as audio data. WAV format, 44.1 kHz, 16-bit linear * In order to use audio recording, you must connect a USB flash drive (sold separately) to the USB Memory port.

SMF Recording

Recording a New Song

Preparing to Record

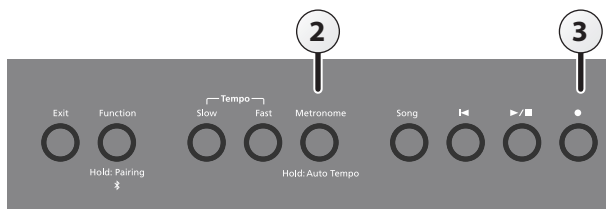

1. Select the tone that you want to play (p. 8).
2. You can sound the metronome if you like (p. 16).
You can specify the tempo and time signature of the metronome.

MEMO

The metronome's tempo and time signature settings are stored in the song, so that the metronome plays correctly even when you play back the song.

3. Press the [●] button.

The [●] button lights, the [▶/■] button blinks, and the unit enters record-standby mode.

If you decide to cancel recording, press the [●] button once again.

Starting your recording and saving it

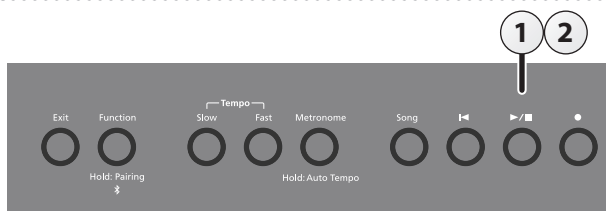

1. Press the [▶/■] button.
Recording starts after a one-measure count sounds.
When recording starts, the [●] button and [▶/■] button light.

MEMO

You can also start recording by playing the keyboard. In this case, a count is not sounded.

2. Press the [▶/■] button.
Recording stops, and your performance is automatically saved.

MEMO

- You can change the name of the song (p. 19).
- You can delete the song (p. 20).

NOTE

Never turn off the power while "Saving..." is shown in the display.

Listening to the recorded performance

After you record, the newly recorded song is selected.

1. Press the [▶/■] button.

Playback starts from the beginning of your recorded performance.

Recording Audio

If you audio-record your performance, you'll be able to listen to it on your computer or audio player, use it to create a music CD, or publish it on the Internet.

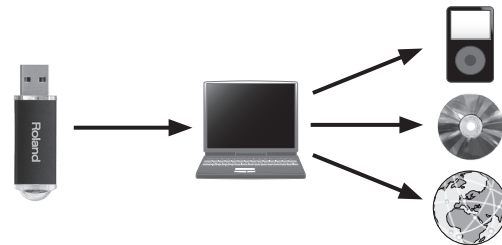

Preparing to Record

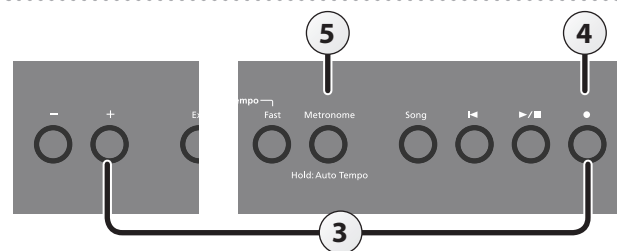

1. Connect your USB flash drive to the USB Memory port (p. 6).

* Audio data can't be stored in internal memory.

2. Select the tone that you want to play (p. 8).
3. Hold down the [●] button and press the [+] button to select "Audio."

MEMO

You can also specify this via the Function mode "Recording Mode" setting (p. 27).

4. Press the [●] button.

The [●] button lights, the [▶/■] button blinks, and the unit enters record-standby mode.

If you decide to cancel recording, press the [●] button once again.

NOTE

Never turn off the power or disconnect the USB flash drive during recording.

5. You can sound the metronome if you like (p. 16).

Starting your recording and saving it

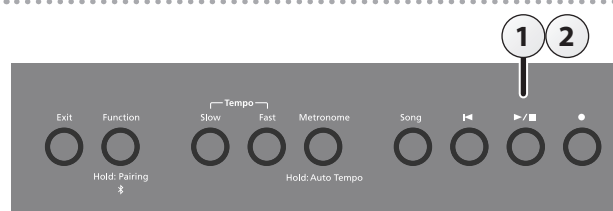

1. Press the [▶/■] button.
Recording starts.
When recording starts, the [●] button and [▶/■] button light.
2. Press the [▶/■] button.
Recording stops, and your performance is automatically saved.

MEMO

- You can change the name of the song (p. 19).
- You can delete the song (p. 20).

Listening to the recorded performance

After you record, the newly recorded song is selected.

1. Press the [▶/■] button.
Playback starts from the beginning of your recorded performance.

Converting an SMF-recorded song to audio

A song recorded as SMF can be re-recorded as audio so that you can play it back on your computer.

1. Select the song that you want to convert to audio (p. 11).
2. Prepare for audio recording ("Preparing to Record" (p. 18)).
 1. Connect your USB flash drive.
 2. Hold down the [●] button and use the [+] button to select "Audio."
 3. Press the [●] button.
3. Press the cursor [▶] button to select the song of step 1.
4. Press the [▶/■] button to start audio recording ("Starting your recording and saving it" (p. 19)).

- * During recording, any sounds that you produce by playing the keyboard or that are input to the unit via the Mic Input jack, the USB port, the Input Stereo jack, or Bluetooth audio are included in the audio that is recorded during this conversion.
- * Depending on the SMF, it might not be possible to convert it into the identical audio as when the song was recorded.

Convenient Functions for Song Playback

When playing back a song, you can use the following functions.

Play all songs in the selected category (All Song Play)	Hold down the [Song] button and press the [▶/■] button.
Change the song tempo	Press the Tempo [Slow] [Fast] button.
Play back the song at a constant tempo (Tempo Mute)	Hold down the [▶/■] button and press the Tempo [Slow] or [Fast] button. To clear the tempo mute function, hold down the [▶/■] button once again and press the Tempo [Slow] or [Fast] button.
Sound a count-in (*1)	Hold down the [Metronome] button and press the [▶/■] button.

*1 A series of sounds rhythmically played to indicate the tempo before a song starts is called a "count-in." If you sound a count-in, it will be easier for you to synchronize your own performance to the tempo of the playback
You can change the number of measures that are sounded as a count (p. 27).

Renaming a Song (Rename Song)

Here's how to rename a previously-saved song.

1. Press the [Function] button, and then use the [◀] [▶] buttons to select "Rename Song."

2. Press the [Function] (Enter) button.

The Rename Song screen appears.

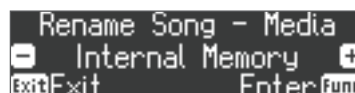

3. Use the [-] [+] buttons to select the media that contains the song that you want to rename.

4. Press the [Function] (Enter) button.

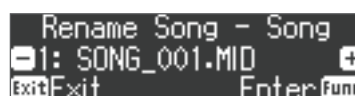

5. Use the [-] [+] buttons to select the song that you want to rename, and then press the [Function] (Enter) button.

6. Rename the song.

Button	Operation
[◀] [▶] button	Select the character to change.
[-] [+] buttons	Change the character.
Insert one character	Press the [▶/■] button.
Delete one character	Press the [●] button.

If you decide to cancel, press the [Exit] (Exit) button.

7. Press the [Function] (Enter) button.

A confirmation message appears.

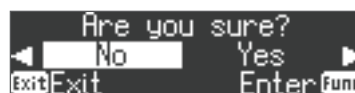

If you decide to cancel, press the [Exit] (Exit) button.

8. Use the [▶] button to select "Yes," and then press the [Function] (Enter) button.

The song is renamed.

NOTE

Never turn off the power or remove the USB flash drives while the screen indicates "Executing..."

9. Press the [Exit] button several times to exit Function mode.

Copying a Saved Song (Copy Song)

Songs that have been saved in internal memory can be copied to USB flash drive. Alternatively, songs stored on a USB flash drive can be copied to internal memory.

- * Audio files cannot be copied.
- * If a USB flash drive is not connected, you won't be able to perform this operation.

1. Press the [Function] button, and then use the [◀] [▶] buttons to select "Copy Song."

2. Press the [Function] (Enter) button.

The Copy Song screen appears.

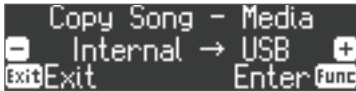

3. Use the [-] [+] buttons to select the copy-source and copy destination memory locations.

4. Press the [Function] (Enter) button.

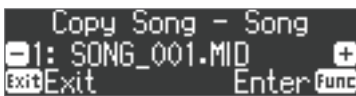

5. Use the [-] [+] buttons to select the song that you want to copy.

If you decide to cancel, press the [Exit] (Exit) button.

6. Press the [Function] (Enter) button.

The copy is executed.

NOTE

Never turn off the power or remove the USB flash drives while the screen indicates "Executing..."

MEMO

If a song with the same file name has already been saved, the confirmation message "Overwrite?" appears. To overwrite the song, use the [▶] button to select "Yes," and then press the [Function] (Enter) button.

7. Press the [Exit] button several times to exit Function mode.

Deleting a Saved Song (Delete Song)

Here's how to delete a song that you saved on an internal memory or USB flash drive.

MEMO

- If you want to delete all songs that have been saved to internal memory or USB flash drive, initialize the memory (p. 25).
- If you want to delete a song on the USB flash drive, connect your USB flash drive to the USB Memory port before you continue.

1. Press the [Function] button, and then use the [◀] [▶] buttons to select "Delete Song."

2. Press the [Function] (Enter) button.

The Delete Song screen appears.

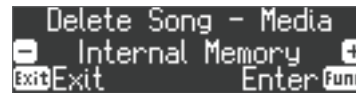

3. Use the [-] [+] buttons to select the memory location that contains the song you want to delete.

4. Press the [Function] (Enter) button.

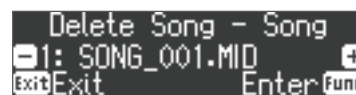

5. Use the [-] [+] buttons to select the song that you want to delete.

6. Press the [Function] (Enter) button.

A confirmation message appears.

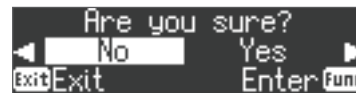

If you decide to cancel, press the [Exit] (Exit) button.

7. Use the [▶] button to select "Yes," and then press the [Function] (Enter) button.

The deletion is executed.

NOTE

Never turn off the power or remove the USB flash drives while the screen indicates "Executing..."

8. Press the [Exit] button several times to exit Function mode.

MEMO

You can also delete a song by holding down the [●] button and pressing the [Exit] button.

Personalizing Your Piano Sound (Piano Designer)

What is Piano Designer?

This unit allows you to personalize your piano sound by adjusting various factors that affect the sound, such as the piano's strings, the resonance produced using the pedals, and the sound of the hammers striking the strings. This function is called "Piano Designer."

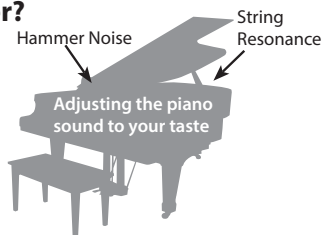

MEMO

- The Piano Designer function can be used to personalize the sound only with "PureAcoustic Piano sound engine" tones on the FP-90X, and only with "SuperNATURAL Piano sound engine" tones on the FP-60X.
- The settings are saved for each tone.

1. Press the [Function] button, and then use the [◀] [▶] buttons to select "Piano Designer."

2. Press the [Function] (Enter) button.

The Piano Designer screen appears.

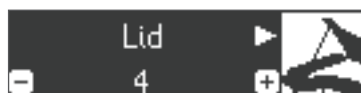

3. Use the [◀] [▶] buttons to select the item that you want to edit.

4. Use the [-] [+] buttons to adjust the value.

5. When you're finished using Piano Designer, press the [Exit] button.

A confirmation message appears.



If you decide to cancel, press the [Exit] (Exit) button.

6. Use the [▶] button to select "Yes," and then press the [Function] (Enter) button.

The Piano Designer settings are saved.

MEMO

If you decide to exit without saving the settings, use the [◀] button to select "No" and then press the [Function] (Enter) button.

Piano designer parameters

* The parameters that can be edited differ between the FP-90X and the FP-60X.

Parameter	90X	60X	Value	Explanation
Lid	●	●	0-6	Adjusts the extent to which the lid of the grand piano is open. The sound will become more mellow as you close the lid of the piano in the screen. The sound will become brighter as you open the lid of the piano in the screen.
Key Off Noise	●	-	Off, 1-10	Adjusts the action noise that is heard when you release a key. Higher settings produce a louder action noise.
Hammer Noise	●	-	-5-0+5	Adjusts the sound produced when the hammer of an acoustic piano strikes the string. Higher settings will produce a louder sound of the hammer striking the string.
Duplex Scale	●	-	Off, 1-10	Adjusts the sympathetic vibrations of an acoustic piano's Duplex Scale. Higher settings will make the sympathetic vibration louder.

Parameter	90X	60X	Value	Explanation
Full Scale String Res.	●	-	Off, 1-10	Adjusts the resonant sound of an acoustic piano (the sound produced by the strings of previously-pressed keys vibrating in sympathy with newly played notes, or the sound of other strings vibrating in sympathy with the notes you play while pressing the damper pedal). Higher settings produce louder sympathetic resonance.
String Resonance	-	●	Off, 1-10	This adjusts the string resonance of the acoustic piano sound (the sympathetic vibrations of strings for previously played notes that occur when you play another note). Higher settings will make the sympathetic vibration louder.
Damper Resonance	-	●	Off, 1-10	Adjusts the overall resonance of the acoustic piano when its damper pedal is pressed (the sound of other strings vibrating in sympathy when you press the damper pedal, and the resonance of the entire instrument). Higher settings make the sympathetic vibration louder.
Key Off Resonance	●	●	Off, 1-10	Adjusts the resonance of the subtle sounds that occur when a key of an acoustic piano is released. A higher value produces a larger tonal change during the decay.
Cabinet Resonance	●	-	Off, 1-10	Adjusts the body resonance of the grand piano itself. Higher values will produce a larger body resonance.
Soundboard Type	●	-	1-5	Selects how the soundboard of the acoustic piano will resonate. You can choose from five different types of resonance.
Damper Noise	●	-	Off, 1-10	Adjusts the damper noise of the acoustic piano sound (the sound of the damper releasing the strings when you press the damper pedal).
Soft Pedal	●	-	1-10	Adjusts the depth of the effect that occurs when you press the soft pedal. With higher values, the change will be greater.
Single Note Tuning	●	●	-50-0+50	Specifies a method of tuning (stretch tuning) that is distinctive to the piano, in which the high register is tuned slightly sharper and the low register is tuned slightly flatter.
Single Note Volume	●	●	-50-0	Adjusts the volume of each key. Higher settings increase the volume.
Single Note Character	●	●	-5-0+5	Adjusts the tonal character of each key. Higher settings produce a harder tone, and lower settings produce a softer tone.
Reset Setting	<p>Here's how the Piano Designer settings of the selected sound can be returned to their factory-set state.</p> <ol style="list-style-type: none"> Press the [Function] (Enter) button. If you decide to cancel, press the [Exit] button. Use the [▶] button to select "Yes," and then press the [Function] (Enter) button. The settings return to their factory-set state. 			

88-key settings

- Select the Single Note Tuning, Single Note Volume, or Single Note Character, and press the [Function] (Enter) button.
- Play the key that you want to edit, and use the [-] [+] buttons to adjust the settings for that key.

MEMO

You can use the [◀] [▶] buttons to move to a different 88-key parameter.

- Press the [Exit] button to return to the previous screen.

What is the duplex scale?

The Duplex Scale is a system of sympathetically vibrating strings sometimes included in grand pianos.

These sympathetically vibrating strings are not struck directly with hammers, but sound by vibrating in sympathy with the vibrations of other strings. By resonating with the overtones, these strings add richness and brilliance to the sound. These sympathetic strings are added only to the high register above approximately C4. Since they do not have a damper (a mechanism that stops them from sounding), they will continue sounding even after you play a note and then release it to stop the sound of the string that was actually struck.

Using the Microphone

You can connect a dynamic microphone (sold separately) to the Mic Input jack and sing while playing.

Connecting a Microphone

Here's how to connect a microphone to the Mic Input jack.

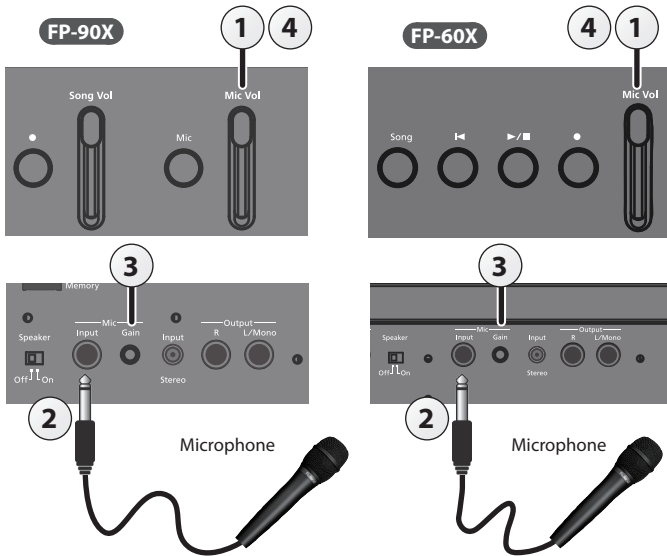

1. Move the [Mic Vol.] slider all the way down to minimize the volume.
2. Connect the microphone to the Mic Input jack.
The microphone input will turn on.
3. If the sound of the mic is too weak or is distorted, turn the rear panel Mic [Gain] knob to adjust the volume of the mic.
4. Move the [Mic Vol.] slider to adjust the volume of the mic.

* If the volume is excessive, you may hear noise from the speakers.

MEMO
You can adjust the volume balance as with an audio mixer.

FP-90X

FP-60X

Applying an Effect to the Mic (Mic Effects)

Here's how to apply an effect to the sound of the mic.

FP-90X

1. Press the [Mic] button.

The Mic Effects screen appears.



2. Use the [◀] [▶] buttons to select the effect that you want to apply.
3. Use the [-] [+] buttons to switch the setting on/off.

FP-60X

1. Press the [Function] button to make it light.

2. Use the [◀] [▶] buttons to select "Mic Effects."

3. Press the [Function] (Enter) button.

The Mic Effects screen appears.



4. Use the [◀] [▶] buttons to select the effect that you want to apply.
5. Use the [-] [+] buttons to switch the setting on/off.

Adjusting the Mic Effect

Here's how to adjust how the effect is applied.

1. In the Mic Effects screen, press the [▶] button.
2. Adjust the effect.

Indication	Value	Explanation
[◀] [▶] button	[-] [+] buttons	
Compressor Type	Soft, Normal, Hard	Specifies the amount of the effect that restrains the level in response to the audio input. Soft, Normal, and Hard settings produce a progressively greater effect.
Doubling Type	One Voice, Two Voice	Produces an effect as though a singing voice is layered multiple times.
Doubling Width	Light, Normal, Deep	Specifies the pitch difference between the layered voice and the original sound. Light, Normal, and Deep settings produce progressively greater pitch difference.
Doubling Level	0-10	Specifies the volume of the doubling effect.
Echo Type	1-7	Selects the type of echo.
Echo Level	0-10	Higher values produce greater reverberance.

Saving Performance Settings (Registrations)

What Is a Registration?

Tone settings and performance settings such as Dual Play or Split Play can be saved as a "registration" and recalled whenever you like.

This unit has five registration buttons ([1]–[5]), and you can save nine different registrations under each button. This means that you can save as many as 45 registrations.

An entire group of 45 registrations is called a "Registration Set."

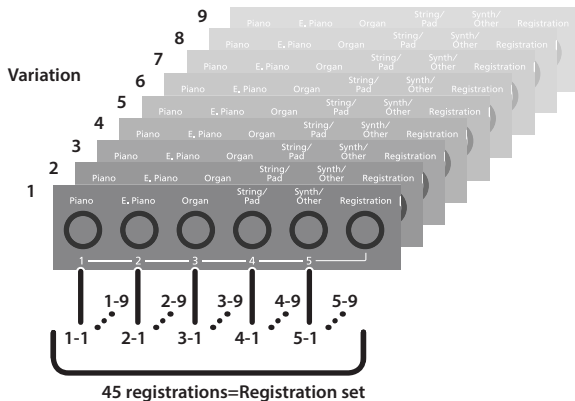

MEMO

- For more about the settings saved in a registration, refer to "Saved Settings" (p. 30).
- You can save registration sets to a USB flash drive (sold separately; p. 6).

Recalling a Registration

Here's how to recall settings that you've saved in a registration.

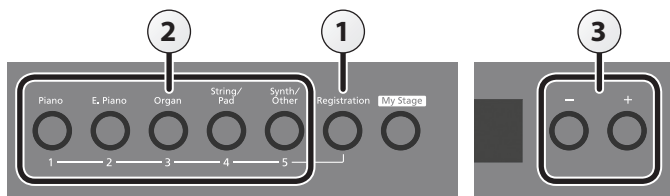

1. Press the [Registration] button.

The first time you press the [Registration] button after turning on the power, a screen like the following will appear.



2. Press a number button ([1] to [5]) to choose the location where the desired registration is saved.



3. Press the [-] [+] buttons to select the registration variation.

The settings change accordingly.

MEMO

- You can also use a pedal to recall registrations (p. 28).
- You can reload registration sets that you've saved to a USB flash drive (p. 24).

4. Press the [Exit] button.

Saving Current Settings into a Registration

Here's how to save the performance settings to a registration.

NOTE

When you save a registration into a location, it will overwrite any registration already stored at that location.

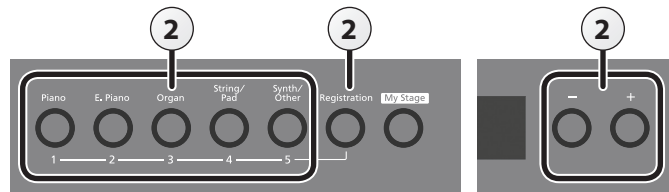

1. Make the desired performance settings.

2. Hold down the [Registration] button and press one of the [1]–[5] buttons, then press the [-] [+] buttons to which you want to assign the settings.

When you release the [Registration] button, you will see a screen like the one shown below.

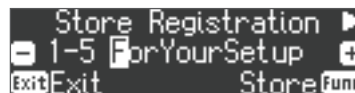

3. Rename the registration.

Button	Operation
[◀] [▶] button	Select the character to change.
[-] [+] buttons	Change the character.
Insert one character	Press the [▶/■] button.
Delete one character	Press the [●] button.

If you decide to cancel, press the [Exit] (Exit) button.

4. Press the [Function] (Store) button.

The performance settings are saved. The [Registration] button stops blinking and lights up solid.

NOTE

Do not turn off the power while "Executing..." is displayed.

5. Press the [Exit] button.

MEMO

You can reset all registrations to their factory defaults. For details, refer to "Returning the Factory Settings (Factory Reset)" (p. 25).

English

日本語

Deutsch

Français

Italiano

Español

Português

Nederlands

简体中文

Saving a Registration Set (Registration Set Export)

Here's how the registration set that's saved in this unit can be saved to a USB flash drive.

- * If you're saving to a USB flash drive, connect your USB flash drive to the USB Memory port before proceeding.

1. Press the [Function] button.
2. Use the [◀] [▶] buttons to select "Reg. Set Export."
3. Press the [Function] (Enter) button.

The Reg. Set Export screen appears.

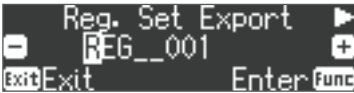

4. Renaming the registration set.

Button	Operation
[◀] [▶] button	Select the character to change.
[−] [+] buttons	Change the character.
Insert one character	Press the [▶/■] button.
Delete one character	Press the [●] button.

If you decide to cancel, press the [Exit] (Exit) button.

5. Press the [Function] (Enter) button.

The registration set is saved.

NOTE

Never turn off the power or remove the USB flash drives while the screen indicates "Executing..."

6. Press the [Exit] button several times to exit Function mode.

Loading a Saved Registration Set (Registration Set Import)

Here's how a registration set saved on a USB flash drive can be loaded into the registrations of this unit.

- * If you want to load a registration set from a USB flash drive, connect your USB flash drive to the USB Memory port before proceeding.

NOTE

Note that when you load a registration set, it will overwrite (and erase) all of the registrations already in registration memory. If you wish to retain your existing registrations, save them to a USB flash drive.

1. Press the [Function] button.
2. Use the [◀] [▶] buttons to select "Reg. Set Import."
3. Press the [Function] (Enter) button.

The Reg. Set Import screen appears.

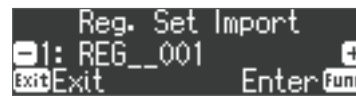

4. Use the [−] [+] buttons to select the registration set you want to load.

5. Press the [Function] (Enter) button.

A confirmation message appears.

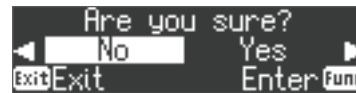

If you decide to cancel, press the [Exit] (Exit) button.

6. Use the [▶] button to select "Yes," and then press the [Function] (Enter) button.

The registration set will be loaded.

NOTE

Never turn off the power or remove the USB flash drives while the screen indicates "Executing..."

7. Press the [Exit] button several times to exit Function mode.

Convenient Functions

Initializing the Memory (Format Media)

You can completely erase all data that were saved in internal memory or on a USB flash drive.

NOTE

- All data saved in internal memory or on the USB flash drive will be erased when you initialize the media.
- If you want settings other than the internal memory and USB flash drive songs to be returned to their factory-set state, execute a Factory Reset (p. 25).

1. If you want to initialize a USB flash drive, connect the USB flash drive to the USB Memory port (p. 6).
2. Press the [Function] button, and then use the [◀] [▶] buttons to select "Format Media."
3. Press the [Function] (Enter) button.

The Format Media screen appears.

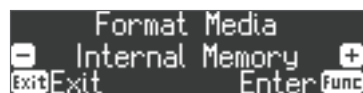

If you decide to cancel, press the [Exit] (Exit) button.

4. Use the [-] [+] buttons to select the media that you want to format.
5. Press the [Function] (Enter) button.

A confirmation message appears.

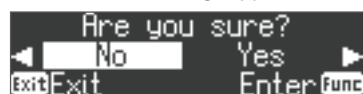

If you decide to cancel, press the [Exit] (Exit) button.

6. Use the [▶] button to select "Yes," and then press the [Function] (Enter) button.

The memory is formatted.

NOTE

Never turn off the power or remove the USB flash drives while the screen indicates "Executing..."

7. Press the [Exit] button several times to exit Function mode.

Returning to the Factory Settings (Factory Reset)

Here's how to restore all registrations and internally saved settings to the factory-set condition. This function is called "Factory Reset."

NOTE

A factory reset returns all of your saved settings to their factory values.

MEMO

Executing this function does not erase the songs in internal memory or on a USB flash drive (sold separately). If you want to erase all songs from internal memory or from a USB flash drive, refer to "Reformatting Memory (Format Media)" (p. 25).

1. Press the [Function] button, and then press the [◀] [▶] buttons to select "Factory Reset."
2. Press the [Function] (Enter) button.

A confirmation message appears.

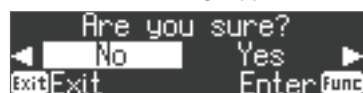

If you decide to cancel, press the [Exit] (Exit) button.

3. Use the [▶] button to select "Yes," and then press the [Function] (Enter) button.

The memory is reset to its factory values.

NOTE

Never turn off the power or remove the USB flash drives while the screen indicates "Executing..."

4. Turn the power off, then on again (p. 5).

Retaining Settings After Power-Off (Memory Backup)

Temperament settings, equalizer settings, and other settings are reset to their default values when this unit is turned off.

You can automatically restore the desired settings if you save them in internal memory.

MEMO

For a list of settings saved by Memory Backup, see "Saved Settings" (p. 30).

1. Press the [Function] button, and then use the [◀] [▶] buttons to select "Memory Backup."
2. Press the [Function] (Enter) button.

A confirmation message appears.

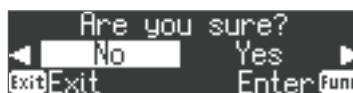

If you decide to cancel, press the [Exit] (Exit) button.

3. Use the [▶] button to select "Yes," and then press the [Function] (Enter) button.

Memory Backup will be carried out.

NOTE

Never turn off the power or remove the USB flash drives while the screen indicates "Executing..."

4. Press the [Exit] button several times to exit Function mode.

Using USB

This unit can be USB-connected to a computer or similar device so that performance data (USB MIDI) and audio signals (USB Audio) can be transferred, allowing you to do the following things.

- A performance played on this unit can be recorded as MIDI data into sequencer software (sold separately).
- MIDI data sent from sequencer software can be played by this unit.
- A performance played on this unit can be recorded as an audio signal into sequencer software.
- Music played back on your computer can be heard through the speakers of this unit.

MEMO

Since this unit's USB functionality uses the default USB driver of your computer, you don't need to install a dedicated USB driver.

Various Settings (Function Mode)

1. Press the [Function] button.
The [Function] button lights, and the unit is in Function mode.
2. Press the [◀] [▶] buttons to select the setting you want to change.
3. Press the [-] [+] buttons to adjust the value.
4. Press the [Exit] button to finish.

* Depending on the item you select, an additional screen may be displayed.

Indication [◀] [▶] buttons	Parameter [-] [+] buttons	Explanation
Bluetooth	You can use a smartphone app via Bluetooth , or play back audio from your smartphone. Refer to "Connecting the Piano and a Mobile Device via Bluetooth " (p. 12).	
Key Touch	Adjusting the Keyboard Response (Key Touch)	
	The way in which the keyboard responds to your playing strength can be adjusted to your personal taste.	
	Fix, 1–100	Higher values will make the keyboard feel heavier. If you've specified "Fix," notes will sound at the same volume regardless of how strongly you play the keyboard.
	Matching the Pitch with Other Instruments (Master Tuning)	
Master Tuning	When playing ensemble with other instruments and in other such instances, you can match the standard pitch to another instrument. The reference pitch generally refers to the pitch of the note that's played when you finger the middle A key. For a cleaner ensemble sound while performing with one or more other instruments, ensure that each instrument's standard pitch is in tune with that of the other instruments.	
	415.3 Hz–440.0 Hz–466.2 Hz	
Temperament	Changing the Tuning Method (Temperament)	
	You can play classical styles such as Baroque using historic temperaments (tuning methods). Most modern songs are composed and played with the assumption that equal temperament (the most common tuning in use today) will be used, but when classical music was composed, there were a wide variety of other tuning systems in existence. Playing a composition with its original tuning lets you enjoy the sonorities of the chords that the composer originally intended.	
	Equal	This temperament divides the octave into twelve equal steps. It is the temperament that is most commonly used on today's pianos. Every interval has the same slight amount of dissonance.
	Just Major Just Minor	In these temperaments, the primary triads are perfectly consonant. It is unsuited to playing melodies and cannot be transposed, but is capable of beautiful sonorities. The Just tunings differ from major and minor keys.
	Pythagorean	This tuning, devised by the philosopher Pythagoras, eliminates dissonance in fourths and fifths. Although third chord is slightly dissonant, this tuning is suitable for songs that have a simple melody.
	Kirnberger I	As in the Just temperaments, the primary triads are consonant in this tuning. Beautiful sonorities are obtained when playing songs that are written in keys appropriate for this tuning.
	Kirnberger II	This is a revision of Kirnberger I that reduces the limitations on the usable keys.
	Kirnberger III	This is an improvement of the Meantone and Just tunings that provides a high degree of freedom of modulation. Performances are possible in all keys. Since the resonance differs depending on the key, chords played in this temperament resonate in diverse ways when compared to equal temperament.
	Meantone	This temperament slightly narrows the fifth relative to Just temperaments. While the Just temperaments contains two types of whole tone (major whole tone and minor whole tone), meantone temperament uses only one type of whole tone (mean whole tone). Transposition within a limited range of keys is possible.
	Werckmeister	This temperament consists of eight perfect fifths and four narrowed fifths. Performance in all keys is possible. Since different keys produce different sonorities, chords will resonate in diverse ways when compared to equal temperament (Werckmeister I (III)).
	Arabic	This scale is suitable for Arabic music.
Temperament Key	Specifying a Song's Tonic (Temperament Key)	
	When playing with tuning other than equal temperament, you need to specify the temperament key for tuning the song to be performed (that is, the note that corresponds to C for a major key or to A for a minor key). If you choose an equal temperament, there's no need to select a temperament key.	
	C–B	
Piano Designer	Lets you personalize your piano sound by adjusting various elements that affect the sound: the piano's physical strings, the resonances produced by the pedals, the sound of hammers striking the strings, and more. Refer to "Personalizing Your Piano Sound (Piano Designer)" (p. 21).	
Hammer Response	Off, 1–10	Adjusts the time from when you play the key until the piano sound is heard. Higher values produce a greater delay.
Twin Piano	You can divide the keyboard into left and right areas so that two people can play the same range of pitches. Refer to "Dividing the Keyboard for Two People (Twin Piano)" (p. 17).	
Equalizer	Editing the Equalizer Settings	
	You can use the equalizer to modify the tone color by boosting or reducing just the low-frequency or high-frequency range of the sound. To edit the equalizer settings, use the [◀] [▶] buttons to select "Equalizer," and then press the [Function] (Enter) button.	
	EQ Low Freq	20–400 (Hz) Frequency point in the low-frequency range. This changes the level at and under the specified bandwidth.
	EQ Mid Freq	200–8000 (Hz) Frequency point in the mid-frequency range. This changes the level of the specified bandwidth centered on this frequency.
	EQ Mid Q	0.5, 1.0, 2.0, 4.0, 8.0 Changes the bandwidth of the mid-frequency range. The bandwidth affected narrows as the value increases.
	EQ High Freq	2000–16000 (Hz) Frequency point in the high-frequency range. This changes the level at and over the specified bandwidth.
Mic Effects	Access the Mic Effects screen. Refer to "Applying Effects to the Mic (Mic Effect)" (p. 22).	
	* On the FP-90X, you can make these settings from the [Mic.] button (p. 22).	
Song Transpose	Transposing the Pitch of the Song Playback (Song Transpose)	
	You can transpose the song playback in semitone steps.	
	-12–0–+12	

Indication [◀] [▶] buttons	Parameter [-] [+] buttons	Explanation
Song Vol. FP-60X	Adjusting the Song Volume (Song Volume)	
	<p>This setting adjusts the volume of your keyboard performance while a song plays back. This adjusts the volume of the song (SMF data / audio data) that is played back.</p> <p>* On the FP-90X, the [Song Vol.] slider simultaneously adjusts the volume of the SMF and the audio.</p> <p>* If the SMF playback mode (p. 27) is set to "Auto-Select" or "Internal," there will be some parts whose volume is not changed by the [Song Vol.]. If you set the SMF playback mode to "External," the volume of all parts will change.</p>	
Input/Bluetooth Vol.	Adjusting the Volume of an Audio Playback Device (Input/Bluetooth Vol.)	
	<p>This setting adjusts the volume of your keyboard performance while a song plays back. You can adjust the volume of an audio playback device that's connected to the Input jacks.</p>	
USB Audio Input Vol.	Adjusting the Volume from the Computer (USB Audio Input Volume)	
	<p>This setting adjusts the volume from the computer when you're playing back audio from a computer connected to the USB Computer port.</p>	
SMF Play Mode	Setting the Song (SMF) Playback Mode (SMF Play Mode)	
	<p>This setting specifies the tone that you play on the keyboard while a song is playing back. Normally you will use the "Auto-Select" setting. This determines whether the setting that is most suitable for the internal song or most suitable for external data is selected when you play back a song whose file format is SMF.</p> <p>Changing this setting does not affect the sound character of tone that you play from the keyboard.</p> <p>MEMO You can also switch the SMF Play Mode by holding down the [▶/■] button and using the [-] [+] button.</p>	
	Auto-Select	Automatically switches the SMF Play Mode to either "Internal" or "External" depending on the song that is being played.
	Internal	When you play back a song, the tone that you play from the keyboard changes to the tone that is saved in the song. This is recommended when you play back an internal song or a song that you recorded on this piano.
	External	<p>The tone that you play from the keyboard does not change when you play back a song.</p> <p>This is recommended when you play back external data such as commercially available music data.</p> <p>* With this setting, some effects might not apply to the song playback sound. For this reason, the character of the sound during playback might be different than the sound while you were recording.</p>
Recording Mode	Selecting the Format for Recording (Recording Mode)	
	<p>You can choose whether to record as SMF or as audio.</p> <p>MEMO You can also switch the Recording Mode by holding down the [●] button and using the [-] [+] button.</p>	
	SMF	The performance is recorded as MIDI data. (SMF format 0)
	Audio	<p>The recording will be made as audio data. (WAV format, 44.1 kHz, 16-bit linear)</p> <p>* If a USB flash drive is not inserted, "Audio" cannot be selected.</p>
Count In Measure	<p>You can change the number of measures that are sounded as a count before song playback or recording begins.</p> <p>* For details on the count in, see the following (p. 18) (p. 19).</p>	
Delete Song	1 Measure, 2 Measures	
Delete Song	Refer to "Deleting a Saved Song (Delete Song)" (p. 20).	
Rename Song	Refer to "Renaming a Song (Rename Song)" (p. 19).	
Copy Song	Refer to "Copying a Saved Song (Copy Song)" (p. 20).	
Format Media	Refer to "Reformatting Memory (Format Media)" (p. 25).	
Damper Pedal Part	Changing How the Pedal Effects Are Applied (Damper Pedal Part)	
	<p>When you press the pedal connected to the Pedal Damper jack during Dual Play or Split Play, the pedal effect is normally applied to both tones, but you can also select the tone to which the effect is to be applied.</p>	
	Right & Left	All enabled
	Right	Applied only to the Tone 1 (in Dual Play)/Right-hand tone (in Split Play)
	Left	Applied only to the Tone 2 (in Dual Play)/Left-hand tone (in Split Play)
Center Pedal	Changing the Function of the Center Pedal (Center Pedal)	
	Use this feature to change the function of the pedal connected to the Pedal Sostenuto jack.	
	Sostenuto *1	Sets function to sostenuto pedal.
	Start/Stop	The pedal will have the same function as the [▶/■] button.
	Layer	In Dual Play, you can control of the Tone 2 volume.
	Soft *2	Sets function to soft pedal.
	Expression *3	Allows control of the volume. You may find it convenient to connect an expression pedal (EV-5: sold separately). Does not change the recorded performance play.
	Master Expression	Controls the overall volume of this unit.
	Bend Up *3 *4	Pitch rises when pedal is depressed.
	Bend Down *3 *4	Pitch is lowered when pedal is depressed.
	Modulation *3 *4	Vibrato is added when pedal is depressed.
	Mic Doubling Sw	The pedal will turn Mic effect "Doubling" on/off.
	Mic Echo Sw	The pedal will turn Mic effect "Echo" on/off.
	Rotary Sw	When using the rotary effect, switches the rotary effect between slow and fast.
*1 Only works on the Center Pedal Function.		
*2 Only works on the Left Pedal Function.		
*3 Works only on the tone set as the corresponding pedal part (Center Pedal Part or Left Pedal Part).		
*4 For some tones, this setting might not apply an effect.		
* Use only the specified expression pedal. By connecting any other expression pedals, you risk causing malfunction and/or damage to the unit.		

English

日本語

Deutsch

Français

Italiano

Español

Português

Nederlands

简体中文

Advanced Operation

Indication [◀] [▶] buttons	Parameter [-] [+] buttons	Explanation
Center Pedal Part	Changing How the Pedal Effects Are Applied (Center Pedal Part)	
	When you press the pedal connected to the Pedal Sostenuto jack during Dual Play or Split Play, the pedal effect is normally applied to both tones, but you can also select the tone to which the effect is to be applied. Refer to "Changing How the Pedal Effects Are Applied (Damper Pedal Part)" (p. 27).	
Left Pedal	Changing the Function of the Left Pedal (Left Pedal)	
	Use this feature to change the function of the pedal connected to the Pedal Soft jack. Refer to "Changing the Function of the Center Pedal (Center Pedal)" (p. 27).	
Left Pedal Part	Changing How the Pedal Effects Are Applied (Left Pedal Part)	
	When you press the pedal connected to the Pedal Soft jack during Dual Play or Split Play, the pedal effect is normally applied to both tones, but you can also select the tone to which the effect is to be applied. Refer to "Changing How the Pedal Effects Are Applied (Damper Pedal Part)" (p. 27).	
Reg. Pedal Shift	Using a Pedal to Switch Registrations (Reg. Pedal Shift)	
	You can assign a pedal to successively switch registrations. Each time you press the pedal, you will switch to the next registration.	
	Off	The functions assigned to the Pedal Soft jack and Pedal Sostenuto jack will be available for use.
	Left Pedal	The pedal connected to the Pedal Soft jack can be used only for switching registrations.
	Center Pedal	The pedal connected to the Pedal Sostenuto jack can be used only for switching registrations.
Reg. Set Export	Refer to "Saving a Registration Set (Registration Set Export)" (p. 24).	
Reg. Set Import	Refer to "Loading a Saved Registration Set (Registration Set Import)" (p. 24).	
	Sending Tone-Change Information (Transmit MIDI Information)	
	When you switch registrations, this unit simultaneously transmits the following: Program Change, Bank Select MSB, and Bank Select LSB. You can also set the transmit channel.	
Reg. Transmit Ch.	Off, 1–16	Sets the Program Change transmit channel.
Reg. Bank MSB	0 (00)–127 (7F)	Sets the Bank Select MSB.
Reg. Bank LSB	0 (00)–127 (7F)	Sets the Bank Select LSB.
Reg. PC	1 (00)–128 (7F)	Sets the Program Change number.
Local Control	Preventing Doubled Notes When Connected to a Sequencer (Local Control)	
	When you have a MIDI sequencer connected, set this parameter to Local Off. Since most sequencers have their Thru function turned on, notes you play on the keyboard may be sounded in duplicate, or get dropped. To prevent this, you can enable the "Local Off" setting so that the keyboard and internal sound generator will be disconnected.	
	Off	Local Control is off. The keyboard is disconnected from the internal sound generator. Playing the keyboard will not produce sound.
	On	Local Control is on. The keyboard is connected to the internal sound generator.
MIDI Transmit Ch.	MIDI Transmit Channel Settings (MIDI Transmit Ch.)	
	This setting specifies the MIDI channel on which the unit will transmit. This unit will receive all sixteen channels (1–16). Off, 1–16	
Display Contrast	Adjusting the Brightness of the Display (Display Contrast)	
	Adjusts the brightness of this unit display. 1–10	
Panel Brightness	Adjusting the Brightness of the Buttons (Panel Brightness)	
	You can adjust the brightness of this unit's buttons. Dim, Bright	
Speaker Auto Mute	Outputting Sound Both from Headphones and Internal Speakers (Speaker Auto Mute)	
	With the factory settings, sound is no longer output from the internal speaker when you connect headphones to the PHONES jack. However, you can change this setting so that sound is output both from the headphones and from the internal speakers. * If this is "Off," the sound that is output from the headphones will have a different character. * If this is "Off," sound is heard from the internal speakers even if the Speaker [Off/On] switch is "Off."	
	Off	Sound is heard both from headphones and the internal speakers.
	On	Sound is heard only from the headphones (default value).
Auto Off	Making the Power Automatically Turn Off After a Time (Auto Off)	
	With the factory settings, the unit's power will automatically be switched off 240 minutes after you stop playing or operating the unit. If you don't want the power to turn off automatically, change the "Auto Off" setting to "Off." Off, 10, 30, 240 (min.)	
Memory Backup	This unit settings return to their factory defaults when you turn off the power. But if you backup the current settings into internal memory, they will be restored the next time the power comes on. Refer to "Retaining Settings After Power-Off (Memory Backup)" (p. 25).	
Factory Reset	Refer to "Restoring the Factory Settings (Factory Reset)" (p. 25).	
Version	Displays the version of the unit's system program.	

* This unit settings return to their factory defaults when you turn off the power. But if you backup the current settings into internal memory, they will be restored the next time the power comes on. Refer to "Retaining Settings After Power-Off (Memory Backup)" (p. 25).

🎵 Troubleshooting

Problem	Items to Check	Action	Page
Even though you're using headphones and the sound is muted, a thumping sound is heard when you play the keyboard	Could you be hearing the sound of the hammers inside the keyboard, or vibrations in the floor or walls?	Playing the keyboard causes internal hammers to operate, and the vibrations may be transmitted to the floor or walls. To minimize such vibrations, you can move the piano away from the wall, or lay down a commercially available anti-vibration mat designed for use with pianos.	-
Power turns off on its own	Could the auto-off setting be something other than "Off"?	If you don't need the power to turn off automatically, turn the Auto Off setting "Off"	p. 28
Power turns on unexpectedly	Is the AC adaptor connected correctly?		-
Pedal does not work, or is "stuck"	Is the pedal connected correctly?		-
	Could you have disconnected or connected the pedal cord while the power was on?	Power-off the unit before you connect or disconnect the pedal cord.	-
	Could you have changed the function of the pedal?	Return the pedal function (Center Pedal, Left Pedal) to its previous setting.	p. 27
	Could you be using the Reg. Pedal Shift function?		p. 28
Unable to read from/write to USB flash drive	Is the USB flash drive connected to the USB Memory port?		-
"Buzz" is heard from external devices	Are the external devices connected to more than one AC power outlet?	If you connect external devices, be sure to connect them to the same AC outlet.	-
The volume level of the unit connected to Input Stereo jack is too low	Could the Input/Bluetooth Vol. be turned down?		p. 27
	Could the volume of the connected device be turned down?		-
No sound	Are your amp, speakers, headphones, etc., connected correctly?		p. 6
	Is the volume turned down?		p. 8
	Could headphones or an adaptor plug be inserted in the Phones jacks? The speakers will not produce sound if headphones or plug are connected to the Phones jacks.		p. 5
	Has Local Control been set to "Off"?	Set Local Control to "On."	p. 28
	Could the Speaker [Off/On] switch be "Off"?		p. 6
	If the Speaker [Off/On] switch is "Off," sound is not output from the internal speakers.		p. 6
	Could the Part [Upper] [Lower] sliders both be lowered? If the Part sliders are lowered, no sound is heard.		p. 8
	Could you be using an expression pedal?	Use an expression pedal to adjust the volume.	-
Sound is heard from the internal speakers even when headphones are connected	Could Speaker Auto Mute be "Off"?		p. 28
Sound is output from the internal speakers even when the Speaker [Off/On] switch is "Off"	If Speaker Auto Mute is "Off," sound is output from the internal speakers even if headphones are connected or if the Speaker [Off/On] switch is "Off."		
No sound from the microphone	Is the [Mic Vol.] slider raised?		p. 22
Mic sound is not loud enough			
Notes don't sound right			
Pitch of the keyboard or song is incorrect	Could you have made Transpose settings?		p. 8
	Is the Master Tune setting appropriate?		p. 26
	Is the setting for the Temperament correct?		p. 26
	Is the Single Note Tuning setting appropriate?		p. 21
Notes are interrupted	Could you be holding down the damper pedal and sounding a large number of notes? Could you be using Dual Play or playing along with a song?		-
Sounds are heard twice (doubled) when the keyboard is played	Is the unit in Dual Play?	Press the [Split/Dual] button to turn off Dual Play.	-
	Could the unit be connected to an external sequencer?	If you don't want the other sound module to produce sound, turn your DAW's soft thru function "off."	-
		If Local Control is turned "On," set Local Control to "Off."	p. 28

Problem	Items to Check	Action	Page
Effect does not apply		For some combinations of tones, the effect does not apply to Dual Play tone 2 or to the left-hand tone of Split Play.	-
Reverberation remains even if you defeat the Ambience effect		Even if the Ambience effect is off, the acoustic piano's own resonance remains. You can reduce this reverberation by adjusting the Cabinet Resonance (FP-90X only).	p. 21
Only high or low sound is heard		Could you have adjusted the equalizer?	p. 26
The sound of the higher notes suddenly changes from a certain key		This simulates the characteristics of an acoustic piano, and is not a malfunction.	-
		The sound will change where there is a change in the number of strings per key or a transition from wound strings to unwound strings.	
High-pitched ringing is heard		If you don't hear it through headphones: It may be that the unit has malfunctioned. Please contact your dealer or a Roland customer service center. If you also hear it through headphones: To decrease the metallic ringing, adjust the following settings. •Duplex Scale (FP-90X only) •Full Scale String Res. (FP-90X only) •Ambience	p. 21
	Could the volume be set to maximum?	Lower the volume.	p. 8
		If you also hear it through headphones: It may be that the unit has malfunctioned. Please contact your dealer or a Roland customer service center. If you don't hear it through headphones: Objects near the unit are resonating because of the high volume of sound coming from the speakers. You can take the following measures to minimize resonances. •Locate the speakers 10–15 cm (4–6 inch) away from walls or other surfaces. •Keep the volume down. •Move away from the objects that are resonating.	
Low notes sound wrong, or are buzzy			-
The selected sound changes when you play back a song	Could the SMF Play Mode be set to "Auto-Select" or "Internal"?	Set the SMF Play Mode to "External."	p. 27
Loud "damper noise" is heard.	Could you be using a damper pedal other than the specified model?	Use a damper pedal that supports continuous detection, such as the DP-10 or KPD-90. If you're using the DP-10, set the DP-10's switch to the "Continuous" position.	p. 6
Song does not play correctly			
The piano's tonal character changes when you record	Could you be recording with a tone that you created in Piano Designer?	The Piano Designer settings might not be reproduced when you play back a song.	-
	Could you be playing back the audiorecorded sound?	Record as SMF.	p. 18
Only the sound of a particular instrument in a song does not play		Could the Part [Upper] [Lower] sliders both be lowered? If the Part sliders are lowered, no sound is heard.	p. 8
Song volume is too low / Volume differs between recording and playback	FP-90X	Could the [Song Vol.] slider be set too low?	p. 8
	FP-60X	Could the Song Vol. settings be too low?	p. 27
		Could the Part [Upper] [Lower] sliders be set to "0"?	p. 8
Can't play back a song saved in USB flash drive		Could the Audio files of the format be played? (WAV or MP3) Audio files of the following format can be played back. • WAV format, 44.1 kHz, 16-bit linear, File extension ".wav" • MP3 format, 44.1 Is the filename extension ".MID"?	-
Song name in USB flash drive is not shown		Could the song name information in the file be blank or consist of only spaces?	-
		Is the filename extension ".MID"?	-
	Could the file name contain two-byte characters (such as Japanese)?	Rename the file so that it consists only of single-byte alphanumeric characters.	-
Can't record			
Can't record audio		Is a USB flash drive connected to the USB Memory port?	-

English

日本語

Deutsch

Français

Italiano

Español

Português

Nederlands

简体中文

🎵 Error Messages

Indication	Meaning
Error 2	An error occurred during writing. The external media may be corrupted. Insert other external media and try again. Alternatively, you can initialize the external media (p. 25).
	The internal memory might be damaged. Format the internal memory (p. 25).
Error 10	No external media is inserted. Insert the external media and try again.
	The internal memory might be damaged. Format the internal memory (p. 25).
Error 11	There is not sufficient free memory in the save destination.
	Either insert other external media or delete unneeded files and try again.
Error 14	An error occurred during reading. The external media may be corrupted. Insert other external media and try again. Alternatively, you can initialize the external media (p. 25).
	The internal memory might be damaged. Format the internal memory (p. 25).
Error 15	The file is unreadable. The data format is not compatible with the unit.
Error 18	This audio format is not supported.
	Please use 44.1 kHz 16-bit linear WAV format or 44.1 kHz 64 kbps–320 kbps MP3 format audio files.
Error 30	Internal memory capacity of the unit is full.
Error 40	The unit cannot deal with the excessive MIDI data sent from the external MIDI device.
	Reduce the amount of MIDI data sent to the unit.
Error 41	A MIDI cable was disconnected. Connect the MIDI cable correctly.
Error 43	A MIDI transmission error has occurred. Check the MIDI cable and connected MIDI device.
Error 51	There may be a problem with the system. Repeat the procedure from the beginning. If it is not solved after you have tried several times, contact the Roland service center.
Error 65	The USB flash drive connector was subjected to excessive current. Make sure that there is no problem with the external media, then turn the power off, then on again.

🎵 Saved Settings

Parameter	Explanation	Settings Saved in Registrations	Items Stored by Memory Backup	Settings Stored Immediately When Edited
	Selected tone (including Split or Dual tones)	●		
	Dual Play On/Off	●		
	Split Play On/Off	●		
	Part Volume	●		
	Split Point	●		
Split Point	Split Point	●		
Right Shift/Left Shift	Octave shift of the right-hand and left-hand tone	●		
Tone 1 Shift/Tone 2 Shift	Octave shift of tone 1 and tone 2	●		
Transpose	Transpose on/off and transpose value	●		
Ambience Type	Ambience type	●*1	●	
Ambience Depth	Depth of the ambience effect	●	●	
Rotary Speed	Modulation speed of the rotary effect	●		
Modulation Speed	Speed at which the sound is modulated	●		
Key Touch	Key Touch	●	●	
Damper Pedal Part	Damper pedal part setting	●		
Center Pedal Part	Center pedal part setting	●		
Center Pedal	Function of the center pedal	●		
Left Pedal Part	Left pedal part setting	●		
Left Pedal	Function of the left pedal	●		
Reg. Pedal Shift	Registration pedal shift setting	●*2		
MIDI Transmit Ch.	MIDI transmit channel	●	●	
Reg. Transmit Ch.				
Reg. PC	Tone switching information	●		
Reg. Bank MSB				
Reg. Bank LSB				
Mic Effects	Mic effects setting	●		
Headphones 3D Ambience	Headphones 3D Ambience		●	
Hammer Response	Hammer response		●	
Metronome	Metronome (volume, sound, downbeat)		●	
Master Tuning	Master Tuning		●	
Temperament	Tuning method		●	
Temperament Key	Base note for the tuning method		●	
Input/Bluetooth Vol.	Input/ Bluetooth volume			●
USB Audio Input Vol.	USB Audio input volume		●	
SMF Play Mode	SMF playback mode		●	
Display Contrast	Display contrast		●	
Panel Brightness	Brightness of the buttons		●	
	All settings of the Bluetooth function			●
Speaker Auto Mute	Settings of the Speaker Auto Mute function		●	
Auto Off	Auto off			●
Equalizer	Equalizer settings		●	

*1 Saved in registrations only for the FP-90X.

*2 The "Reg. Pedal Shift" setting is saved on the USB flash drive when you execute Registration Set Export.

Tone List

Piano

FP-90X

Piano

FP-60X

E. Piano

Organ

Strings/Pad

Synth/Other

#	Tone Name
1	Concert Piano *
2	Stage Grand *
3	Concert Ballad *
4	Concert Mellow *
5	Concert Bright *
6	Concert Brilliance *
7	Stage Mellow *
8	Stage Bright *
9	Upright Piano
10	Mellow Upright
11	Bright Upright
12	Rock Piano
13	Ragtime Piano
14	Bright Forte
15	SA Piano
16	JD Piano
17	70's E.Grand
18	Magical Piano
19	Harpsichord
20	Harpsi 8'+4'

#	Tone Name
1	Concert Piano *
2	Ballad Piano *
3	Mellow Piano *
4	Bright Piano *
5	Upright Piano
6	Mellow Upright
7	Bright Upright
8	Rock Piano
9	Ragtime Piano
10	Bright Forte
11	SA Piano
12	JD Piano
13	70's E.Grand
14	Magical Piano
15	Harpsichord
16	Harpsi 8'+4'

* Tones with the (*) symbol are "SuperNATURAL Piano sound engine" tones.

* Tones with the (*) symbol are "PureAcoustic Piano sound engine" tones.

#	Tone Name
1	1976SuitCase
2	Tine EP Lite
3	ModifiedDyno
4	VR EP 1
5	Wurly 200
6	Pure Wurly
7	Phase EP Mix
8	80's FM EP
9	MetalicEP Ex
10	SA E.Piano 1
11	SA EP1 Stack
12	SA E.Piano 2
13	JD8 CrystIEP
14	Glassy EP 1
15	Tremolo EP
16	EP Belle
17	BrillClav DB
18	BrillClavWah

#	Tone Name
1	B.Organ Slow
2	Combo Jz.Org
3	Ballad Organ
4	Gospel Spin
5	Full Stops
6	Mellow Bars
7	Lower Organ
8	Light Organ
9	Pipe Organ
10	Nason flt 8'
11	ChurchOrgan1
12	ChurchOrgan2
13	Accordion
14	Acd Musette
15	Acd Harmonm
16	Animal Mod
17	Surf Monkeys
18	Rising Sun

#	Tone Name
1	Chamber Str
2	String Exp
3	Full Strings
4	Strings forl
5	Epic Strings
6	Rich Strings
7	SymphonicStr1
8	SymphonicStr2
9	Orchestra
10	String Trio
11	Harpiness
12	OrchestraBrs
13	Super SynPad
14	Choir Aahs 1
15	Choir Aahs 2
16	D50 StackPad
17	Legend Pad
18	Voice of Hvn
19	New Jupiter
20	ChordofCnada
21	JP8 Strings
22	Air Pad
23	Boreal Pad
24	JP8 Hollow
25	Soft Pad
26	Solina
27	Tron Strings

#	Tone Name
1	Super Saw
2	Trancy Synth
3	Flip Pad
4	D50 Fantasia
5	D50 Stac Hvn
6	D50 FuturePd
7	D50 DigiNDnc
8	EQ Lead
9	DelyResoSaws
10	StrawberyFlt
11	Jazz Scat
12	Ac.Bass wRel
13	Comp'd JBass
14	A.Bass+Cymb1
15-23	(8-drum sets and 1 SFX set)
24-279	(GM2 Tones)

English

日本語

Deutsch

Français

Italiano

Español

Português

Nederlands

简体中文

Internal Song List

Common to FP-90X/FP-60X

Song Name	Composer
Elevations	* Original
Reflection	* Original
Fly day	* marasy
Barcarolle	* Fryderyk Franciszek Chopin
Zhavoronok	* "Mikhail Ivanovich Glinka, Arranged by Mily Alexeyevich Balakirev"
Valse, op.34-1	* Fryderyk Franciszek Chopin
Polonaise op.53	* Fryderyk Franciszek Chopin
Nocturne No.20	* Fryderyk Franciszek Chopin
Die Forelle	* Franz Peter Schubert, Arranged by Franz Liszt
Reflets dans l'Eau	* Claude Achille Debussy
Polovtsian Dances	Alexander Borodin
Ombra mai fù	George Frideric Handel
Lascia ch'io pianga	George Frideric Handel
Twinkle Twinkle Little Star	French Folk Song
Mary Had a Little Lamb	Traditional
Bear Song	American Folk Song
Ich Bin Ein Musikante	German Folk Song
Grand Father's Clock	Henry Work
Jingle Bells	James Pierpont
We Wish You a Merry Christmas	Carol

Song Name	Composer
Silent Night	Franz Gruber
Amazing Grace	Hymn
Lavender's Blue	Traditional
Aura Lee	George R. Poulton
Auld Lang Syne	Traditional
Greensleeves	Traditional
Maple Leaf Rag	Scott Joplin
The Entertainer	Scott Joplin
When The Saints Go Marching In	Traditional
Little Brown Jug	Joseph Winner
Singing Winds	Original
City Lights	Original

FP-90X only

Song Name	Composer
Amazing Grace	* Hymn
Nocturne, op.9-2	* Fryderyk Franciszek Chopin

* All rights reserved. Unauthorized use of this material for purposes other than private, personal enjoyment is a violation of applicable laws.

* Performance data of the tone demos and the built-in songs is not output from the USB Computer port or from Bluetooth (MIDI).

* If the SMF playback mode (p. 27) is set to "Auto-Select" or "Internal," there will be some parts whose volume is not changed by the [Song Vol.]. If you set the SMF playback mode to "External," the volume of all parts will change.

* Songs marked by an asterisk (*) are piano solo songs. They have no accompaniment.

* "Fly day" are played by marasy

USING THE UNIT SAFELY

⚠ WARNING

Concerning the Auto Off function

The power to this unit will be turned off automatically after a predetermined amount of time has passed since it was last used for playing music, or its buttons or controls were operated (Auto Off function). If you do not want the power to be turned off automatically, disengage the Auto Off function (p. 28).



Use only the stand that is recommended

This unit should be used only with a stand that is recommended by Roland.



Do not place in a location that is unstable

When using the unit with a stand recommended by Roland, the stand must be carefully placed so it is level and sure to remain stable. If not using a stand, you still need to make sure that any location you choose for placing the unit provides a level surface that will properly support the unit, and keep it from wobbling.



Precautions regarding placement of this unit on a stand

Be sure to follow the instructions in the Owner's Manual carefully when placing this unit on a stand (p. 2).



If it is not set up properly, you risk creating an unstable situation which could lead to the unit falling or the stand toppling, and may result in injury.

⚠ WARNING

Use only the supplied AC adaptor and the correct voltage

Be sure to use only the AC adaptor supplied with the unit. Also, make sure the line voltage at the installation matches the input voltage specified on the AC adaptor's body. Other AC adaptors may use a different polarity, or be designed for a different voltage, so their use could result in damage, malfunction, or electric shock.



Use only the supplied power cord

Use only the attached power cord. Also, the supplied power cord must not be used with any other device.



⚠ CAUTION

Use only the specified stand(s)

This unit is designed to be used in combination with specific stands (*1) manufactured by Roland. If used in combination with other stands, you risk sustaining injuries as the result of this product dropping down or toppling over due to a lack of stability.



*1 FP-90X: KSC-90, KS-G8B, KS-10Z, KS-12, KS-20X
FP-60X: KSC-72, KS-G8B, KS-10Z, KS-12, KS-20X

⚠ CAUTION

Evaluate safety issues before using stands

Even if you observe the cautions given in the owner's manual, certain types of handling may allow this product to fall from the stand, or cause the stand to overturn. Please be mindful of any safety issues before using this product.



Cautions when moving this unit

Since this product is very heavy, you must make sure that a sufficient number of people are on hand to help, so you can lift and move it safely, without causing strain. Make sure to have a firm grip, to protect yourself from injury and the instrument from damage. If you need to move the instrument, take note of the precautions listed below.



- Check to make sure the Knob Bolt securing the unit to the stand have not become loose. Fasten them again securely whenever you notice any loosening.
- Disconnect the power cord.
- Disconnect all cords coming from external devices.
- Remove the music stand.

Keep small items out of the reach of children

To prevent accidental ingestion of the parts listed below, always keep them out of the reach of small children.



- Removable Parts
Music rest attachment screws (FP-90X only) (p. 5)

IMPORTANT NOTES

Placement

- Do not allow objects to remain on top of the keyboard. This can be the cause of malfunction, such as keys ceasing to produce sound.
- Depending on the material and temperature of the surface on which you place the unit, its rubber feet may discolor or mar the surface.

Care of the Keyboard

- Do not write on the keyboard with any pen or other implement, and do not stamp or place any marking on the instrument. Ink will seep into the surface lines and become unremovable.
- Do not affix stickers on the keyboard. You may be unable to remove stickers that use strong adhesives, and the adhesive may cause discoloration.
- To remove stubborn dirt, use a commercially available keyboard cleaner that does not contain abrasives. Start by wiping lightly. If the dirt does not come off, wipe using gradually increasing amounts of pressure while taking care not to scratch the keys.

Repairs and Data

- Before sending the unit away for repairs, be sure to make a backup of the data stored within it; or you may prefer to write down the needed information. Although we will do our utmost to preserve the data stored in your unit when we carry out repairs, in some cases, such as when the memory section is physically damaged, restoration of the stored content may be impossible. Roland assumes no liability concerning the restoration of any stored content that has been lost.

Additional Precautions

- Any data stored within the unit can be lost as the result of equipment failure, incorrect operation, etc. To protect yourself against the irretrievable loss of data, try to make a habit of creating regular backups of the data you've stored in the unit.
- Roland assumes no liability concerning the restoration of any stored content that has been lost.
- Never strike or apply strong pressure to the display.
- The sound of keys being struck and vibrations produced by playing an instrument can be transmitted through a floor or wall to an unexpected extent. Please take care not to cause annoyance to others nearby.

- Do not apply undue force to the music stand while it is in use.
- Use only the specified expression pedal. By connecting any other expression pedals, you risk causing malfunction and/or damage to the unit.
- Do not use connection cables that contain a built-in resistor.

Using External Memories

- Please observe the following precautions when handling external memory devices. Also, make sure to carefully observe all the precautions that were supplied with the external memory device.
 - Do not remove the device while reading/writing is in progress.
 - To prevent damage from static electricity, discharge all static electricity from your person before handling the device.

Caution Regarding Radio Frequency Emissions

- The following actions may subject you to penalty of law.
 - Disassembling or modifying this device.
 - Removing the certification label affixed to the back of this device.
 - Using this device in a country other than where it was purchased

Intellectual Property Right

- It is forbidden by law to make an audio recording, video recording, copy or revision of a third party's copyrighted work (musical work, video work, broadcast, live performance, or other work), whether in whole or in part, and distribute, sell, lease, perform or broadcast it without the permission of the copyright owner.
- Do not use this product for purposes that could infringe on a copyright held by a third party. We assume no responsibility whatsoever with regard to any infringements of third-party copyrights arising through your use of this product.
- The copyright of content in this product (the sound waveform data, style data, accompaniment patterns, phrase data, audio loops and image data) is reserved by Roland Corporation.
- Purchasers of this product are permitted to utilize said content (except song data such as Demo Songs) for the creating, performing, recording and distributing original musical works.
- Purchasers of this product are NOT permitted to extract said content in original or modified form, for the purpose of distributing recorded medium of said content or making them available on a computer network.
- This product contains eParts integrated software platform of eSOL Co., Ltd. eParts is a trademark of eSOL Co., Ltd. in Japan.
- The **Bluetooth**® word mark and logos are registered trademarks owned by **Bluetooth SIG, Inc.** and any use of such marks by Roland is under license.
- This Product uses the Source Code of μ T-Kernel under T-License 2.0 granted by the T-Engine Forum (www.tron.org).
- This product includes third party open source software.
 - Copyright © 2009-2018 Arm Limited. All rights reserved.
 - Copyright © 2018 STMicroelectronics. All rights reserved.
 - Licensed under the Apache License, Version 2.0 (the "License"); You may obtain a copy of the License at <http://www.apache.org/licenses/LICENSE-2.0>
 - Copyright © 2018 STMicroelectronics. All rights reserved.
 - This software component is licensed by ST under BSD 3-Clause license, the "License"; You may obtain a copy of the License at <https://opensource.org/licenses/BSD-3-Clause>
 - This product is using the Jansson (<http://www.digip.org/jansson/>) source code.
 - Copyright © 2009-2016 Petri Lehtinen <petri@digip.org>
 - Released under the MIT license <http://opensource.org/licenses/mit-license.php>
- Roland, SuperNATURAL, PureAcoustic, Piano Every Day are either registered trademarks or trademarks of Roland Corporation in the United States and/or other countries.
- Company names and product names appearing in this document are registered trademarks or trademarks of their respective owners.

Internal Song Music Book

内蔵曲楽譜集

1 : Elevations
2 : Reflection

FP-90X
FP-60X
FP-30X
Roland Digital Piano

Elevations

Original

Allegro (♩ = ca.140)

The musical score is written for piano in 3/4 time. It consists of four systems of music. The first system starts with a tempo marking of 'Allegro (♩ = ca.140)' and a dynamic of 'mf playful'. The second system includes a 'rit.' marking. The third system is marked 'a tempo'. The fourth system includes a 'poco rit.' marking and ends with a 'mp' dynamic. The score features various chords and pedaling instructions throughout.

Chords: C, C6, G7/C, Dm, G9, Am, C/G, F, C/G, G, C, F/A, C/G, F6, Dm7, C, G, C.

Dynamics: *mf playful*, *rit.*, *a tempo*, *poco rit.*, *mp*.

Pedaling: Ped. (multiple instances throughout the score).

C Cmaj7 Am

And.

C/B C Cmaj7

And.

Am C/B Poco slower

And.

Fmaj7 C/G G Fmaj7

mf *expressivo*

And.

Gsus4 G C Più mosso Dm/A Fmaj7

And.

C/E F6 Am7 F/A

Ped. mf

A^bmaj7 Fm6 C/G a tempo G

f rit. mf Ped.

G Fmaj7 G

rit. Ped.

C Tempo I Cmaj7 Am

playful Ped.

Fm6 *a tempo* C/G Gsus4

poco rit. *expressivo*

This system shows the beginning of a piano accompaniment. The right hand starts with a half note chord Fm6 (Bb, D, F) and a melodic line. The left hand provides harmonic support with chords Fm6, C/G, and Gsus4. Performance directions include 'poco rit.' and 'expressivo'.

G Fmaj7 C/G G

This system continues the piano accompaniment with chords G, Fmaj7, C/G, and G. The melodic line in the right hand continues across the system.

A^bmaj7 **Più mosso** B^b6

This system introduces a tempo change to 'Più mosso'. The right hand features a melodic line with eighth notes, and the left hand provides harmonic support with chords A^bmaj7 and B^b6.

A^bmaj7 B^b6 *poco rit.*

This system continues the 'Più mosso' section with chords A^bmaj7 and B^b6. The tempo is marked 'poco rit.' at the end of the system.

C

This system concludes the piano accompaniment with a C chord. The right hand has a melodic line, and the left hand has a bass line.

Reflection

Original

Moderate (♩ = ca.112)

C

mf

Ped. Ped.

Am F F6 Fmaj7 Dm7

Ped. Ped. Ped.

C

Ped. Ped.

F G F/A G7/B

Ped. Ped. Ped. Ped.

C

And. *And.*

Am G/B F#m7^{b5} F

a tempo

poco rit.

And. *And.* *And.* *And.*

C E^b6

And. *And.*

C E^b6

poco rit.

And. *And.*

C

And.

