

RP701 F701

Owner's Manual

What You Can Do with the RP701/F701

Play the Piano

🎵 **Play the piano sounds of your dream** 🎹 page 12

This piano contains a variety of piano tones ranging from concert grand piano to upright piano. It also contains the sound of a harpsichord, which is the ancestor of the piano. You'll be sure to find piano sounds to your taste.

🎵 **Play string, organ, and percussion tones** 🎸 page 12

You can also choose tones of instruments other than piano. Using tones other than the usual choices can provide a pleasant change, or you can layer other tones with a piano tone to enjoy especially rich sonorities.

Practice songs

🎵 **Practice along with a metronome** 🕒 page 14

You can practice while listening to a metronome. By changing the tempo or time signature as appropriate for the song you're playing, you can improve your ability to keep the rhythm.

🎵 **Practice along with the internal songs** 📖 page 13

Built into this piano are numerous well-known songs in a variety of genres such as classical, jazz, and practice pieces. You can listen to these internal songs as models, or adjust the tempo and practice along with them.

🎵 **Practice one hand at a time** 🎵 page 13

By playing back a song with the sound of the right-hand or left-hand part muted, you can hear the performance one hand at a time. This also lets you practice along with the song one hand at a time.

🎵 **Record your performance** ● page 14

You can listen again to your own performance that you just recorded, and use it to improve your next performance. You can also save your performance for your family member or piano teacher to hear.

Take advantage of Bluetooth

🎵 **Play back music through the piano's speakers (Bluetooth audio function)** 📶 page 16

You can connect a smartphone or tablet, and listen to your favorite songs through the piano's speakers. By performing along with a song, you can enjoy being part of your favorite music.

🎵 **Use with piano with apps (Bluetooth MIDI function)** 📶 page 17

You can use an app to find new musical scores, and use the practice support functions to experience new possibilities in piano performance.

Download the apps

Download these smartphone/tablet apps and use them with your piano. iOS/iPadOS
Android

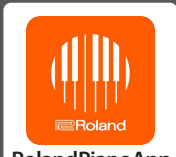

Roland Piano App

This app lets you view sheet music in digital form, practice songs as if you were playing a game, or keep a record of your practicing.





Piano Designer

This app lets you customize the piano sound to your taste.



Before using this unit, carefully read "USING THE UNIT SAFELY" and "IMPORTANT NOTES" (leaflet "USING THE UNIT SAFELY" and Owner's Manual (p. 47)). After reading, keep the document(s) where it will be available for immediate reference.

- English
- 日本語
- Deutsch
- Français
- Italiano
- Español
- Português
- Nederlands
- 简体中文

Contents

Quick Operation	3
Panel Descriptions (RP701)	4
Before You Play (RP701)	6
Panel Descriptions (F701)	8
Before You Play (F701)	10
Playing	12
Listening to Songs	13
Practicing/Recording	14
Connecting a Mobile Device via Bluetooth	15
Reference	19
Connecting the Equipment	20
Playing	21
Playing Different Tones with the Left and Right Hand	21
Playing Two Tones Layered on Each Key	21
Changing the Settings for Dual Play	21
Adjusting the Sound's Ambience and Brightness	22
Changing the Keyboard Touch	22
Practicing with the Metronome	22
Changing the Settings for Metronome	22
Listening to Songs	23
Playing Back a Song	23
Recording Your Performance	24
Recording Your Keyboard Performance	24
Getting Ready to Record	24
Starting/Stopping Recording	24
Listening to the Recorded Performance	24
Deleting a Saved Song	24
Managing Songs You Recorded	24
Copying a Recorded Song	25
Advanced Recording Methods	25
Recording Your Performance One Hand at a Time	25
Overdubbing a Recorded Performance	26
Recording Audio to USB Flash Drive	26
Creating Your Own Piano Tone (Piano Designer)	27
Adjusting the Sound of the Overall Piano	27
Editing the Grand Piano Tone	28
Connecting the Piano and a Mobile Device via Bluetooth	29
Play Music Through the Piano's Speakers (Bluetooth Audio) ...	29
Using the Piano with an App (Bluetooth MIDI)	30
If Pairing Does Not Succeed in "Using the Piano with an App"	31
Convenient Functions	32
Loading/Saving Piano Setups	32
Saving Piano Settings (Piano Setup Export)	32
Loading Piano Settings (Piano Setup Import)	32
Initializing the Memory (Format Media)	33
Restoring the Factory Settings (Factory Reset)	33
Disabling the Buttons (Panel Lock)	33

Making Various Settings (Function Mode)	34
Basic Settings in Function Mode	34
Turning the Bluetooth Function On/Off (Bluetooth On/Off)	34
Adjusting the Volume of Bluetooth Audio (Input/Bluetooth Vol.)	34
Playing Different Tones with the Left and Right Hand	35
Playing Two Tones Layered on Each Key	35
Dividing the Keyboard for Two People (Twin Piano)	35
Transposing the Pitch of the Song Playback (Song Transpose)	35
Adjusting the Song (SMF) Volume (Song Volume SMF)	35
Adjusting the Song (Audio) Volume (Song Volume Audio) ..	35
Adjusting the Volume of an Audio Playback Device (Input/Bluetooth Vol.)	36
Adjusting the Volume from the Computer (USB Audio Input Volume)	36
Setting the Song (SMF) Playback Mode (SMF Play Mode) ...	36
Changing How the Pedal Effects Are Applied (Damper Pedal Part)	36
Changing How the Pedals Work (Center Pedal)	36
Changing the Effect of the Pedal (Left Pedal)	37
Preventing Doubled Notes When Connected to a Sequencer (Local Control)	37
MIDI Transmit Channel Settings (MIDI Transmit Ch.)	37
Changing the Language Displayed in the Screen (Language)	37
Adjusting the Brightness of the Display (Display Contrast) ..	37
Specifying the Time Until the Operating Panel Dims (Screen Saver)	37
Specifying a Maximum Volume (Volume Limit)	37
Outputting Sound Both from Headphones and Internal Speakers (Speaker Auto Mute)	37
Making the Power Automatically Turn off After a Time (Auto Off)	38
Saving Settings Automatically (Auto Memory Backup)	38
Settings Saved Even If the Power Is Turned Off	38
Troubleshooting	39
Error Messages	41
Tone List	43
Internal Song List	45
USING THE UNIT SAFELY	47
IMPORTANT NOTES	48
Index	49

Quick Operation

How to read Quick Operation

Here we explain what you need to know before using this piano, and basic ways to use the piano.

This section is divided into pages with explanations that apply to models separately and pages that are common to all models. Read the pages that apply to your model of piano.

For more details on how to use the piano, read "Reference."

If you're using the RP701

Read the pages that are marked "RP701" in their upper right and pages that are marked "RP701 F701" in their upper right.

RP701

RP701
RP701 F701

page4 - page7

page12 - page16

Panel Descriptions

RP701

RP701 F701

page4 - page7

page12 - page16

Panel Descriptions

RP701

RP701 F701

page4 - page7

page12 - page16

If you're using the F701

Read the pages that are marked "F701" in their upper right and pages that are marked "RP701 F701" in their upper right.

F701

F701
RP701 F701

page8 - page11

page12 - page16

Panel Descriptions

F701

F701
RP701 F701

page8 - page11

page12 - page16

Panel Descriptions

F701

F701
RP701 F701

page8 - page11

page12 - page16

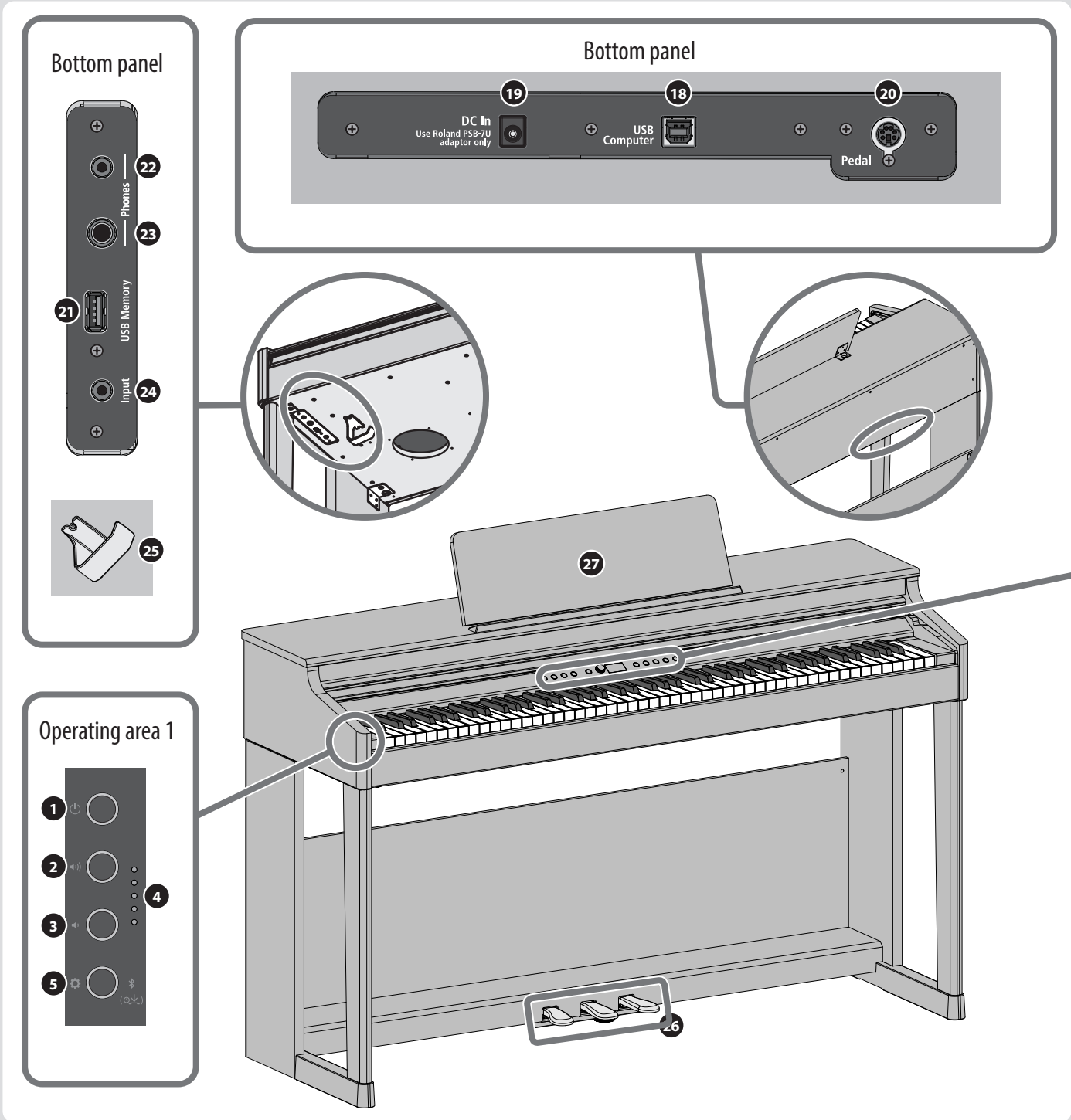

Bottom panel

- 18** **USB Computer port**
Connect this to your computer for music production and editing. (p. 20)
- 19** **DC In jack**
Connect the included AC adaptor here. (p. 6)
- 20** **Pedal jack**
Connect the pedal cord here. (p. 20)
- 21** **USB Memory port**
Connect a USB flash drive here for audio recording or for playing back songs from the USB flash drive. (p. 20)
- 22** **Phones jacks (stereo mini)**
- 23** **Headphone jack (stereo 1/4")**
Connect headphones here to play the piano without producing sound from the internal speakers. (p. 7)
- 24** **Input jack (stereo mini)**
Sound from your audio player can be input here and heard from the piano. (p. 20)
- 25** **Headphone hook**
You can leave your headphones here when not using them. (p. 7)

Operating area 1

- 1 [⏻] (Power) button
Turns the power on/off. (p. 6)
- 2 [🔊] (Volume+) button
- 3 [🔊] (Volume-) button
Adjust the overall volume of the piano when playing the keyboard or when playing back songs. (p. 6)
- 4 Volume indicator
Lit according to the specified volume. (p. 6)
- 5 [⚙️] (settings) button
Lets you make various settings. (p. 34)
- [📶] (Bluetooth)
Long-press this to connect with your mobile device. (p. 16)

Operating area 2

Selecting and playing tones

- 6 [🎹] (Piano) button
Lets you select and play piano tones. (p. 12)
- 7 [🎹] (other) button
Lets you select and play a variety of tones other than piano. (p. 12)
🎹 + 🎹 (Dual Play)
By pressing the two buttons simultaneously, you can play two tones as a layer. (p. 21)

Basic operation

- 10 [↩] (back) button
Returns to the previous screen, or exits the current screen. (p. 7)
- 11 [⏵] (select/confirm) knob
Changes or confirms an item or value shown in the screen. (p. 7)
- 12 Display
This shows information such as the tone name, song name, tempo, and time signature.

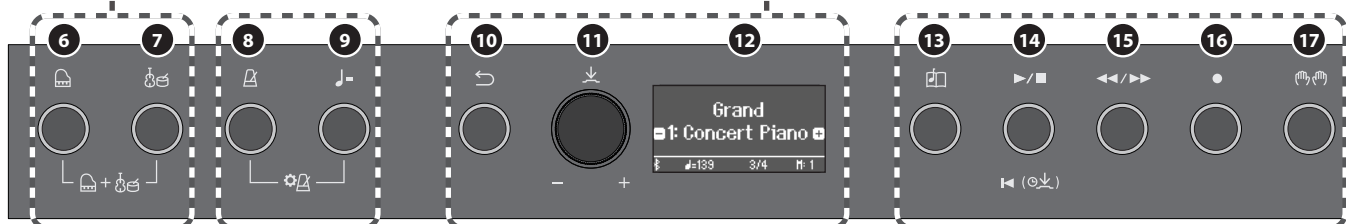

Practicing

- 8 [🎵] (metronome) button
Lets you practice along with a metronome. (p. 14)
- 9 [♩] (Tempo) button
Changes the tempo of the metronome or song. (p. 14) (p. 13)
[⚙️] (metronome settings)
By pressing the two buttons simultaneously, you can make metronome settings. (p. 22)

Playing back or recording a song

- 13 [📄] (song) button
Selects songs. (p. 13)
- 14 [▶/■] (play/stop) button
Plays back or stops the song. (p. 13)
[⏮] (beginning of song)
Long-press this button to select the beginning of the song. (p. 23)
- 15 [⏪/⏩] (measure) button
Advances or returns the measure within the song to the desired position. (p. 23)
- 16 [●] (recording) button
Records a song. (p. 14)
- 17 [🎹] (part) button
 - Lets you select the performance part (right-hand, left-hand, accompaniment) that will play back. (p. 13)
 - This also lets you record parts separately. (p. 25)

Other

- 26 Pedal
By pressing the pedals, you can apply effects to the sound of the piano. (p. 7)
- 27 Music rest
Place printed music here. (p. 7)

Opening/Closing the Keyboard Cover

You must use both hands to open or close the keyboard cover.

Opening the Keyboard Cover

1. Use both hands to lift the edge of the keyboard cover, and push it away from yourself.

NOTE

If you have any objects (papers, metal objects, etc.) placed on top of the keyboard cover, do not open the cover. Otherwise, such objects may slip inside the instrument, and then become irrecoverable.

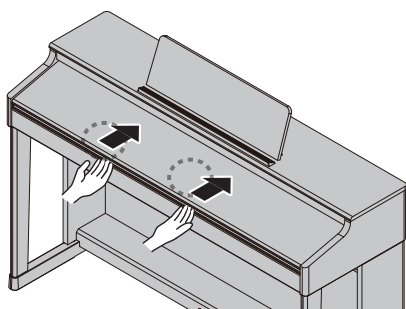

Closing the Keyboard Cover

1. Grasp and gently lower the edge of the keyboard cover with both hands.

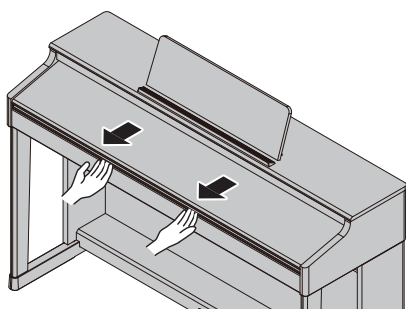

NOTE

- When opening / closing the keyboard cover or you operate the pedals, please be careful not to get your fingers pinched between the movable part and the unit. In places where small children are present, make sure that an adult provides supervision and guidance.
- Do not apply undue force to the music rest while it is in use.

Using the keyboard cover to conceal the panel (Classic Position)

If you raise the keyboard cover slowly, it stops at a position that hides the buttons and the display. If you use the cover to hide the operation panel, you'll be able to play as though you were playing an acoustic piano. When you push the cover further inward and up, it stops in a position where the operation panel is visible.

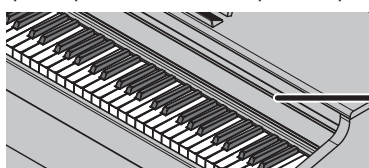

Keyboard cover

Turning the Power On/Off

Connecting the AC adaptor

1. Connect the AC adaptor to the DC In jack located on the bottom of the piano.

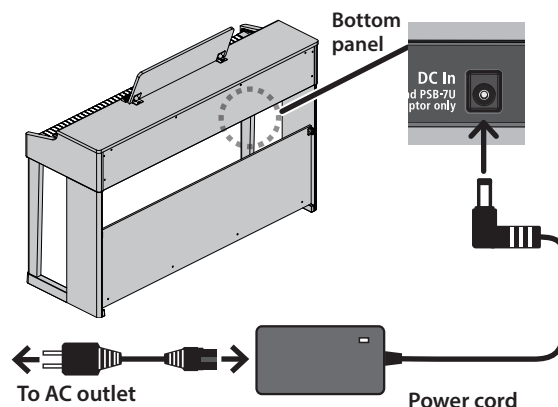

Turning the Power On

1. Turn the [⏻] button ON.

After a brief interval, you'll be able to produce sounds by playing the keyboard.

Before turning the unit on/off, always be sure to turn the volume down. Even with the volume turned down, you might hear some sound when switching the unit on/off. However, this is normal and does not indicate a malfunction



2. Use the Volume buttons to adjust the volume.

The volume increases when you press the [🔊] button, and decreases when you press the [🔇] button.

The volume indicator lights according to the volume.

This will adjust the volume of the speakers if you're using the speakers of the unit, or the volume of the headphones if headphones are connected. Each volume setting is saved automatically.



Turning Off the Power

1. Long-press the [⏻](power) button.

NOTE

With the factory settings, the unit's power will automatically be switched off 30 minutes after you stop playing or operating the unit.

If you don't want the power to turn off automatically, change the "Auto Off" setting to "OFF" as described on "Making the Power Automatically Turn Off After a Time (Auto Off)" (p. 38).

When the power turns off, any unsaved data is lost. If there is data that you want to keep, save it beforehand.

If the unit's power has been turned off automatically, you can use the [⏻] button to turn the unit back on again.

Using the Headphones

Use headphones if you want to perform without the sound being heard nearby. This piano has two headphone jacks, two people can also use headphones simultaneously.

1. Connect headphones to the headphone jacks located on the bottom panel.

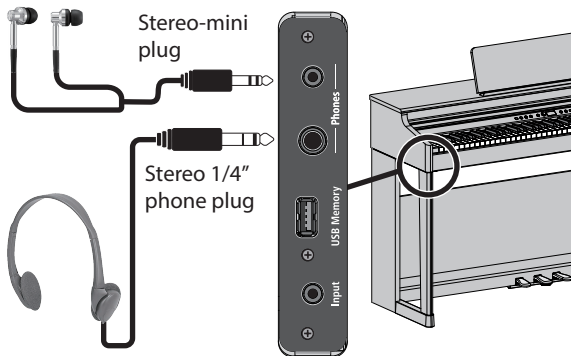

NOTE

When you connect headphones, sound is no longer heard from the piano's speakers.

2. Use the Volume buttons to adjust the volume of the headphones.

MEMO

- A Headphones 3D Ambience effect will be applied, producing the sensation that the sound is emanating from the piano itself even when using headphones (p. 22).
- Whenever you are not using the headphones, you can hang them on the headphone hook.



Using the Music rest

1. Loosen the music rest screws slightly (2–3 mm), insert the music rest brackets between the screws and the body of the piano, and turn the screws to secure the music rest while using one hand to support the music rest.

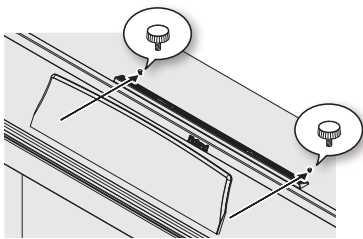

When attaching the music rest, make sure that it is firmly inserted all the way toward the back, and use your hand to support the music rest so that it does not fall. Also take care not to pinch your hand.

- * Do not apply excessive force to the music rest.
- * If you need to remove the music rest, loosen the screws while using one hand to support the music rest. Detach the music rest, and then firmly retighten the screws.

Basic Operations of Functions

To operate the functions of this piano, you use the [↵] (select/confirm) knob and the [⏪] (back) button.

Change an on-screen item or value	Turn the [↵] knob
Confirm	Press the [↵] knob
Move the “-” “+” symbols in the screen	Press the [↵] knob
Return to the previous screen / Exit the current screen	Press the [⏪] button
Return to the default value	Long-press the [↵] knob

Moving the “-” “+” symbols

In some screens, the upper and lower lines of the screen let you change different items or values. (Example: The upper line changes the category, and the lower line changes the tone.) In such screens, the location of the “-” “+” symbols alternates between the upper and lower lines each time you press the [↵] knob, and turning the [↵] knob changes the item or value of the line where the symbols are located.

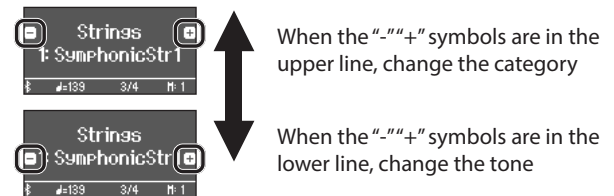

Using the Pedals

By pressing the pedals, you can apply effects to the sound of the piano.

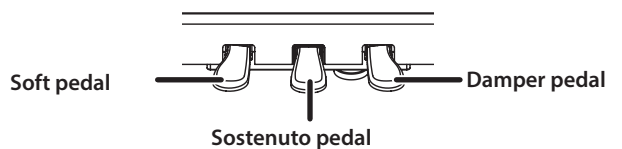

Damper pedal (right)	Use this pedal to sustain the sound. While this pedal is held down, notes will be sustained for an extended time even if you release your fingers from the keyboard. The resonance of the sound is affected by how deeply you press the pedal.
Sostenuto pedal (center)	The notes you are pressing when this pedal is depressed will be sustained.
Soft pedal (left)	This pedal is used to make the sound softer. Playing with the soft pedal depressed produces a sound that is not as strong as when otherwise played with the equivalent strength. The softness of the tone can be varied subtly by the depth to which you press the pedal.

* When opening / closing the keyboard cover or you operate the pedals, please be careful not to get your fingers pinched between the movable part and the unit. In places where small children are present, make sure that an adult provides supervision and guidance.

NOTE

Under the pedals there is an adjuster for securing the pedals. As you use the piano, the adjuster might creep upward, allowing the pedals to wobble when you step on them. If this occurs, turn the adjuster to lower it into firm contact with the floor. In particular if the piano is placed on carpet, you should lower the adjuster so that it firmly presses down on the floor.

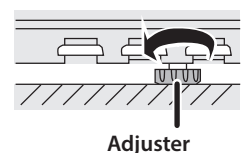

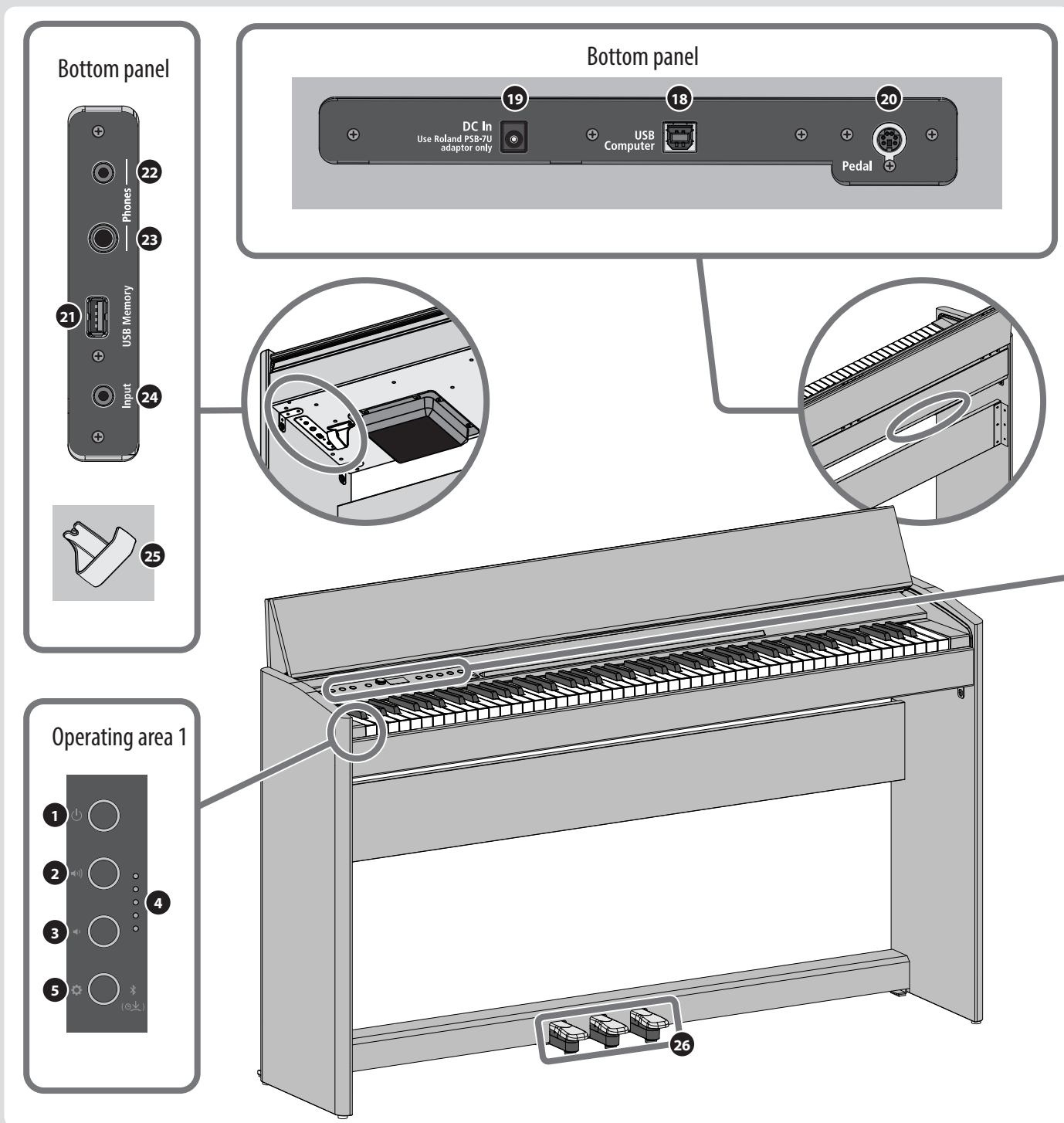

Bottom panel

- 18** **USB Computer port**
Connect this to your computer for music production and editing. (p. 20)
- 19** **DC In jack**
Connect the included AC adaptor here. (p. 10)
- 20** **Pedal jack**
Connect the pedal cord here. (p. 20)
- 21** **USB Memory port**
Connect a USB flash drive here for audio recording or for playing back songs from the USB flash drive. (p. 20)
- 22** **Phones jacks (stereo mini)**
- 23** **Headphone jack (stereo 1/4")**
Connect headphones here to play the piano without producing sound from the internal speakers. (p. 11)
- 24** **Input jack (stereo mini)**
Sound from your audio player can be input here and heard from the piano. (p. 20)
- 25** **Headphone hook**
You can leave your headphones here when not using them. (p. 11)

Operating area 1

- 1 [⏻] (Power) button
Turns the power on/off. (p. 10)
- 2 [🔊] (Volume+) button
- 3 [🔊-] (Volume-) button
Adjust the overall volume of the piano when playing the keyboard or when playing back songs. (p. 10)
- 4 Volume indicator
Lit according to the specified volume. (p. 10)
- 5 [⚙️] (settings) button
Lets you make various settings. (p. 34)
- [📶] (Bluetooth)
Long-press this to connect with your mobile device. (p. 16)

Operating area 2

Selecting and playing tones

- 6 [🎹] (Piano) button
Lets you select and play piano tones. (p. 12)
- 7 [🎹] (other) button
Lets you select and play a variety of tones other than piano. (p. 12)
🎹 + 🎹 (Dual Play)
By pressing the two buttons simultaneously, you can play two tones as a layer. (p. 21)

Basic operation

- 10 [↩️] (back) button
Returns to the previous screen, or exits the current screen. (p. 11)
- 11 [⏴] (select/confirm) knob
Changes or confirms an item or value shown in the screen. (p. 11)
- 12 Display
This shows information such as the tone name, song name, tempo, and time signature.

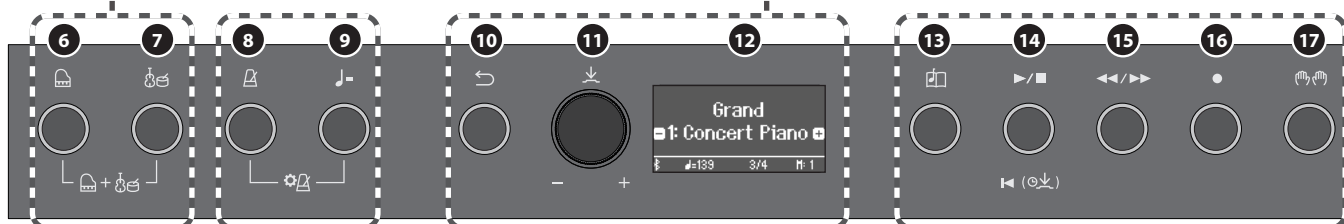

Practicing

- 8 [🎵] (metronome) button
Lets you practice along with a metronome. (p. 14)
- 9 [♩=] (Tempo) button
Changes the tempo of the metronome or song. (p. 14) (p. 13)
[⚙️] (metronome settings)
By pressing the two buttons simultaneously, you can make metronome settings. (p. 22)

Playing back or recording a song

- 13 [📄] (song) button
Selects songs. (p. 13)
- 14 [▶/■] (play/stop) button
Plays back or stops the song. (p. 13)
[⏴] (beginning of song)
Long-press this button to select the beginning of the song. (p. 23)
- 15 [⏮/⏭] (measure) button
Advances or returns the measure within the song to the desired position. (p. 23)
- 16 [●] (recording) button
Records a song. (p. 14)
- 17 [🎹] (part) button
 - Lets you select the performance part (right-hand, left-hand, accompaniment) that will play back. (p. 13)
 - This also lets you record parts separately. (p. 25)

Other

- 26 Pedal
By pressing the pedals, you can apply effects to the sound of the piano. (p. 11)

Opening/Closing the Keyboard Cover

You must use both hands to open or close the keyboard cover.

Opening the Keyboard Cover

1. Use both hands to lift the edge of the keyboard cover, and push it away from yourself.

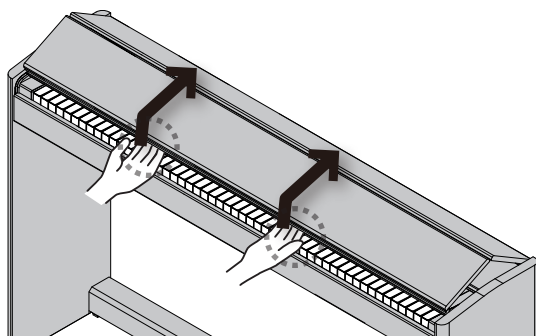

2. Push the keyboard cover away from yourself until it stops.

Closing the Keyboard Cover

1. Grasp and gently lower the edge of the keyboard cover with both hands.

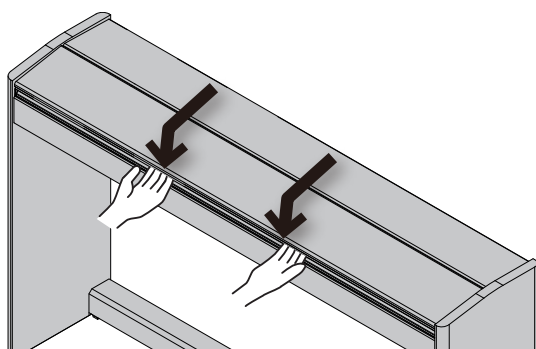

NOTE

- When opening / closing the keyboard cover or you operate the pedals, please be careful not to get your fingers pinched between the movable part and the unit. In places where small children are present, make sure that an adult provides supervision and guidance.
- If you need to move the piano, make sure the keyboard cover is closed first to prevent accidents.

When opening or closing the keyboard cover, take care not to pinch your fingers between the folding sections.

It is dangerous to close the keyboard cover by pressing it from above, since you risk pinching your fingers between the sections of the keyboard cover.

Opening the keyboard cover by pushing it may cause this unit to fall over. You must grasp the edge of the keyboard cover when opening or closing it.

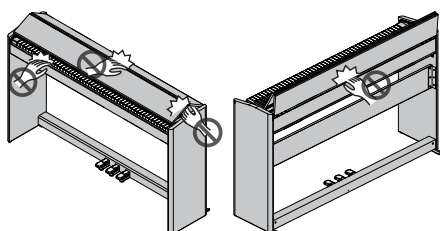

Turning the Power On/Off

Connecting the AC adaptor

1. Connect the AC adaptor to the DC In jack located on the bottom of the piano.

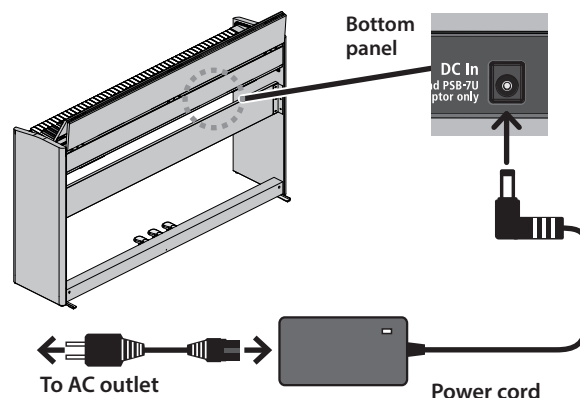

Turning the Power On

1. Turn the [⏻] button ON.

After a brief interval, you'll be able to produce sounds by playing the keyboard.

- * Before turning the unit on/off, always be sure to turn the volume down. Even with the volume turned down, you might hear some sound when switching the unit on/off. However, this is normal and does not indicate a malfunction



2. Use the Volume buttons to adjust the volume.

The volume increases when you press the [🔊] button, and decreases when you press the [🔇] button.

The volume indicator lights according to the volume.

This will adjust the volume of the speakers if you're using the speakers of the unit, or the volume of the headphones if headphones are connected. Each volume setting is saved automatically.

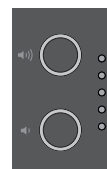

Turning Off the Power

1. Long-press the [⏻](power) button.

NOTE

With the factory settings, the unit's power will automatically be switched off 30 minutes after you stop playing or operating the unit.

If you don't want the power to turn off automatically, change the "Auto Off" setting to "OFF" as described on "Making the Power Automatically Turn Off After a Time (Auto Off)" (p. 38).

- When the power turns off, any unsaved data is lost. If there is data that you want to keep, save it beforehand.
- If the unit's power has been turned off automatically, you can use the [⏻] button to turn the unit back on again.

Using the Headphones

Use headphones if you want to perform without the sound being heard nearby. This piano has two headphone jacks, two people can also use headphones simultaneously.

1. Connect headphones to the headphone jacks located on the bottom panel.

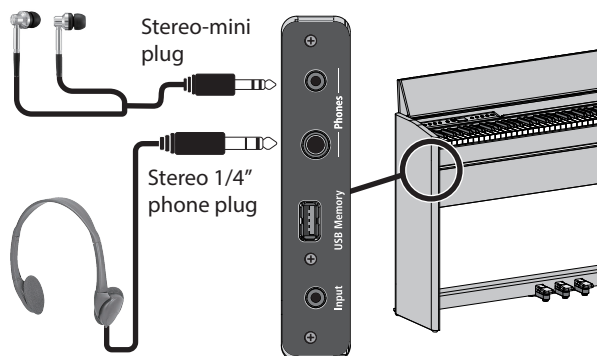

NOTE

When you connect headphones, sound is no longer heard from the piano's speakers.

2. Use the Volume buttons to adjust the volume of the headphones.

MEMO

- A Headphones 3D Ambience effect will be applied, producing the sensation that the sound is emanating from the piano itself even when using headphones (p. 22).
- Whenever you are not using the headphones, you can hang them on the headphone hook.



Basic Operations of Functions

To operate the functions of this piano, you use the [↵] (select/confirm) knob and the [⏪] (back) button.



Change an on-screen item or value	Turn the [↵] knob
Confirm	Press the [↵] knob
Move the "-" "+" symbols in the screen	Press the [↵] knob
Return to the previous screen / Exit the current screen	Press the [⏪] button
Return to the default value	Long-press the [↵] knob

Moving the "-" "+" symbols

In some screens, the upper and lower lines of the screen let you change different items or values. (Example: The upper line changes the category, and the lower line changes the tone.) In such screens, the location of the "-" "+" symbols alternates between the upper and lower lines each time you press the [↵] knob, and turning the [↵] knob changes the item or value of the line where the symbols are located.

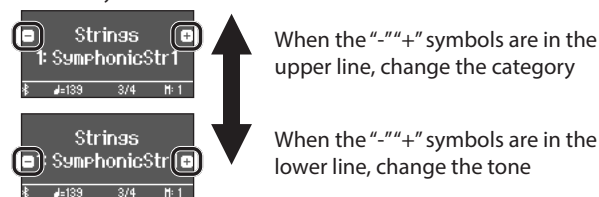

Using the Pedals

By pressing the pedals, you can apply effects to the sound of the piano.

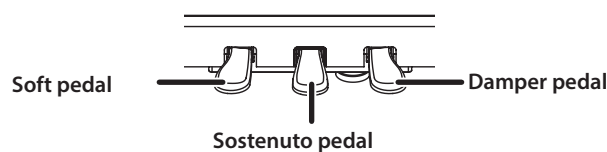

Damper pedal (right)	Use this pedal to sustain the sound. While this pedal is held down, notes will be sustained for an extended time even if you release your fingers from the keyboard. The resonance of the sound is affected by how deeply you press the pedal.
Sostenuto pedal (center)	The notes you are pressing when this pedal is depressed will be sustained.
Soft pedal (left)	This pedal is used to make the sound softer. Playing with the soft pedal depressed produces a sound that is not as strong as when otherwise played with the equivalent strength. The softness of the tone can be varied subtly by the depth to which you press the pedal.

* When opening / closing the keyboard cover or you operate the pedals, please be careful not to get your fingers pinched between the movable part and the unit. In places where small children are present, make sure that an adult provides supervision and guidance.

Selecting a Tone

This piano lets you enjoy performing piano tones and a variety of tones other than piano. The tones are organized into two groups, "piano" and "other"; press a tone button to select the corresponding group.

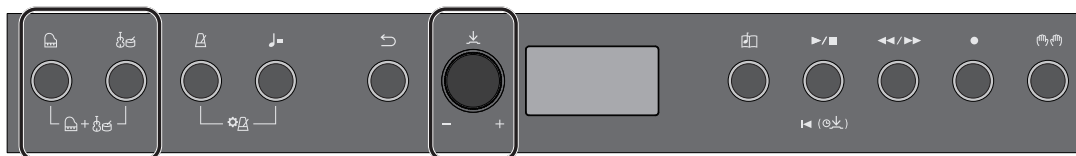

Selecting piano tones

Press the [Piano] button to select various types of piano tone.

1. Press the [Piano] button.

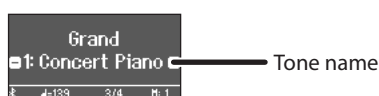

A piano tone is selected.

2. Turn the [Knob] knob to select other piano tones.

Piano tones are organized into four categories.

By continuing to turn the [Knob] knob, you can successively select piano tones of the next category.

Typical piano tones (grand tone category)

Display	Explanation
Concert Piano	The sound of a splendid concert grand piano. This piano sound has our highest recommendation, and can be used for any style of music.
Ballad Piano	A mellow grand piano sound, recommended for quiet songs.
Mellow Piano	A grand piano sound that's even more mellow than Ballad Piano. It is ideal for songs of a soft and relaxed atmosphere.
Bright Piano	A brilliant grand piano sound, recommended when you want the piano to stand out in an ensemble.

Selecting a category

1. Press the [Knob] knob to move the "-" "+" symbols to the upper line of the screen.



2. Turn the [Knob] knob to select a category.

To select a tone, press the [Knob] knob once again to move the "-" "+" symbols to the lower line of the screen, and then select a tone.

Categories of the [Piano] button

Display	Explanation
Grand	Grand piano tones
Upright	Upright piano or ragtime piano tones
Classical	Fortepiano and harpsichord tones
E.Piano	Electric piano tones often used in pop and rock

➔ For details on the piano tones of categories other than Grand, refer to "Tone List" (p. 43).

Selecting other tones

Press the [Other] button to select a variety of tones other than piano.

1. Press the [Other] button.



The tone is selected.

2. Turn the [Knob] knob to select other tones.

Like the piano tones, the tones of the Other group are also organized into several categories. The method of selecting a category is the same as when selecting piano tones.

➔ For details on the tones that can be selected via the [Other] button, refer to "Tone List" (p. 43).

Categories of the [Other] button

Display	Explanation
Strings	Tones of instruments used in an orchestra, mainly string instruments such as violin
Organ	Tones such as pipe organ * If you've selected a tone to which modulation is applied (a rotary effect), you can change the speed of modulation by pressing the [Other] button.
Voice	Human vocal sounds of scat singing. The voice will change in four stages according to the strength at which you play the note.
Do Re Mi	Notes you play are sounded as "do-re-mi" (solfege).
Drums	Lets you select sounds of percussion instruments such as drums and percussion.
GM2	Lets you select GM2 sounds.

Playing Back a Song

Here's how you can listen to the built-in songs. You can listen to these internal songs as models for your own playing, or practice one hand at a time along with them.

The internal songs are organized into several categories.

1. Press the [] button.



The Song screen appears.

2. Turn the [] knob to select the song category.



As an example, let's select the "Listening" category.

3. Press the [] knob to move the "-" "+" symbols to the lower line of the screen.

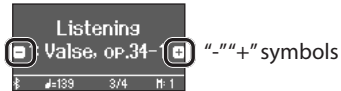

4. Turn the [] knob to select the song.

In this example, we'll select "Valse, op.34-1."

5. Press the [] button.



The button is lit, and the song plays.

6. To stop the song, press the [] button once again.

The button goes dark.

Category list

Category	Explanation
Listening	Piano songs recommended for listening
Ensemble	Famous songs, mainly classical pieces. These include piano concertos, duets, and jazz arrangements of classical pieces. Since this collection contains songs that are challenging to play, they are recommended for those at intermediate level or above.
Entertainment	Arrangements of well-known songs from around the world, including pop, jazz, and children's songs, in arrangements that can be enjoyed by a wide range of people from the beginner to the advanced player.
Do Re Mi Lesson	You can use these lessons to learn the basics of music, by singing solfège along with the songs or practicing score-reading.
Scales	Scales in all keys (major scales, minor scales)
Hanon	The Virtuoso Pianist No.1-20
Beyer	Vorschule im Klavierspiel Op.101 No.1-106
Burgmüller	25 Études faciles et progressives Op.100
Czerny100	100 Übungsstücke Op.139
USB Memory	Songs saved on a USB flash drive
Internal Memory	Songs saved in internal memory

➔ For details on the internal songs, refer to "Internal Song List" (p. 45).

Playing back individual performance parts

The built-in songs consist of three parts (right-hand, left-hand, accompaniment), and you can play back just the part(s) that you want to hear.



1. Press the [] button.

2. Turn the [] knob to select the part that you want to mute.

3. Press the [] knob to confirm.

In this example, only the left-hand part plays back.

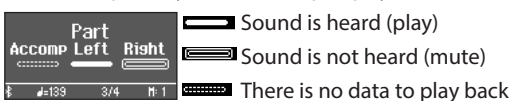

* Some songs don't have a left-hand part or an accompaniment part. In this case, you can't select the corresponding part.

4. Press the [] button.

Only the parts that you want to hear will play. You can also practice by playing the muted part as you listen to the playback.

Change the song tempo

You can practice at a tempo that's easy for you to play.

1. After selecting a song, press the [] button.



The display shows the tempo of the song.

2. Turn the [] knob to change the tempo numerically.

The song tempo changes.

3. Practice along with the song playback.

Changing the tempo as a tempo indication

1. Press the [] knob to move the "-" "+" symbols to the lower line of the screen.



2. Turn the [] knob to select a tempo indication.

The song tempo changes according to the tempo indication you selected.

Practicing with the Metronome

Here's how to perform along with the metronome. You can also change the metronome's tempo and time signature.

1. Press the [A] button.



The button blinks, and you hear the metronome.

2. Practice along with the metronome.
3. To stop the metronome, press the [A] button once again.

The button goes dark.

Changing the tempo

1. Press the [J=] button.



The display shows the current tempo.

2. Turn the [↘] knob to change the tempo.

Changing the time signature

1. Press the [A] button and [J=] button simultaneously.



The Metronome setting screen appears.

2. Turn the [↘] knob to access the "Beat" screen.
3. Press the [↘] knob to move the "-" "+" symbols to the lower line of the screen.



4. Turn the [↘] knob to select the time signature.

Available time signatures	2/2, 3/2, 2/4, 3/4, 4/4, 5/4, 6/4, 7/4, 3/8, 6/8, 8/8, 9/8, 12/8 (default value: 4/4)
---------------------------	---

5. Press the [↩] button several times to return to the previous screen.

Recording Your Keyboard Performance

You can record your own keyboard performance, and then play back to check it.

Getting Ready to Record

1. Select the tone that you want to play.
2. You can sound the metronome if you like.
Press the [A] button.
While listening to the metronome, specify the song's tempo and time signature.

Starting/Stopping Recording

3. Press the [●] button.



The [●] button lights, the [▶/■] button blinks, and the piano enters record-standby mode.

If you decide to cancel recording, press the [●] button once again.

4. Press the [▶/■] button.



After a one-measure count, recording starts, and the [●] button and [▶/■] button are both lit.

MEMO

You can also start recording by playing the keyboard instead of pressing the [▶/■] button. In this case, a count is not sounded.

5. Play.

6. To stop recording, press the [▶/■] button once again.

Recording stops.

The performance is saved automatically.

Listening to the Recorded Performance

7. Press the [▶/■] button.
After you record, the newly recorded song is selected.
The recorded song starts playing back.

Deleting a Saved Song

1. While holding down the [●] button, press the [↩] button.



The "Delete Song - Media" screen appears.

2. Press the [↘] knob to confirm.



The "Delete Song - Song" screen appears.

3. Press the [↘] knob to confirm.
A confirmation message appears.
4. Turn the [↘] knob to select "Yes," and press the [↘] knob to confirm.
The deletion is executed.

Here's What You Can Do

By using the Bluetooth function, you can wirelessly connect the piano with a mobile device such as your smartphone or tablet, allowing you to do the following things.

Music played back by the mobile device can be heard through the piano's speakers.

A song played back on your mobile device can be heard wirelessly through the piano's speakers. You can also play the piano along with the song that's being played back.

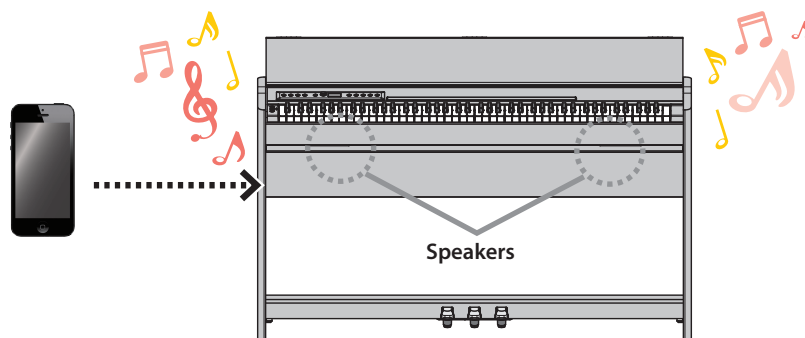

You can use apps to expand your piano enjoyment.

You can install apps (such as Roland's "Roland Piano App" and "Piano Designer") on your mobile device and use them together with the piano.

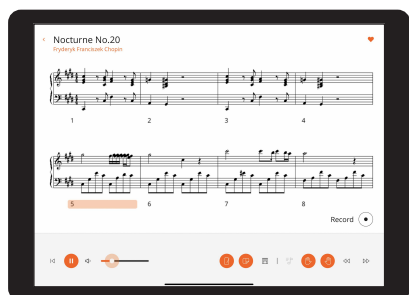

Roland Piano App



Piano Designer

Pairing

To wirelessly connect the piano with your mobile device, you must first perform "pairing" to create a one-to-one connection between the piano and your mobile device.

"Pairing" is the procedure of registering (mutually authenticating) your mobile device with the piano.

Pair your device as described in the procedure for each function.

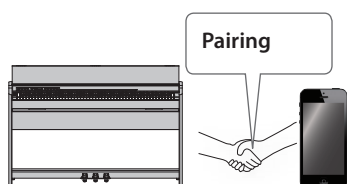

The pairing process

Separate pairing is required for "playing music through the piano's speakers" and for "using the piano with an app." Note that these processes are different.

- ➔ "Initial settings (pairing)" (p. 16)
- ➔ "Making settings (pairing)" (p. 17)

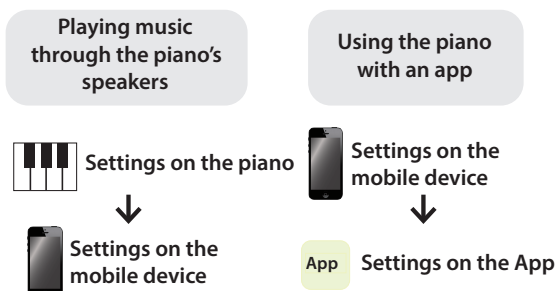

Play Music Through the Piano's Speakers (Bluetooth Audio)

A song played back on your mobile device can be heard wirelessly through the piano's speakers.

Making Initial Settings (Pairing)

As an example, we explain how to make settings for an iPad. If you're using an Android device, refer to the owner's manual of the mobile device you're using.

1. Place the mobile device that you want to connect near the piano.
2. Long-press the piano's [Settings] button (⌘). (⌘).

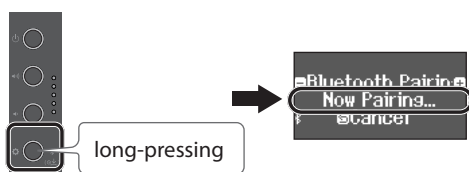

When the piano's display indicates "Now Pairing," release your finger.

3. Turn on the Bluetooth function of the mobile device.



4. Tap "RP701 Audio" or "F701 Audio" that is shown in the Bluetooth device screen of your mobile device.

The piano and mobile device are paired. When pairing succeeds, the word "AUDIO" appears in the piano's display as shown below.



5. Press the piano's [Settings] button (⌘) to return to the previous screen.

* The mobile device that has been paired with the piano does not need to be paired again the next time. Simply turn on the Bluetooth function of the mobile device, and it will reconnect with the piano.

Playing Back Audio

1. Play back music data on the mobile device.
You hear sound from the piano's speakers.
2. Adjust the volume on your mobile device.

Using the Piano with an App (Bluetooth MIDI)

Here's how to make settings so that you can use the piano with an app that's installed on your mobile device.

Downloading the app

In advance, download the app to your mobile device. (p. 1)

Making Settings (Pairing)

As an example, we show the procedure for using the "Roland Piano App" app on an iOS device. If you're using an Android device, refer to the owner's manual of your mobile device for details on how to make Bluetooth function settings.

1. Turn on the Bluetooth function of the mobile device.



NOTE

Even if the "DEVICES" field shows the name of the device you're using (such as "RP701 MIDI"), do not tap it.

2. Start the app that you installed on your mobile device.

3. Tap "Connect piano".

4. Tap either "RP701 MIDI" or "F701 MIDI" depending on the unit that you're using.

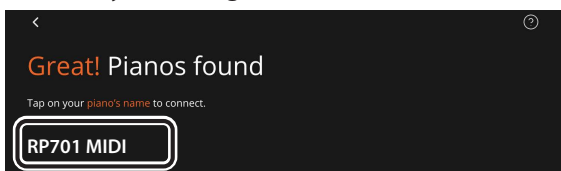

When "Bluetooth Pairing Request" is shown, tap "Pair".

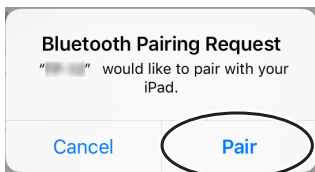

The piano and mobile device are paired. When pairing is completed, a display like the following appears.

Mobile device	"Connected with RP701 MIDI or F701 MIDI" appears in the "Connection" area at the top of the app screen.
Piano	The "MIDI" is shown beside the Bluetooth symbol.

This completes the settings.

➔ If pairing does not succeed (p. 31)

MEMO

When connecting to a mobile device for which you've initialized the settings, the device automatically connects when you launch the app. The connection may take several seconds.

- * If the piano doesn't connect with your mobile device, tap "Connection" at the top of the app screen, and then tap "Connect to Piano".

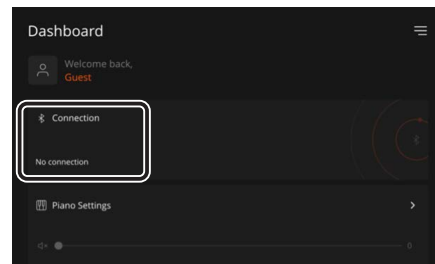

Reference

How to read the Reference section

This section explains more advanced ways to use the piano and how to deal with problems. For basic use, refer to “Quick Operation.” Lists of the tones and the internal songs are provided at the end of this section.

This content is common to both the RP701 model and the F701 model.

English

日本語

Deutsch

Français

Italiano

Español

Português

Nederlands

简体中文

Connecting the Equipment

Bottom Panel

* To prevent malfunction and equipment failure, always turn down the volume, and turn off all the units before making any connections.

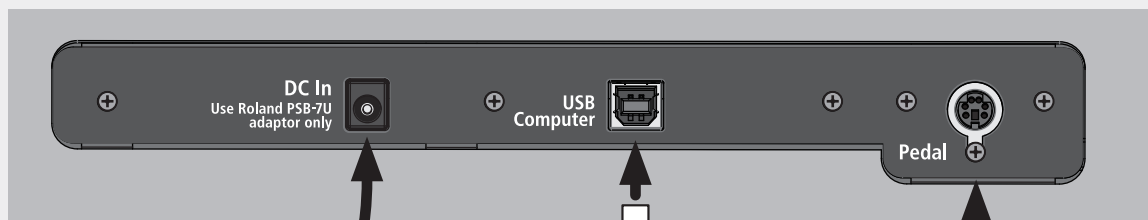

DC In jack

Connect the included AC adaptor here.

page 6

page 10

Headphone Jacks

Here you can connect stereo headphones.

page 7

page 11

USB Computer port

Connect a computer here. Use a USB cable (commercially available) to make this connection. This lets the piano exchange performance data with sequencer software (commercially available) on your computer, allowing you to produce and edit music.



Pedal jack

Connect the pedal cord.



USB Memory port

Here you can connect a USB flash drive. You can use it to record your piano performance as audio, or use the piano to play back music data (WAVE files, MIDI files, MP3 files) from the USB flash drive. (p. 26, p. 23)

* Never turn off the power or disconnect a USB flash drive or the power cord while the USB flash drive is blinking.

* Taking care that the USB flash drive is oriented correctly, firmly insert it all the way into the port. Do not use excessive force.



Input jack

Connect an audio player or smartphone. Sound that's played back by the audio player can be heard from the piano's speakers. You can also play the piano along with the song playback. Use a stereo mini-plug cable (commercially available) to make this connection.



Playing Different Tones with the Left and Right Hand

You can perform using different tones in the left and right regions of the keyboard, divided at a specific note. This setting is called "Split Play," and the point at which the keyboard is divided is called the "split point."

1. Press the [⚙️] button.

The [⚙️] button is lit, and the piano is in function mode.

2. Turn the [↔️] knob to access the "Keyboard Mode" screen.

3. Press the [↔️] knob to confirm, and then turn the [↔️] knob to select "Split."

4. Press the [⚙️] button to exit function mode.

The split screen appears.



When you turn the power on, "Concert Piano" is selected as the right-hand tone and "A.Bass+Cymb" is selected as the left-hand tone.

When split turns on, the keyboard settings are as follows.

Split point (Power-up default): F#3

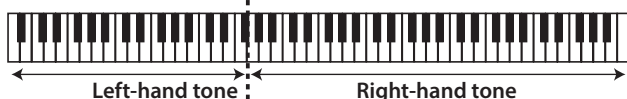

5. To exit Split Play, press the [⚙️] button to enter function mode, and change "Keyboard Mode" to "Whole."

Changing the settings for Split Play

To edit the following settings, access the Split screen.

	Operating the Unit
Changing the left-hand tone (Split-Left Tone)	<ol style="list-style-type: none"> Press the [⏮] button or the [🔊] button. The tone group is selected. Turn the [↔️] knob to select a tone. * If you select a sound from the [⏮] button as the left-hand tone, it sounds different than usual.
Changing the right-hand tone (Split-Right Tone)	<ol style="list-style-type: none"> Press the [↔️] knob so that "-""+" is shown in the top line of the screen. Turn the [↔️] knob to access "Right Tone" screen. Press the [↔️] knob to confirm. Press the [⏮] button or the [🔊] button. The tone group is selected. Turn the [↔️] knob to select a tone.
Changing the point at which tones are separated (Split-Point)	<ol style="list-style-type: none"> Press the [↔️] knob so that "-""+" is shown in the top line of the screen.
Changing the volume balance of the left-hand tone and right-hand tone (Split-Balance)	<ol style="list-style-type: none"> Turn the [↔️] knob to access the screen of the item you want to set. Press the [↔️] knob to confirm.
Changing the octave of the left-hand tone and right-hand tone (Split-Left/Right Shift)	<ol style="list-style-type: none"> Turn the [↔️] knob to select the value that you want to change.

Playing Two Tones Layered on Each Key

You can play two tones simultaneously from a single key. This function is called "Dual Play."

1. Press the [⚙️] button.

The [⚙️] button is lit, and the piano is in function mode.

2. Turn the [↔️] knob to access the "Keyboard Mode" screen.

3. Press the [↔️] knob to confirm, and then turn the [↔️] knob to select "Dual."

4. Press the [⚙️] button to exit function mode.

The dual screen appears.



When you turn the power on, "Concert Piano" is selected for tone 1 and "SymphonicStr1" is selected for tone 2.

5. To exit Dual Play, press the [⚙️] button to enter function mode, and set "Keyboard Mode" to "Whole."

MEMO

You can also access the Dual screen by pressing the [⏮] button and [🔊] button simultaneously. Press the buttons simultaneously once again to exit Dual Play.

Changing the Settings for Dual Play

To edit the following settings, access the Dual screen.

	Operating the Unit
Changing tone 2 (Dual-Tone 2)	<ol style="list-style-type: none"> Press the [⏮] button or the [🔊] button. The tone group is selected. Turn the [↔️] knob to select a tone. * If you select a sound from the [⏮] button as tone 2, it sounds different than usual.
Changing tone 1 (Dual-Tone 1)	<ol style="list-style-type: none"> Press the [↔️] knob so that "-""+" is shown in the top line of the screen. Turn the [↔️] knob to access "Tone 1" screen. Press the [↔️] knob to confirm. Press the [⏮] button or the [🔊] button. The tone group is selected. Turn the [↔️] knob to select a tone.
Changing the volume balance of the two tones (Dual-Balance)	<ol style="list-style-type: none"> Press the [↔️] knob so that "-""+" is shown in the top line of the screen. Turn the [↔️] knob to access the screen of the item you want to set.
Changing the octave of the two tones (Dual-Tone 1/Tone 2 Shift)	<ol style="list-style-type: none"> Press the [↔️] knob to confirm. Turn the [↔️] knob to select the value that you want to change.

Adjusting the Sound's Ambience and Brightness

You can add reverberant ambience to the sound as though you were performing in a concert hall. You can also adjust the tonal brightness of your keyboard performance or the song playback.

1. Press the [⊗] button.

The button is lit, and the piano is in function mode.

2. Turn the [↵] knob to select the screen of the item that you want to set.

3. Press the [↵] knob to confirm, and then turn the [↵] knob to choose the desired value.

Ambience	Higher values produce deeper ambience; lower values produce shallower ambience.
	<ul style="list-style-type: none"> The reverberation effect is not applied to audio files. 0–10 (default value: 1)
Headphones 3D Ambience	You can apply a Headphones 3D Ambience effect that creates the impression that the sound is being heard from the piano itself even when you're using headphones.
	<ul style="list-style-type: none"> The Headphones 3D Ambience effect applies only to piano sounds; it does not apply to other sounds. The reverberation effect is not applied to audio files. Off, On (default value: On)
Brilliance	Higher values produce brighter sounds.
	-10–0–+10 (default value: 0)

4. To exit the setting, press the [⊗] button to exit function mode.

Changing the Keyboard Touch

You can change the playing feel (touch) of the keyboard.

1. Press the [⊗] button.

The button is lit, and the piano is in function mode.

2. Turn the [↵] knob to access the "Key Touch" screen.

3. Press the [↵] knob to confirm, and then turn the [↵] knob to choose the desired value.

50 (default)	This touch setting is closest to that of an acoustic piano.
1–100	Higher values make the keyboard feel heavier.
Fix	The sound is heard at a fixed volume regardless of how strongly you play the keyboard.

4. To exit the setting, press the [⊗] button to exit function mode.

Practicing with the Metronome

You can practice while hearing a metronome.

➔ "Practicing with the Metronome" (p. 14)

Changing the Settings for Metronome

You can change various other settings of the metronome in addition to its tempo and time signature.

1. Press the [⊗] button and [J=] button simultaneously.

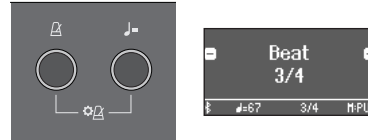

The Metronome setting screen appears.

2. Turn the [↵] knob to access the screen of the item that you want to set.

3. Press the [↵] knob to confirm.

4. Turn the [↵] knob to change the setting.

Beat	2/2, 3/2, 2/4, 3/4, 4/4, 5/4, 6/4, 7/4, 3/8, 6/8, 8/8, 9/8, 12/8 (default value: 4/4)
Metronome Downbeat	If this is on, the first beat (downbeat) of the metronome is played with a stronger sound. Off, On (default value: On)
Metronome Pattern	Changes the pattern of the metronome. Off, Eighth note, Eighth-note triplet, Shuffle, Sixteenth note, Quarter-note triplet, Quarter note, Dotted eighth (default value: Off)
Metronome Volume	Changes the metronome's volume Off, 1–10 (default value: 5)
Metronome Tone	Changes the tone of the metronome. Click, Electronic, Voice (Japanese), Voice (English) (default value: Click)

5. To exit the setting, press the [↵] button.

Reading the note name (e.g., C4)

The alphabetical indication for settings such as "split point" shows the name of the note.

For example, the indication "C4" means "the fourth 'C' from the left edge of the keyboard."



Listening to Songs

Playing Back a Song

Here's how you can listen to the built-in songs. You can listen to these internal songs as models for your own playing, or practice one hand at a time along with them.

- ➔ "Internal Song List" (p. 45)
- ➔ "Song Categories" (p. 13)

1. Press the [F1] button.

The Song screen appears.

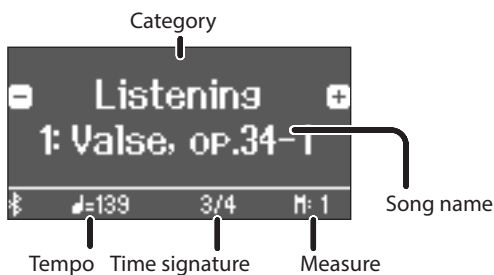

2. Turn the [L] knob to select a song category.

3. Press the [L] knob to move the "-" "+" symbols to the lower line of the screen.

4. Turn the [L] knob to select the song name.

You can choose song names within the category.

MEMO

To re-select the song category, press the [F1] button.

5. Press the [▶/■] button.

The button is lit, and the song plays.

6. To stop the song, press the [▶/■] button once again.



The button goes dark.

7. To exit song settings, press the [F1] button.

The button goes dark.

Changing how songs play back

	Operating the Unit
Playing back individual performance parts	The built-in songs consist of three parts (right-hand, left-hand, accompaniment), and you can play back just the part(s) that you want to hear. ➔ "Playing back individual performance parts" (p. 13)
Change the song tempo	➔ "Change the song tempo" (p. 13)
Return the song tempo to its initial value	1. Press the [♩=] button. The Tempo screen appears. 2. Long-press the [L] knob. The tempo returns to its initial value.
Play back the song at a constant tempo (Tempo mute)	This is convenient when you want to practice along with the song playback. 1. Hold down the [▶/■] button and press the [♩=] button. To defeat tempo mute, once again hold down the [▶/■] button and press the [♩=] button.

	Operating the Unit
Selecting the measure to play back	1. Press the [◀◀/▶▶] button.  The measure screen appears. 2. Turn the [L] knob to select the measure that you want to play. 3. Press the [▶/■] button. The song plays from the specified measure. MEMO • If you long-press the [▶/■] button (◀ (⊙L)), the beginning of the song is selected. • Press the [◀◀/▶▶] button or the [⏪] button to return to the previous screen.
Sounding a count before the song plays	1. While holding down the [F1] button, press the [▶/■] button.
Play all songs in the selected category	1. While holding down the [F1] button, press the [▶/■] button.
Playing back in a different key	1. Press the [✂] button. The [✂] button is lit, and the piano is in function mode. 2. Turn the [L] knob to access the "Song Transpose" screen.  3. Press the [L] knob to confirm. 4. Turn the [L] knob to select the number of semitones that you want to transpose. 5. Press the [▶/■] button. The song playback is transposed.
Playing songs from a folder on a USB flash drive	1. Press the [F1] button, and turn the [L] knob to select "USB Memory."  2. Press the [L] knob to confirm. Enter the folder 3. Turn the [L] knob to select the desired folder. 4. Press the [L] knob to confirm. Exit the folder 5. Turn the [L] knob toward the left to select "Up." 6. Press the [L] knob to confirm.

English

日本語

Deutsch

Français

Italiano

Español

Português

Nederlands

简体中文

Recording Your Performance

Recording Your Keyboard Performance

You can record your own keyboard performance, and then play back to check it.

Getting Ready to Record

1. Select the tone that you want to play.

2. You can sound the metronome if you like.

Set the metronome's tempo and time signature. The metronome setting is stored in the song, and you can use the same settings during playback.

3. Press the [●] button.

The [●] button lights, the [▶/■] button blinks, and the piano enters record-standby mode.

If you decide to cancel recording, press the [●] button once again.

Starting/Stopping Recording

4. Press the [▶/■] button.

After a one-measure count, recording starts, and the [●] button and [▶/■] button are both lit. The performance is saved automatically.

MEMO

You can also start recording by playing the keyboard instead of pressing the [▶/■] button. In this case, a count is not sounded.

5. To stop recording, press the [▶/■] button once again.

Recording stops.

Listening to the Recorded Performance

6. Press the [▶/■] button.

After you record, the newly recorded song is selected.

The recorded song starts playing back.

Deleting a Saved Song

You can delete a song that you saved.

MEMO

- You can also delete a recorded song by holding down the [●] button and pressing the [↵] button.
- If you want to delete all songs that have been saved to internal memory, initialize the memory ("Initializing the Memory (Format Media)" (p. 33)).

1. Press the [⚙] button.

The [⚙] button is lit, and the piano is in function mode.

2. Turn the [↓] knob to access the "Delete Song" screen.

3. Press the [↓] knob to confirm.

The "Delete Song - Media" screen appears.



4. Turn the [↓] knob to select the media that contains the song you want to delete, and press the [↓] knob to confirm.

5. Turn the [↓] knob to select the song that you want to delete, and press the [↓] knob to confirm.

A confirmation message appears.

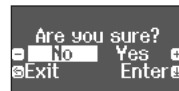

If you decide to cancel, press the [↵] button.

6. Turn the [↓] knob to select "Yes," and press the [↓] knob to confirm.

The deletion is executed.

7. Press the [⚙] button.

You exit function mode.

Managing Songs You Recorded

You can rename a saved song.

1. Press the [⚙] button.

The [⚙] button is lit, and the piano is in function mode.

2. Turn the [↓] knob to access the "Rename Song" screen.

3. Press the [↓] knob to confirm.

The "Rename Song - Media" screen appears.



4. Turn the [↓] knob to select the media that contains the song you want to rename, and press the [↓] knob to confirm.

5. Turn the [↓] knob to select the song that you want to rename, and press the [↓] knob to confirm.

6. Rename the song.

	Operating the Unit
Select the character which you want to change	Turn the [↓] knob
Change the character	Press the [↓] knob (confirm) → Turn the [↓] knob (change the character) → Press the [↓] knob (back)
Insert one character	Press the [▶/■] button
Delete one character	Press the [●] button

7. Turn the [↓] knob to select the ✓ at the right edge of the screen, and then press the [↓] knob to confirm.

A confirmation message appears.

8. Turn the [↓] knob to select "Yes," and press the [↓] knob to confirm.

The song is renamed.

* Never turn off the power or disconnect the USB flash drive while the screen indicates "Executing.."

9. Press the [⚙] button.

You exit function mode.

Copying a Recorded Song

Songs that have been saved in internal memory can be copied to USB flash drive. Alternatively, songs stored on a USB flash drive can be copied to internal memory.

1. Press the [F] button.

The [F] button is lit, and the piano is in function mode.

2. Turn the [D] knob to access the “Copy Song” screen, and press the [D] knob to confirm.

3. Press the [D] knob to confirm.

The “Copy Song - Media” screen appears.

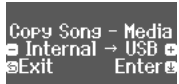

4. Turn the [D] knob to select the copy-source and copy-destination media, and press the [D] knob to confirm.

5. Turn the [D] knob to select the song that you want to copy.

If you decide to cancel, press the [ESC] button.

6. Press the [D] knob.

The copy is executed.

* Never turn off the power or disconnect the USB flash drive while the screen indicates “Executing...”

7. Press the [F] button.

You exit function mode.

Advanced Recording Methods

Recording Your Performance One Hand at a Time

By recording your left-hand performance to the Left part and your right-hand performance to the Right part, you can record each hand of your performance separately.



Left (or right) part

Getting ready to record

1. Select the tone that you want to play.

2. You can sound the metronome if you like.

Set the metronome's tempo and time signature. The metronome setting is stored in the song, and you can use the same settings during playback.

3. Press the [RECORD] button.

The [RECORD] button lights, the [PLAY/PAUSE] button blinks, and the piano enters record-standby mode.

If you decide to cancel recording, press the [RECORD] button once again.

4. Press the [PART] button and turn the [D] knob to select the part that you don't want to record; then press the [D] knob to make it go dark.

Only the part that you're recording will blink.

MEMO

If you don't select a part at this time, your performance is recorded to the following parts.

Performing with one tone	“Right” part
Performing different tones with the left and right hands (Split Play)	The left-hand tone is the “Left” part, and the right-hand tone is the “Right” part
Performing with two tones layered (Dual Play)	The tone 1 is the “Right” part, and the tone 2 is the “Accomp” part

Starting/stopping recording

5. Press the [PLAY/PAUSE] button.

After a one-measure count, recording starts, and the [RECORD] button and [PLAY/PAUSE] button are both lit. The performance is saved automatically.

MEMO

You can also start recording by playing the keyboard instead of pressing the [PLAY/PAUSE] button. In this case, a count is not sounded.

6. To stop recording, press the [PLAY/PAUSE] button once again.

Recording stops.

Overdubbing a Recorded Performance

After recording one hand of your performance, you can overdub-record the performance of the other hand.

You can also overdub-record onto a built-in song.

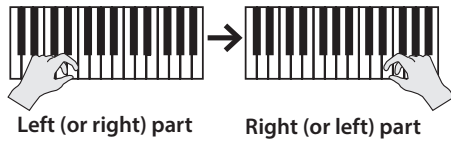

Getting ready to record

1. Press the [] button.

The Song screen appears.

2. Turn the [] knob to select the category of the song that you want to overdub, and press the [] knob to confirm.

3. Turn the [] knob to select the song that you want to overdub.

You can select songs within the category.

MEMO

If you're recording your performance along with a built-in song, you can fix the tempo of the built-in song (p. 23).

4. Press the [] button.

The [] button lights, the [] button blinks, and the piano enters record-standby mode.

If you decide to cancel recording, press the [] button once again.

5. Turn the [] knob to access the "Overdub" screen.

The song of step 3 is selected.

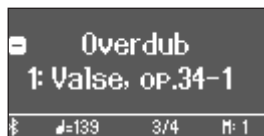

6. Press the [] button and turn the [] knob to select the part that you don't want to record; then press the [] knob to make it go dark.

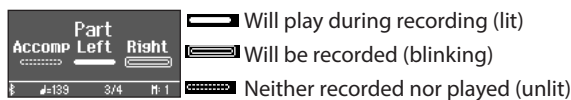

Starting/stopping recording

7. Press the [] button.

After a one-measure count, recording starts, and the [] button and [] button are both lit. The performance is saved automatically.

MEMO

You can also start recording by playing the keyboard instead of pressing the [] button. In this case, a count is not sounded.

8. To stop recording, press the [] button once again.

Recording stops.

Recording Audio to USB Flash Drive

If you audio-record your performance, you'll be able to listen to it on your computer or audio player, use it to create a music CD, or publish it on the internet.

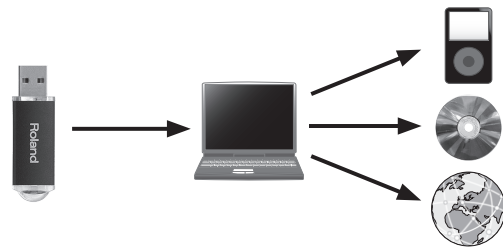

Getting ready to record

1. Connect your USB flash drive to the USB Memory port.

* Audio data can't be saved in the piano's internal memory.

* Never turn off the power or disconnect a USB flash drive or the power cord while the USB flash drive is blinking.

2. Select the tone that you want to play.

3. Hold down the [] button and turn the [] knob to select "Audio."

MEMO

You can also specify this via the Function mode "Recording Mode" setting (p. 36).

4. Press the [] button.

The [] button lights, the [] button blinks, and the piano enters record-standby mode.

If you decide to cancel recording, press the [] button once again.

5. You can sound the metronome if you like.

Starting/stopping recording

6. Press the [] button.

Recording starts, and the [] button and [] button are lit. The performance is saved automatically.

NOTE

Never turn off the power or disconnect the USB flash drive during recording.

7. To stop recording, press the [] button once again.

Recording stops.

MEMO

- You can delete a song (p. 24).
- You can rename a song (p. 24).

Creating Your Own Piano Tone (Piano Designer)

This piano lets you adjust various elements of the sound, so you can personalize the piano tone to your taste. This function is called “Piano Designer.”

MEMO

The process of creating your own piano tone can also be done using touch operations on the dedicated app.

➔ “Using the Piano with an App” (p. 30)



App “Piano Designer”

Adjusting the Sound of the Overall Piano

1. Press the [⚙️] button.

The button is lit, and the piano is in function mode.

2. Turn the [↕] knob to access the screen of the item that you want to adjust.

3. Press the [↕] knob to confirm.

4. Turn the [↕] knob to choose the value of the setting.

5. To exit the setting, press the [⚙️] button to exit function mode.

Item	Value	Explanation
Master Tuning	415.3Hz–466.2Hz (default value: 442.0Hz)	When playing in an ensemble with other instruments, you can adjust the reference pitch of this piano so that you will harmonize correctly with the other instruments. The reference pitch is usually expressed as the frequency that is heard when you play the middle A (A4) note. The action of matching the reference pitch to other instruments is called “tuning.”
Temperament	You can play classical styles such as Baroque using historic temperaments (tuning methods). Most modern songs are composed for and played in equal temperament, the most common tuning in use today. But at one time, there were a wide variety of other tuning systems in existence. By playing in the temperament that was in use when a composition was created, you can experience the sonorities of chords originally intended for that song.	
	Equal (default value)	This temperament divides the octave into twelve equal steps. It is the temperament that is most commonly used on today’s pianos. Every interval has the same slight amount of dissonance.
	Just Major	In these temperaments, the primary triads are perfectly consonant. It is unsuited to playing melodies and cannot be transposed, but is capable of beautiful sonorities. The Just tunings differ from major and minor keys.
	Just Minor	
	Pythagorean	This tuning, devised by the philosopher Pythagoras, eliminates dissonance in fourths and fifths. Although triadic chords are slightly dissonant, this tuning is suitable for songs that have a simple melody.
	Kirnberger I	As in the Just temperaments, the primary triads are consonant in this tuning. Beautiful sonorities are obtained when playing songs that are written in keys appropriate for this tuning.
	Kirnberger II	This is a revision of Kirnberger I that reduces the limitations on the usable keys.
	Kirnberger III	This is an improvement of the Meantone and Just tunings that provides a high degree of freedom of modulation. Performances are possible in all keys. Since the resonance differs depending on the key, chords played in this temperament resonate in diverse ways when compared to equal temperament.
	Meantone	This temperament slightly narrows the fifth relative to Just temperaments. While the Just temperaments contains two types of whole tone (major whole tone and minor whole tone), meantone temperament uses only one type of whole tone (mean whole tone). Transposition within a limited range of keys is possible.
	Werckmeister	This temperament consists of eight perfect fifths and four narrowed fifths. Performance in all keys is possible. Since different keys produce different sonorities, chords will resonate in diverse ways when compared to equal temperament (Werckmeister I (III)).
Arabic	This tuning is suitable for the music of Arabia.	
Temperament Key	C–B (default value: C)	When playing with tuning other than equal temperament, you need to specify the temperament key for tuning the song to be performed (that is, the note that corresponds to C for a major key or to A for a minor key). If you choose an equal temperament, there’s no need to select a temperament key.
Hammer Response	Off, 1–10 (default value: 1)	Adjusts the time from when you play the key until the piano sound is heard. Higher values produce a greater delay.

Editing the Grand Piano Tone

You can adjust various aspects of the grand piano's tone, including the string and pedal resonances, and the sound of the hammers striking the strings.

* These adjustments are possible only for the grand piano tone category of the  button.

1. Press the [G] button.

The button is lit, and the piano is in function mode.

2. Turn the [L] knob to access the "piano designer" screen.

3. Press the [L] knob to confirm.

4. Turn the [L] knob to access the screen of the item that you want to edit.

5. Press the [L] knob to confirm, and turn the [L] knob to choose the value of the setting.

6. When you are finished editing the piano tone, press the [B] button.

A confirmation message appears.



If you decide to cancel, press the [B] button.

7. Turn the [L] knob to select "Yes," and press the [L] knob to confirm.

The Grand Piano tone settings are saved.

Piano tone settings

Item	Value	Explanation
Lid	0-6	Adjusts the extent to which the top lid of the grand piano is open. The sound will become more mellow as you close the top lid of the piano in the screen. The sound will become brighter as you open the top lid of the piano in the screen.
String Resonance	Off, 1-10	Adjusts the string resonance of the acoustic piano (the sound of the strings of already-pressed notes vibrating in sympathy with the notes you play, and the sound of the strings of unplayed notes also vibrating in sympathy if the damper pedal is pressed). Higher settings produce louder sympathetic resonance.
Damper Resonance	Off, 1-10	Adjusts the overall resonance of the acoustic piano when its damper pedal is pressed (the sound of other strings vibrating in sympathy when you press the damper pedal, and the resonance of the entire instrument). Higher settings produce louder sympathetic resonance.
Key Off Resonance	Off, 1-10	Adjusts the resonance of the subtle sounds that occur when a key of an acoustic piano is released. A higher value produces a larger tonal change during the decay.
Single Note Tuning (*)	-50-0-+50	Adjusts the tuning of each individual key. For example, you can adjust the width of stretched tuning, which tunes the higher register slightly higher and the lower register slightly lower.
Single Note Volume (*)	-50-0	Adjusts the volume of each key. Lower settings decrease the volume.
Single Note Character (*)	-5-0-+5	Adjusts the tonal character of each key. Higher settings produce a harder sound, and lower settings produce a softer tone. * The result of this effect will differ depending on the pitch range.
Reset Setting	Resets the "Piano Tone Edit" settings of the selected tone to their factory settings.	

(*) Single Note settings

1. Select the Single Note settings screen, and press the [L] knob to confirm.

2. Play the key for which you want to make adjustments, and turn the [L] knob to change the value.

3. Press the [B] button to exit the screen of that item.

Connecting the Piano and a Mobile Device via Bluetooth



By using the Bluetooth function, you can wirelessly connect the piano with a mobile device such as your smartphone or tablet, allowing you to do the following things.

➔ Together with this section, you should also read the Quick Operation section's "Connecting a Mobile Device via Bluetooth" (p. 15).

Play Music Through the Piano's Speakers (Bluetooth Audio)

A song played back on your mobile device can be heard wirelessly through the piano's speakers.

Pairing

As an example, we explain how to make settings from function mode using an iOS device.

1. Place the mobile device that you want to connect near the piano.

2. Press the piano's [⚙️] button.

The [⚙️] button is lit, and the piano is in function mode.

3. Turn the [↕] knob to access the "Bluetooth" screen, and press the [↕] knob to confirm.

The following screen appears.



4. Press the [↕] knob to begin pairing.



If you decide to cancel pairing, press the [↩] button.

MEMO

You can also begin pairing directly by long-pressing the piano's [⚙️] button.

5. Turn on the Bluetooth function of the mobile device.

6. Tap "RP701 Audio" or "F701 Audio," that appears in the mobile device's Bluetooth "DEVICES" field.

The piano and mobile device are paired. When pairing is completed, a display like the following appears.

Mobile device	"RP701 Audio" or "F701 Audio" are added in the "My Devices" field
Piano	The screen indicates "Completed," and "AUDIO" is shown beside the Bluetooth symbol 

7. Press the piano's [⚙️] button to exit function mode.

Pairing is complete.

Playing back audio

When you play back music data on the mobile device, the sound is heard from the piano's speakers.

MEMO

To adjust the volume of the audio, make adjustments on your mobile device. If this does not produce the desired volume, you can adjust the piano's settings.

➔ "Input/Bluetooth Vol." (p. 34)

Connecting an already-paired mobile device

If the mobile device has already been paired with the piano, there is no need to perform pairing again the next time. Simply turn on the Bluetooth function of the mobile device, and it will reconnect with the piano.

* If the above step does not establish a connection, tap "RP701 Audio" or "F701 Audio" that are shown in the "DEVICES" field of the mobile device.

English

日本語

Deutsch

Français

Italiano

Español





Português

Nederlands

简体中文

Using the Piano with an App (Bluetooth MIDI)

Apps that can be used with this piano

App name	Supported OS	Explanation
 Roland Piano App	iOS iPadOS Android	This app lets you view sheet music in digital form, practice songs as if you were playing a game, or keep a record of your practicing. 
 Piano Designer	iOS Android	This app lets you customize the piano sound to your taste. It provides touch-based editing within the app for the various elements of the sound in "Creating Your Own Piano Tone (Piano Designer)" (p. 27). 

- * Apps can be downloaded from the App Store or Google Play (free of charge).
- * In addition to the above, you can also use music apps (such as Garage Band) that are compatible with Bluetooth MIDI.
- * The information provided about apps made by Roland was current when this manual was published. For the latest information, refer to the Roland website.

Making Settings (Pairing)

You can make settings for using the piano together with an app that's installed on your mobile device. As an example, we'll explain the procedure for using an iPad with the "Roland Piano App" app.

- * In the case of "using the piano with an app," settings on the piano are not necessary. Perform operations in the app to pair it with the piano.

1. Turn on the Bluetooth function of the mobile device.

NOTE

Even if the "DEVICES" field shows the name of the device you're using (such as "RP701 MIDI"), do not tap it.

2. Start the app that you installed on your mobile device.

3. Tap "Connect piano".

The app screen shows "RP701 MIDI" or "F701 MIDI".

4. Tap either "RP701 MIDI" or "F701 MIDI" depending on the unit that you're using.

The piano and mobile device are paired. When pairing is completed, a display like the following appears.

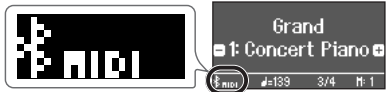
Mobile device	"Connected with RP701 MIDI or F701 MIDI" appears in the "Connection" area at the top of the app screen.
Piano	The "MIDI" is shown beside the Bluetooth symbol 

MEMO

When connecting to a mobile device for which you've initialized the settings, the device automatically connects when you launch the app. The connection may take several seconds.

- * If the piano doesn't connect with your mobile device, tap "Connection" at the top of the app screen, and then tap "Connect to Piano".

If Pairing Does Not Succeed in "Using the Piano with an App"

1 Make sure that the piano's Bluetooth function is "On."

1. Press the piano's [⚙️] button.
The button is lit, and the piano is in function mode.
2. Turn the [↕] knob to access the "Bluetooth" screen, and then press the [↕] knob to confirm.
The Bluetooth setting screen appears.
3. Turn the [↕] knob to access the "Bluetooth on/off" screen, and then press the [↕] knob to confirm.
4. Turn the [↕] knob to select "on."
The piano's Bluetooth function turns on.
5. Press the [⚙️] button.
The button goes dark, and you exit function mode.

2 Exit all apps on your mobile device.

Closing the app

1. Double-click the home button, and swipe up on the app screen.

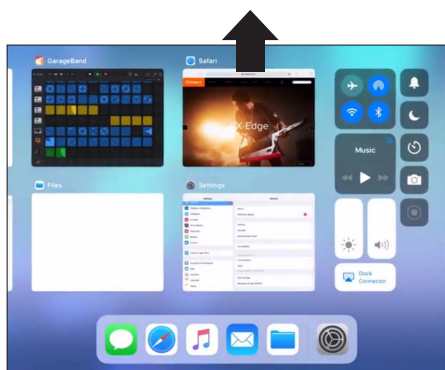

3 If already paired, cancel pairing, and turn off the Bluetooth function.

Clearing the pairing

1. In the mobile device's screen, tap the "i" located beside "Connected," and tap "Forget This Device."

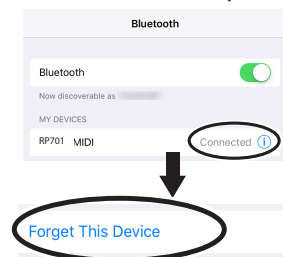

2. Turn the Bluetooth switch off.

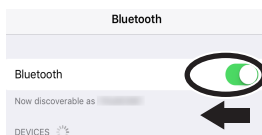

4 Perform the pairing procedure of p. 30 from step 1.

MEMO

If checking these points does not solve the problem, please refer to the Roland support website.

<https://www.roland.com/support/>

If you have more than one piano

When pairing with a mobile device in a situation where there are multiple pianos, such as in a music classroom, you can assign an ID to each piano.

Assigning an ID

When you make this setting, an ID number is added to the end of the device name that's shown on the mobile device. (such as "RP701 Audio" "RP701 MIDI 1")

1. Press the [⚙️] button.
2. Access the "Bluetooth" screen, and press the [↕] knob to confirm.
3. Turn the [↕] knob to select "Bluetooth ID."
4. Press the [↕] knob to confirm, and turn the [↕] knob to change the number.

RP701

ID	Explanation
0-99	Set to "0": "RP701 Audio" "RP701 MIDI" (default value)
	Set to "1": "RP701 Audio 1" "RP701 MIDI 1"

F701

Value	Explanation
0-99	Set to "0": "F701 Audio" "F701 MIDI" (default value)
	Set to "1": "F701 Audio 1" "F701 MIDI 1"

* If you are pairing in an environment where there are multiple pianos, we recommend that you turn on the power of the mobile device and only those pianos that you want to pair (turn off the power of other devices).

Convenient Functions

Loading/Saving Piano Setups

You can save your own piano settings in a USB flash drive, or load them into the other digital piano.

* Settings can be loaded only into another piano of the same model.

Settings that are saved

Setting	Page
Speaker volume	p. 6, p. 10
Headphone volume	p. 7, p. 11
Ambience	p. 22
Brilliance	p. 22
Headphones 3D Ambience	p. 22
Key Touch	p. 22
Master Tuning	p. 27
Temperament	p. 27
Temperament Key	p. 27
Hammer Response	p. 27
Piano Tone settings	p. 28
Volume Limit	p. 37

Saving Piano Settings (Piano Setup Export)

1. Connect your USB flash drive to the USB Memory port.

2. Press the [⚙️] button.

The button is lit, and the piano is in function mode.

3. Turn the [↶] knob to access “Piano Setup Export” screen, and then press the [↶] knob.

The Piano Setup Export screen appears.

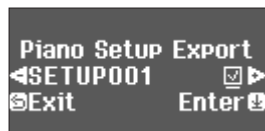

4. Rename the piano settings.

Select the character which you want to change	Turn the [↶] knob
Change the character	Press the [↶] knob (confirm) → Turn the [↶] knob (change the character) → Press the [↶] knob (back)
Insert one character	Press the [▶/■] button
Delete one character	Press the [●] button

5. Turn the [↶] knob to select the ✓ at the right edge of the screen, and then press the [↶] knob to confirm.

The settings are saved.

NOTE

Never turn off the power or remove the USB flash drive while the screen indicates “Executing...”

6. Press the [⚙️] button to exit function mode.

The button goes dark.

Loading Piano Settings (Piano Setup Import)

1. Connect your USB flash drive to the USB Memory port.

2. Press the [⚙️] button.

The button is lit, and the piano is in function mode.

3. Turn the [↶] knob to access “Piano Setup Import” screen, and then press the [↶] knob.

The Piano Setup Import screen appears.



4. Turn the [↶] knob to select the piano settings that you want to load.

5. Press the [↶] knob to confirm.

A confirmation message appears.

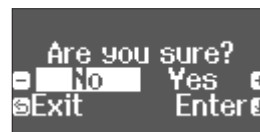

If you decide to cancel, press the [↷] button.

6. Turn the [↶] knob to select “Yes,” and press the [↶] knob to confirm.

The settings are loaded.

NOTE

Never turn off the power or remove the USB flash drive while the screen indicates “Executing...”

7. Press the [⚙️] button to exit function mode.

The button goes dark.

Initializing the Memory (Format Media)

Here's how to erase all of the files that you saved in internal memory or on a USB flash drive (commercially available).

NOTE

- When you initialize, all registrations or files that you saved in internal memory or on a USB flash drive are lost.
- If you want settings other than the memory settings to be returned to their factory-set state, execute a Factory Reset (p. 33).

1. If you want to initialize a USB flash drive, connect the USB flash drive to the USB Memory port.

2. Press the [F] button.

The button is lit, and the piano is in function mode.

3. Turn the [L] knob to access "Format Media" screen, and then press the [L] knob.

The Format Media screen appears.



If you decide to cancel, press the [C] button.

4. Turn the [L] knob to select the media (Internal Memory or USB Memory) that you want to format.

5. Press the [L] knob to confirm.

A confirmation message appears.

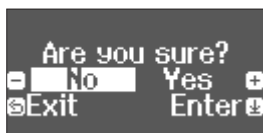

If you decide to cancel, press the [C] button.

6. Turn the [L] knob to select "Yes," and press the [L] knob to confirm.

The memory is formatted.

NOTE

Never turn off the power or remove the USB flash drive while the screen indicates "Executing..."

7. Press the [F] button to exit function mode.

The button goes dark.

Restoring the Factory Settings (Factory Reset)

Here's how to restore all registrations and internally saved settings to the factory-set condition. This function is called "Factory Reset."

NOTE

Factory Reset erases all settings that you have stored, and returns them to the factory-set condition. For details on the settings that are reset, refer to "Settings Saved Even If the Power Is Turned Off" (p. 38).

MEMO

Executing this function does not erase the files in internal memory or on a USB flash drive (commercially available). If you want to erase all files from internal memory or from a USB flash drive, refer to "Initializing the Memory (Format Media)" (p. 33).

1. Press the [F] button.

The button is lit, and the piano is in function mode.

2. Turn the [L] knob to access "Factory Reset" screen, and then press the [L] knob.

A confirmation message appears.

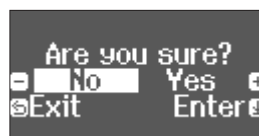

If you decide to cancel, press the [C] button.

3. Turn the [L] knob to select "Yes," and press the [L] knob to confirm.

The memory is reset to its factory values.

NOTE

Never turn off the power or remove the USB flash drive while the screen indicates "Executing..."

4. Turn the power off, then on again.

Disabling the Buttons (Panel Lock)

To prevent settings from being accidentally changed while you perform, you can disable all buttons other than the [P] button and the [Volume] buttons.

Lock the panel	Hold down the [M] button until the screen shows the "🔒" symbol.
Unlock the panel	Hold down the [M] button until the "🔒" symbol disappears.



Making Various Settings (Function Mode)

Basic Settings in Function Mode

1. Press the [⚙️] button.

The button is lit, and the piano is in function mode.

2. Turn the [↻] knob to access the screen of the item you want to set.

3. Press the [↻] knob to confirm.

* Depending on the item you select, there might be another screen for selecting additional items.

4. Turn the [↻] knob to change the value.

5. Press the [⚙️] button to exit function mode.

The button goes dark.

Indication	Value	Explanation
Bluetooth-related settings		
Bluetooth	Bluetooth On/Off	<p>Turning the Bluetooth Function On/Off (Bluetooth On/Off)</p> <p>If the Bluetooth function is on, you'll be able to wirelessly connect the piano and your mobile device, so that music played back from the mobile device can be heard through the piano's speakers, or so that you can use the piano with an app. (p. 29)</p> <p>On, Off</p>
	Bluetooth Pairing	Perform the pairing to wirelessly connect the piano and mobile device for "Playing Music Through the Piano's Speakers." (p. 29)
	Input/Bluetooth Vol.	<p>Adjusting the Volume of Bluetooth Audio (Input/Bluetooth Vol.)</p> <p>This is the volume setting for playing music from your mobile device through the piano's speakers. (p. 16)</p> <p>0-10</p>
	Bluetooth ID	<p>If you are using the Bluetooth function in a location where there are multiple pianos, you can assign a separate ID to each piano. (p. 31)</p> <p>0-99</p>
Settings related to the sound and keyboard		
Key Touch	➔	"Changing the keyboard touch sensitivity" (p. 22)
Ambience	➔	"Adjusting the sound's ambience and brightness" (p. 22)
Headphones 3D Ambience	➔	"Adjusting the sound's ambience and brightness" (p. 22)
Brilliance	➔	"Adjusting the sound's ambience and brightness" (p. 22)
Master Tuning	➔	"Creating your own piano tone (Piano Designer)" (p. 27)
Temperament		
Temperament Key		
Hammer Response		
Piano Designer		



Indication	Value	Explanation	
Keyboard Mode	Whole	This is the same keyboard setting as a conventional acoustic piano.	
	Split	Playing Different Tones with the Left and Right Hand (p. 21)	
		Right Tone	Selects the right-hand tone.
		Left Tone	Selects the left-hand tone.
		Point	Selects the location (key) at which the left and right tones are divided.
		Balance	Selects the volume balance between the left-hand tone and right-hand tone.
		Left Shift	Raises or lowers the pitch of the left-hand tone in one-octave steps.
		Right Shift	Raises or lowers the pitch of the right-hand tone in one-octave steps.
	Dual	Playing Two Tones Layered on Each Key (p. 21)	
		Tone 1	Selects tone 1.
		Tone 2	Selects tone 2.
		Balance	Selects the volume balance of the two tones.
		Tone 1 Shift	Raises or lowers the pitch of tone 1 in one-octave steps.
		Tone 2 Shift	Raises or lowers the pitch of tone 2 in one-octave steps.
Twin Piano	Dividing the Keyboard for Two People (Twin Piano)		
	You can divide the keyboard into left and right areas so that two people can play the same range of pitches. One person can play a model performance, and the other person can practice along with that model performance. You can also change the way (Mode) in which notes are sounded in Twin Piano.		
	Off	The same keyboard setting as a conventional acoustic piano.	
	On	Mode	To select the mode for Twin Piano, select "On" in the Twin Piano screen of function mode, and then perform the following procedure. (1) Press the [≡] button twice to access the "Twin Piano" screen (2) Press the [±] knob to make "-" "+" appear at the left and right of "Tone" in the screen (3) Turn the [±] knob toward the right to access the "Mode" screen (4) Press the [±] knob to confirm, and turn the [±] knob to select either "Pair" or "Individual"
			Pair
Individual			Notes played in the right area are heard only from the right speaker; notes played in the left area are heard only from the left speaker.
Kbd Transpose	Raises or lowers the pitch range of the keyboard in semitone steps. When you are accompanying a singer or performing as a vocalist-instrumentalist, this setting lets you match the vocal range of the singer without having to change your keyboard fingering.		
	-6-0+5		
Settings related to song playback			
Song Transpose	Transposing the Pitch of the Song Playback (Song Transpose)		
	You can transpose the song playback in semitone steps. (p. 23) -12-0+12		
Song Volume SMF	Adjusting the Song (SMF) Volume (Song Volume SMF)		
	This setting adjusts the volume of your keyboard performance while a song plays back. This adjusts the volume of the song (SMF data) that is played back. 0-10		
Song Volume Audio	Adjusting the Song (Audio) Volume (Song Volume Audio)		
	This setting adjusts the volume of your keyboard performance while a song plays back. This adjusts the volume of the song (audio data) that is played back. 0-10		

English

日本語

Deutsch

Français

Italiano

Español

Português

Nederlands

简体中文

Indication	Value	Explanation
Input/ Bluetooth Vol.	Adjusting the Volume of an Audio Playback Device (Input/Bluetooth Vol.)	
	This setting adjusts the volume of your keyboard performance while a song plays back. You can adjust the volume of an audio playback device that's connected to the Input jacks. 0-10	
USB Audio Input Vol.	Adjusting the Volume from the Computer (USB Audio Input Volume)	
	This setting adjusts the volume from the computer when you're playing back audio from a computer connected to the USB Computer port. 0-10	
SMF Play Mode	Setting the Song (SMF) Playback Mode (SMF Play Mode)	
	This setting specifies the tone that you play on the keyboard while a song is playing back. Normally you will use the "Auto-Select" setting. This determines whether the setting that is most suitable for the internal song or most suitable for external data is selected when you play back a song whose file format is SMF. Changing this setting does not affect the sound character of tone that you play from the keyboard. * You can also switch the SMF Play Mode by holding down the [▶/■] button and turning the [⏏] knob.	
	Auto-Select	Automatically switches the SMF Play Mode to either "Internal" or "External" depending on the song that is being played.
	Internal	When you play back a song, the tone that you play from the keyboard changes to the tone that is saved in the song. This is recommended when you play back an internal song or a song that you recorded on this piano.
External	The tone that you play from the keyboard does not change when you play back a song. This is recommended when you play back external data such as commercially available music data. * With this setting, some effects might not apply to the song playback sound. For this reason, the character of the sound during playback might be different than the sound while you were recording.	
Recording-related settings		
Recording Mode	This piano lets you record in two different modes. You can choose whether to record as SMF or as audio. * You can also switch recording modes by holding down the [●] button and turning the [⏏] knob.	
	SMF	Your performance is recorded to "Internal Memory" and played back on the piano. You can overdub your left-hand performance onto your right-hand performance, and then listen to the playback of both hands together. (p. 24)
	Audio	Your performance is recorded to a USB flash drive as audio data. You can listen to your recorded piano performance on a computer or audio player, use it to create a CD, or publish it on the internet. (p. 26)
Delete Song	Deletes a song that was saved in the piano's internal memory or on a USB flash drive. (p. 24)	
Rename Song	Renames a saved song. (p. 24)	
Copy Song	Songs that have been saved in internal memory can be copied to USB flash drive. Alternatively, songs stored on a USB flash drive can be copied to internal memory. (p. 25)	
Count-in Measure	You can change the number of measures that are sounded as a count before song playback or recording begins.	
	1 Measure, 2 Measures	
Pedal-related settings		
Damper Pedal Part	Changing How the Pedal Effects Are Applied (Damper Pedal Part)	
	When you press the right pedal while using Dual Play or Split Play (p. 7, p. 11) the pedal effect is applied to both tones, but you can choose the tone to which the effect is applied.	
	Right & Left	All enabled
	Right	Applied only to the Tone 1 (in dual mode)/Right-hand Tone (in split mode)
Left	Applied only to the Tone 2 (in dual mode)/Left-hand Tone (in split mode)	
Center Pedal	Changing How the Pedals Work (Center Pedal)	
	When you turn on the power, the center pedal functions as the sostenuto pedal (p. 7, p. 11). You can change the function of the pedal to a variety of other operations. By assigning a function to the pedal, you can instantly change a setting by pressing the pedal while you perform.	
	Sostenuto	The pedal functions as a sostenuto pedal.
	Play/Stop	The pedal has the same function as the [▶/■] button.
Layer	Pressing the pedal will layer on Tone 2, used for Dual Play. * This is available only when using Dual Play.	

Indication	Value	Explanation
Left Pedal	Changing the Effect of the Pedal (Left Pedal)	
	When you turn on the power, the left pedal functions as a soft pedal (p. 7, p. 11). You can change the function of the pedal to a variety of other operations. By assigning a function to the pedal, you can instantly change a setting by pressing the pedal while you perform.	
	Sostenuto	The pedal functions as a sostenuto pedal.
	Play/Stop	The pedal has the same function as the [▶/■] button.
	Layer	Pressing the pedal will layer on Tone 2, used for Dual Play. * This is available only when using Dual Play.
MIDI-related settings		
Local Control	Preventing Doubled Notes When Connected to a Sequencer (Local Control)	
	When you have a MIDI sequencer connected via USB, set this parameter to Local Off. Since most sequencers have their Thru function turned on, notes you play on the keyboard may be sounded in duplicate, or get dropped. To prevent this, you can enable the "Local Off" setting so that the keyboard and internal sound generator will be disconnected.	
	Off	Local Control is off. The keyboard is disconnected from the internal sound generator. Playing the keyboard will not produce sound.
	On	Local Control is on. The keyboard is connected to the internal sound generator.
MIDI Transmit Ch.	MIDI Transmit Channel Settings (MIDI Transmit Ch.)	
	This setting specifies the MIDI channel on which the unit will transmit. This unit will receive all sixteen channels (1–16).	
	Off, 1–16	
Overall operation settings		
Language	Changing the Language Displayed in the Screen (Language)	
	You can change the language that is displayed in the screen. English, Japanese, Chinese	
Display Contrast	Adjusting the Brightness of the Display (Display Contrast)	
	You can adjust the brightness of the display. 1–10	
Screen Saver	Specifying the Time Until the Operating Panel Dims (Screen Saver)	
	When no operation has been performed for a specified length of time, the display will go blank and the operating panel button LEDs will go dark. The display reappears when you perform an operation. You can specify the time until the panel goes dark.	
	Off, 30 sec., 1 min. (default value), 5 min., 10 min.	
Volume Limit	Specifying a Maximum Volume (Volume Limit)	
	You can specify a maximum volume value. This lets you prevent loud sound from being produced unintentionally. MEMO	
	You can also set the volume limit by turning the [↕] knob while holding down the [⏏] button and the [⏏] button. 20, 40, 60, 80, 100	
Speaker Auto Mute	Outputting Sound Both from Headphones and Internal Speakers (Speaker Auto Mute)	
	With the factory settings, sound is no longer output from the internal speaker when you connect headphones to the PHONES jack. However, you can change this setting so that sound is output both from the headphones and from the internal speakers. * If this is "Off," the sound that is output from the headphones will have a different character.	
	Off	Sound is heard both from headphones and the internal speakers.
	On	Sound is heard only from the headphones (default value).

English

日本語

Deutsch

Français

Italiano

Español

Português

Nederlands

简体中文

Making Various Settings (Function Mode)

Indication	Value	Explanation
Auto Off	Making the Power Automatically Turn off After a Time (Auto Off)	
	With the factory settings, the unit's power will automatically be switched off 30 minutes after you stop playing or operating the unit. If you don't want the power to turn off automatically, change the "Auto Off" setting to "Off" as follows. Off, 10, 30, 240 (min)	
Auto Memory Backup	Saving Settings Automatically (Auto Memory Backup)	
	You can make settings be saved automatically so that the settings will not change when you turn the power off and on again.	
	Off	Settings are not saved.
	On	The settings are saved automatically. This is convenient, since you don't need to make the settings each time you turn on the power. For details on the settings that are saved, refer to "Settings that are saved by "Auto Memory Backup"" (p. 38).
Piano Setup Export	You can save your own piano settings in a USB flash drive, or load them into the other digital piano. (p. 32)	
Piano Setup Import	* Settings can be loaded only into another piano of the same model.	
Format Media	All files saved in the piano's internal memory or on a USB flash drive (commercially available) can be deleted. (p. 33)	
Factory Reset	Settings saved in the piano can be returned to their factory-set state. (p. 33)	
Version	Displays the version of the unit's system program. If a new system program becomes available, it can be used to update your piano. For details, refer to the following URL. http://www.roland.com/support/ Enter the model name → refer to "Updater and Driver"	

Settings Saved Even If the Power Is Turned Off

This piano remembers the "settings that are saved automatically" even when the power is turned off and then on again. If you set the "Auto Memory Backup" setting, the settings saved by "auto memory backup" are also saved. Other settings return to their default values when you turn the power off and on again.

Settings that are saved automatically

This piano automatically saves the following settings. These settings are remembered even if the power is turned off.

Setting	Page
Speaker volume	p. 6, p. 10
Headphone volume	p. 7, p. 11
Bluetooth On/Off	p. 34
Bluetooth ID	p. 34
Input/Bluetooth Vol.	p. 34
Auto Off	p. 38

Settings that are saved by "Auto Memory Backup"

If the "Auto Memory Backup" function (p. 38) is on, the following settings are saved.

Setting	Page
Ambience	p. 22
Brilliance	p. 22
Headphones 3D Ambience	p. 22

Setting	Page
Key Touch	p. 22
Master Tuning	p. 27
Temperament	p. 27
Temperament Key	p. 27
Hammer Response	p. 27
Balance (Split, Dual)	p. 21
Metronome (volume, tone, downbeat)	p. 22
Twin Piano Mode	p. 35
USB Audio Input Vol.	p. 36
SMF Play Mode	p. 36
Count-in Measure	p. 36
Damper Pedal Part	p. 36
MIDI Transmit Ch.	p. 37
Language	p. 37
Display Contrast	p. 37
Screen Saver	p. 37
Volume Limit	p. 37
Speaker Auto Mute	p. 37

Troubleshooting

Problem	Items to check	Cause/Action	Page
Problems with the piano's sound			
No sound	Is the volume turned down?	Raise the volume.	p. 6, p. 10
	Could headphones or an adaptor plug be inserted in the Phones jack?	If headphones or an adaptor plug are inserted in the headphones jack, sound is not output from the speakers.	-
	If you want sound to be produced from headphones or external speakers, is the device connected correctly?		p. 7, p. 11
	Could the "Local Control" setting be turned "Off"?	In function mode, turn the "Local Control" setting "On."	p. 37
Pitch of the keyboard or song is incorrect	Could you have made transpose settings?	In function mode, use the "Keyboard Transpose" and "Song Transpose" settings to defeat transposition.	p. 35
	Is the Master Tune setting appropriate?	When shipped from the factory, the reference pitch is set to "442.0 Hz." Check the "Master Tuning" setting of the Piano Designer function.	p. 27
	Is the setting for the Temperament correct?	When shipped from the factory, the tuning is set to "Equal temperament." Check the "Temperament" setting of the Piano Designer function.	p. 27
	Is the Single Note Tuning setting appropriate?	Check the Piano Designer function's "Single Note settings."	p. 28
Sounds are heard twice (doubled) when the keyboard is played	Could you have specified "Dual Play" which layers two tones?	In function mode, select "Kbd Mode" and change "Dual" to "Whole."	p. 35
	Could the piano be connected to an external sequencer?	If you don't want the piano to be played from another sound module, set your music production software's "soft thru" setting to "Off" If the function mode "Local Control" setting is "On," turn the "Local Control" setting "Off"	- p. 37
Reverberation remains even if you defeat the Ambience effect	This is because an acoustic piano's sense of depth and resonance is being faithfully simulated, and is not a malfunction. Even if you turn off the acoustic ambience effects, the distinctive resonance of an acoustic piano will remain.		-
The sound of the higher notes suddenly changes from a certain key	This simulates the characteristics of an acoustic piano, and is not a malfunction. The sound will change where there is a change in the number of strings per key or a transition from wound strings to unwound strings.		-
When you press a key, the sound of a note you didn't press is also faintly heard	In some cases, a note you play might cause a different note (whose frequency is an integer multiple of the first note) to resonate, producing the sensation that the sound has changed; this is not a malfunction.	Lower the Piano Designer's "String Resonance" value, or turn it off.	p. 28
High-pitched ringing is heard	<p>If you don't hear it through headphones: It may be that the piano has malfunctioned. Please contact your dealer or Roland support.</p> <p>If you also hear it through headphones: To decrease the metallic ringing, adjust the following settings.</p> <ul style="list-style-type: none"> •Ambience (p. 22) •Piano Designer "String Resonance" (p. 28) 		-
Low notes sound wrong, or are buzzy	Could the volume be set to maximum?	If the volume is at the maximum, the sound might be distorted depending on how you play the piano. If this occurs, lower the volume.	p. 6, p. 10
	<p>If you also hear it through headphones: It may be that the piano has malfunctioned. Please contact your dealer or Roland Support.</p> <p>If you don't hear it through headphones: Objects near the piano are resonating because of the high volume of sound coming from the speakers. You can take the following measures to minimize resonances.</p> <ul style="list-style-type: none"> • Keep the volume down. • Locate the speakers 10–15 cm (4–6 inch) away from walls or other surfaces. • Move away from the objects that are resonating. 		-
The sound is heard differently depending on the tone settings	When using "Dual play" which layers two tones, or "Split play" which produces different tones in the left-hand and right-hand, the sound might be heard differently depending on the specific combination. For some combinations, the effect is not applied to the left-hand tone or to tone 2, but this is not a malfunction.		-

English

日本語

Deutsch

Français

Italiano

Español

Português

Nederlands

简体中文

Troubleshooting

Problem	Items to check	Cause/Action	Page
Problems with the pedals			
Unusual sound is heard when you press the pedal	Could the adjuster located under the pedal not be in contact with the floor? (RP701)	The adjuster may have loosened as you used the pedal. Lower the adjuster so that it contacts the floor. If you are using the piano on carpet, lower the adjuster so that it presses strongly against the floor.	p. 7
Pedal does not work, or is "stuck"	Is the pedal connected correctly?	Check the pedal jack located on the bottom of the piano.	p. 20
	Could you have disconnected or connected the pedal cord while the power was on?	If you disconnect the pedal cord while the piano is powered-on, the pedal effect might remain applied. Connect or disconnect the pedal cord while the piano is powered off.	–
	Could you have changed the way in which the pedal effect is applied?	If the right pedal part is set to "Right," it applies only to the right-hand tone; if set to "Left," it applies only to the left-hand tone.	p. 36
	Could Twin Piano be turned on?	If Twin Piano is on, the right pedal will affect only the right-hand keyboard zone and the left pedal will affect only the left-hand keyboard zone.	–
	Could you have changed the function of the pedal?	If the function of the sostenuto pedal (center pedal) or the soft pedal (left pedal) have been changed, they will not operate as the sostenuto pedal or the soft pedal. Restore the settings of the "Center Pedal Function" and "Left Pedal Function."	p. 36, p. 37
Problems with song playback			
Only the sound of a particular instrument in a song does not play	When you press the [Part] button, are there parts (Right, Left, Accomp) that are unlit in the screen?	Parts that are not shown in the screen do not sound. Select an unlit part to highlight it so that it produces sound.	p. 13
Song volume is inaudible or too low	Could the Song volume be set too low?	Depending on the data format of the song, raise the "Song Volume SMF" or "Song Volume AUDIO" value.	p. 35
Changing the "Song Volume" does not change the volume	Could the SMF Play Mode be set to "Internal"?	Set the SMF Play Mode to "External."	p. 36
The selected sound changes when you play back a song	Could the SMF Play Mode be set to "Internal"?	Set the SMF Play Mode to "External."	p. 36
Can't play back a song saved in USB flash drive	Is the file extension ".WAV" or ".MP3" or ".MID"?	This piano can play back three types of file: WAVE format or MP3 format audio files, and MIDI files.	–
Names of songs saved on the USB flash drive do not appear in the screen	Does the file have a ".MID" extension? Could the song name information in the file be blank or consist only of spaces?	Song names can be shown in the screen only for files that have a ".MID" extension. If the song name information in the file is blank or consists only of spaces, the song name is not shown in the piano screen.	–
Problems with recording			
Can't record	When you press the [Part] button, is the part to be recorded blinking in the screen?	Select the part in the screen that you want to record, so that it blinks.	p. 25
Can't record audio	Is a USB flash drive connected to the USB Memory port?	Audio recording cannot be performed unless a USB flash drive is connected.	–
Volume differs between recording and playback	Could the Song Volume be set too low?	Depending on the data format of the song, raise the "Song Volume SMF" or "Song Volume AUDIO" value.	p. 35
The tonal character of the piano changes when you record	Could you be recording with a tone that you created in Piano Designer?	Some of the Piano Designer settings might not be reproduced when you play back a song.	–
	Could you be playing back a song that you audio-recorded to an USB flash drive?	If you want to record with the same tonal character as when you play the keyboard, record your performance as SMF.	–
Other problems			
Even though you're using headphones to mute the sound, a thumping sound is heard when you play the keyboard	The keyboard of this piano is designed to simulate the mechanism of an acoustic piano. Even on an acoustic piano, a thumping sound is actually being produced when you press a key. Such sounds do not indicate a malfunction.		–
Power turns off on its own	Could you have made settings so that the power automatically turns off when the piano has not been used for a time?	If you don't need the power to turn off automatically, turn the Auto Off setting "Off."	p. 38
Power does not turn on	Is the AC adaptor connected correctly?		p. 6, p. 10
The buttons of the operating panel do not work	Could you have enabled the "Panel Lock" setting to prevent inadvertent operation?	Disengage the "Panel Lock" setting.	p. 33
The volume level of the unit connected to Input jack is too low	Could the volume of the connected device be turned down?		–
	Could "Input/Bluetooth Vol." be lowered?		p. 36

Error Messages

Indication	Meaning
Error 2	An error occurred during writing. The USB flash drive may be corrupted.
	Insert other USB flash drive and try again. Alternatively, you can initialize the USB flash drive (p. 33).
	The internal memory might be damaged. Format the internal memory (p. 33).
Error 3	The same file already exists.
Error 10	No USB flash drive is inserted. Insert the USB flash drive and try again.
	The internal memory might be damaged. Format the internal memory (p. 33).
Error 11	There is not sufficient free memory in the save destination.
	Either insert other USB flash drive or delete unneeded files and try again.
Error 14	An error occurred during reading. The USB flash drive may be corrupted.
	Insert other USB flash drive and try again. Alternatively, you can initialize the USB flash drive (p. 33).
	The internal memory might be damaged. Format the internal memory (p. 33).
Error 15	The file is unreadable. The data format is not compatible with the unit.
Error 18	This audio format is not supported.
	Use an WAV format (44.1 kHz, 16-bit linear) or MP3 format audio file.
Error 30	Internal memory capacity of the unit is full.
Error 40	The unit cannot deal with the excessive MIDI data sent from the external MIDI device.
	Reduce the amount of MIDI data sent to the unit.
Error 43	A MIDI transmission error has occurred. Check the connected MIDI device.
Error 51	There may be a problem with the system. Repeat the procedure from the beginning. If it is not solved after you have tried several times, contact Roland Support.
Error 65	The USB Memory port was subjected to excessive current. Make sure that there is no problem with the USB flash drive, then turn the power off, then on again.

English

日本語

Deutsch

Français

Italiano

Español

Português

Nederlands

简体中文

Main Specifications

	RP701	F701
Sound generator	Piano Sound: SuperNATURAL Piano	
Keyboard	PHA-4 Standard Keyboard: with Escapement and Ivory Feel (88 keys)	
Bluetooth	Bluetooth Ver 4.2 Supported profiles: A2DP (Audio), GATT (MIDI over Bluetooth Low Energy) Supported codec: SBC (compatible with SCMS-T content protection)	
Power Supply	AC Adaptor	
Power consumption	20 W (When using the included AC adaptor)	20 W (When using the included AC adaptor)
	Approximate power consumption when playing the piano at medium volume: 4 W (RP701), 4 W (F701) Power consumption when sound has not been played after power-on: 3 W (RP701), 3 W (F701)	
Dimensions	With music rest: 1,366 (W) x 463 (D) x 1,027 (H) mm 53-13/16 (W) x 18-1/4 (D) x 40-7/16 (H) inches	With keyboard cover closed: 1,360 (W) x 345 (D) x 781 (H) mm 53-9/16 (W) x 13-5/8 (D) x 30-3/4 (H) inches With keyboard cover opened: 1,360 (W) x 345 (D) x 913 (H) mm 53-9/16 (W) x 13-5/8 (D) x 36 (H) inches * Measurements include stabilizer components attached.
Weight	46.0 kg/101 lbs 7 oz	36.0 kg/79 lbs 6 oz
Accessories	Owner's Manual, Leaflet "USING THE UNIT SAFELY," The collection of scores "Roland Piano Masterpieces" (CHINA only), AC adaptor, Power cord, Headphone hook, Stabilizer (F701)	
Option (sold separately)	Headphones	

* This document explains the specifications of the product at the time that the document was issued. For the latest information, refer to the Roland website.

Tone List

Piano

No.	Tone Name
Grand	
1	Concert Piano
2	Ballad Piano
3	Mellow Piano
4	Bright Piano
Upright	
5	Upright Piano
6	Mellow Upright
7	Bright Upright
8	Rock Piano
9	Ragtime Piano
Classical	
10	Fortepiano
11	Mellow Forte
12	Bright Forte
13	Harpsichord
14	Harpsi 8'+4'
E.Piano	
15	1976SuitCase
16	Tremolo EP
17	Pop EP
18	Vintage EP
19	FM E.Piano
20	EP Belle
21	60's EP
22	Clav.
23	Stage Phaser
24	70's EP
25	E.Grand
26	Magical Piano

Other

No.	Tone Name
Strings	
1	SymphonicStr1
2	Epic Strings
3	Rich Strings
4	Orchestra Str
5	Orchestra
6	Chamber Winds
7	Harp
8	Violin
9	Velo Strings
10	Cello
11	OrchestraBrs
12	Pizzicato Str
13	SymphonicStr2
14	Soft Pad
15	Flute
16	A.Bass+Cymb1
Organ	
17	Pipe Organ
18	Nason Flt 8'
19	Combo Jz.Org
20	Ballad Organ
21	ChurchOrgan1
22	ChurchOrgan2
23	Gospel Spin
24	Full Stops
25	Mellow Bars
26	Light Organ
27	Lower Organ
28	60's Organ
Voice	
29	Jazz Scat
Do Re Mi	
30	Do Re Mi 1#
31	Do Re Mi 1b
32	Do Re Mi 2#
33	Do Re Mi 2b
Drums	
34	STANDARD Set
35	ROOM Set
36	POWER Set
37	ELEC.Set
38	ANALOG Set
39	JAZZ Set
40	BRUSH Set
41	ORCH.Set
42	SFX Set
GM2	
43	Piano 1
44	Piano 1w
45	Piano 1d
46	Piano 2
47	Piano 2w
48	Piano 3
49	Piano 3w

No.	Tone Name
50	Honky-tonk
51	Honky-tonk w
52	E.Piano 1
53	Detuned EP 1
54	Vintage EP
55	60's E.Piano
56	E.Piano 2
57	Detuned EP 2
58	St.FM EP
59	EP Legend
60	EP Phaser
61	Harpsi.
62	Coupled Hps.
63	Harpsi.w
64	Harpsi.o
65	Clav.
66	Pulse Clav.
67	Celesta
68	Glockenspiel
69	Music Box
70	Vibraphone
71	Vibraphone w
72	Marimba
73	Marimba w
74	Xylophone
75	TubularBells
76	Church Bell
77	Carillon
78	Santur
79	Organ 1
80	TremoloOrgan
81	60's Organ
82	Organ 2
83	Perc.Organ 1
84	Chorus Organ
85	Perc.Organ 2
86	Rock Organ
87	Church Org.1
88	Church Org.2
89	Church Org.3
90	Reed Organ
91	Puff Organ
92	Accordion 1
93	Accordion 2
94	Harmonica
95	Bandoneon
96	Nylon-str.Gt
97	Ukulele
98	Nylon Gt o
99	Nylon Gt 2
100	Steel-str.Gt
101	12-str.Gt
102	Mandolin
103	Steel+Body
104	Jazz Guitar
105	Hawaiian Gt

No.	Tone Name
106	Clean Guitar
107	Chorus Gt 1
108	Mid Tone Gt
109	Muted Guitar
110	Funk Guitar1
111	Funk Guitar2
112	Chorus Gt 2
113	Overdrive Gt
114	Guitar Pinch
115	DistortionGt
116	Gt Feedback1
117	Dist.Rhy Gt
118	Gt Harmonics
119	Gt Feedback2
120	AcousticBass
121	FingeredBass
122	Finger Slap
123	Picked Bass
124	FretlessBass
125	Slap Bass 1
126	Slap Bass 2
127	Synth Bass 1
128	WarmSyn.Bass
129	Synth Bass 3
130	Clav.Bass
131	Hammer Bass
132	Synth Bass 2
133	Synth Bass 4
134	RubberSyn.Bs
135	Attack Pulse
136	Violin
137	Slow Violin
138	Viola
139	Cello
140	Contrabass
141	Tremolo Str.
142	PizzicatoStr
143	Harp
144	Yang Qin
145	Timpani
146	Strings
147	Orchestra
148	60's Strings
149	Slow Strings
150	Syn.Strings1
151	Syn.Strings3
152	Syn.Strings2
153	Choir 1
154	Choir 2
155	Voice
156	Humming
157	Synth Voice
158	Analog Voice
159	OrchestraHit
160	Bass Hit
161	6th Hit

English

日本語

Deutsch

Français

Italiano

Español

Português

Nederlands

简体中文

Tone List

No.	Tone Name
162	Euro Hit
163	Trumpet
164	Dark Trumpet
165	Trombone 1
166	Trombone 2
167	Bright Tb
168	Tuba
169	MuteTrumpet1
170	MuteTrumpet2
171	French Horn1
172	French Horn2
173	Brass 1
174	Brass 2
175	Synth Brass1
176	Synth Brass3
177	AnalogBrass1
178	Jump Brass
179	Synth Brass2
180	Synth Brass4
181	AnalogBrass2
182	Soprano Sax
183	Alto Sax
184	Tenor Sax
185	Baritone Sax
186	Oboe
187	English Horn
188	Bassoon
189	Clarinet
190	Piccolo
191	Flute
192	Recorder
193	Pan Flute
194	Bottle Blow
195	Shakuhachi
196	Whistle
197	Ocarina
198	Square Lead1
199	Square Lead2
200	Sine Lead
201	Saw Lead 1
202	Saw Lead 2
203	Doctor Solo
204	Natural Lead
205	SequencedSaw
206	Syn.Calliope
207	Chiffer Lead
208	Charang
209	Wire Lead
210	Solo Vox
211	5th Saw Lead
212	Bass+Lead
213	Delayed Lead
214	Fantasia
215	Warm Pad
216	Sine Pad
217	Polysynth

No.	Tone Name
218	Space Voice
219	Itopia
220	Bowed Glass
221	Metallic Pad
222	Halo Pad
223	Sweep Pad
224	Ice Rain
225	Soundtrack
226	Crystal
227	Synth Mallet
228	Atmosphere
229	Brightness
230	Goblins
231	Echo Drops
232	Echo Bell
233	Echo Pan
234	Star Theme
235	Sitar 1
236	Sitar 2
237	Banjo
238	Shamisen
239	Koto
240	Taisho Koto
241	Kalimba
242	Bagpipe
243	Fiddle
244	Shanai
245	Tinkle Bell
246	Agogo
247	Steel Drums
248	Woodblock
249	Castanets
250	Taiko
251	Concert BD
252	Melodic Tom1
253	Melodic Tom2
254	Synth Drum
255	TR-808 Tom
256	Elec.Perc.
257	Reverse Cym.
258	Gt FretNoise
259	Gt Cut Noise
260	BsStringSlap
261	Breath Noise
262	Fl.Key Click
263	Seashore
264	Rain
265	Thunder
266	Wind
267	Stream
268	Bubble
269	Bird 1
270	Dog
271	Horse Gallop
272	Bird 2
273	Telephone 1

No.	Tone Name
274	Telephone 2
275	DoorCreaking
276	Door
277	Scratch
278	Wind Chimes
279	Helicopter
280	Car Engine
281	Car Stop
282	Car Pass
283	Car Crash
284	Siren
285	Train
286	Jetplane
287	Starship
288	Burst Noise
289	Applause
290	Laughing
291	Screaming
292	Punch
293	Heart Beat
294	Footsteps
295	Gun Shot
296	Machine Gun
297	Laser Gun
298	Explosion

Internal Song List

No.	Song Name	Composer
Listening		
1	Valse, op.34-1	Fryderyk Franciszek Chopin
2	Polonaise op.53	Fryderyk Franciszek Chopin
3	Nocturne No.20	Fryderyk Franciszek Chopin
4	Die Forelle	Franz Peter Schubert, Arranged by Franz Liszt
5	Reflets dans l'Eau	Claude Achille Debussy
6	La Fille aux Cheveux de Lin	Claude Achille Debussy
7	La Campanella	Franz Liszt
8	Scherzo No.2	Fryderyk Franciszek Chopin
9	Barcarolle	Fryderyk Franciszek Chopin
10	Zhavoronok	Mikhail Ivanovich Glinka, Arranged by Mily Alexeyevich Balakirev
Ensemble		
1	Piano Concerto No.1 *	Peter Ilyich Tchaikovsky
2	Piano Concerto No.2 *	Sergei Rachmaninoff
3	Canon (Jazz Arrangement) *	Johann Pachelbel
4	Sicilienne (Jazz Arrangement) *	Gabriel Fauré
5	Berceuse from Dolly Suite	Gabriel Fauré
6	Le jardin féerique from Ma mère l'Oye	Maurice Ravel
7	Le Quattro Stagioni "La Primavera" *	Antonio Vivaldi
8	Marche Militaire Nr.1 *	Franz Peter Schubert
9	Waltz from the Sleeping Beauty *	Peter Ilyich Tchaikovsky
10	L'Apprenti sorcier *	Paul Dukas
11	Salut d'Amour	Edward Elgar
12	Pavane pour une infante défunte	Maurice Ravel
13	Menuett G Dur BWV Anh.114	Johann Sebastian Bach
14	Präludium C Dur BWV846	Johann Sebastian Bach
15	Türkischer Marsch	Wolfgang Amadeus Mozart
16	Für Elise	Ludwig van Beethoven
17	Türkischer Marsch	Ludwig van Beethoven
18	Auf Flügeln des Gesanges	Felix Mendelssohn
19	Étude, op.10-3	Fryderyk Franciszek Chopin
20	Valse, op.64-1	Fryderyk Franciszek Chopin
21	Fantaisie-Impromptu	Fryderyk Franciszek Chopin
22	Träumerei	Robert Alexander Schumann
23	Dolly's Dreaming Awakening	Theodor Oesten
24	Brautchor	Wilhelm Richard Wagner
25	Liebesträume Nr.3	Franz Liszt
26	Ungarische Tänze Nr.5	Johannes Brahms
27	Clair de Lune	Claude Achille Debussy
28	1ère Arabesque	Claude Achille Debussy
29	Golliwog's Cakewalk	Claude Achille Debussy
30	Je te veux	Erik Satie

No.	Song Name	Composer
Entertainment		
1	Polovtsian Dances	Alexander Borodin
2	Ombra mai fù	George Frideric Handel
3	Lascia ch'io pianga	George Frideric Handel
4	Twinkle Twinkle Little Star	French Folk Song
5	Mary Had a Little Lamb	Traditional
6	Bear Song	American Folk Song
7	Ich Bin Ein Musikante	German Folk Song
8	Grand Father's Clock	Henry Work
9	Jingle Bells	James Pierpont
10	We Wish You a Merry Christmas	Carol
11	Silent Night	Franz Gruber
12	Amazing Grace	Hymn
13	Lavender's Blue	Traditional
14	Aura Lee	George R. Poulton
15	Auld Lang Syne	Traditional
16	Greensleeves	Traditional
17	Maple Leaf Rag	Scott Joplin
18	The Entertainer	Scott Joplin
19	When The Saints Go Marching In	Traditional
20	Little Brown Jug	Joseph Winner

English

日本語

Deutsch

Français

Italiano

Español

Português

Nederlands

简体中文

Internal Song List

No.	Song Name	Composer
DoReMi		
1-15	Training No.1 - 15	Roland Corporation
16	Twinkle Twinkle Little Star	French Folk Song
17	Summ,Summ,Summ	Traditional
18	Frog Song	German Folk Song
19	The Cuckoo	Traditional
20	Oh! Susanna	Stephen Foster
21	Let's Clap Hands	Traditional
22	Das klinget so herrlich	Wolfgang Amadeus Mozart
23	Wiegenlied	Johannes Brahms
24	Les Patineurs	Émile Waldteufel
25	Minuet	Johann Sebastian Bach
26	Old Folks At Home	Stephen Foster
27	Deck the Halls	Carol
28	Danny Boy	Irish Song
29	Korobeiniki	Russian Folk Song
30	Sakura Sakura	Japanese Folk Song
Scales		
1-36	Major Scales, Minor Scales	-
Hanon		
1-20	1-20	Charles-Louis Hanon
Beyer		
1-106	1-106	Ferdinand Beyer

No.	Song Name	Composer
Burgmuller		
1	Openness	Johann Friedrich Franz Burgmüller
2	Arabesque	
3	Pastoral	
4	A Small Gathering	
5	Innocence	
6	Progress	
7	The Clear Stream	
8	Gracefulness	
9	The Hunt	
10	Tender Flower	
11	The Young Shepherdess	
12	Farewell	
13	Consolation	
14	Austrian Dance	
15	Ballad	
16	Sighing	
17	The Chatterbox	
18	Restlessness	
19	Ave Maria	
20	Tarantella	
21	Angelic Harmony	
22	Gondola Song	
23	The Return	
24	The Swallow	
25	The Knight Errant	
Czerny 100		
1-100	1-100	Carl Czerny

- All rights reserved. Unauthorized use of this material for purposes other than private, personal enjoyment is a violation of applicable laws.
- Songs marked by an asterisk (*) are arranged by Roland Corporation. The copyrights to these songs are owned by the Roland Corporation.
- Songs in Listening category are piano solos. They have no accompaniment.
- Please purchase commercially available scores for Hanon-Czerny no. 100.
- The performance data for the tone demos and the internal songs is not transmitted from the USB Computer port or via Bluetooth (MIDI).
- If the SMF Play Mode is set to "Internal, (p. 36)" there will be some parts whose volume does not change when you adjust the Song Volume SMF value (p. 35). If the SMF Play Mode is set to "External," the volume of all parts will change.

USING THE UNIT SAFELY

INSTRUCTIONS FOR THE PREVENTION OF FIRE, ELECTRIC SHOCK, OR INJURY TO PERSONS

About ⚠ WARNING and ⚠ CAUTION Notices

⚠ WARNING	Used for instructions intended to alert the user to the risk of death or severe injury should the unit be used improperly.
⚠ CAUTION	Used for instructions intended to alert the user to the risk of injury or material damage should the unit be used improperly. * Material damage refers to damage or other adverse effects caused with respect to the home and all its furnishings, as well to domestic animals or pets.

About the Symbols

	The ⚠ symbol alerts the user to important instructions or warnings. The specific meaning of the symbol is determined by the design contained within the triangle. In the case of the symbol at left, it is used for general cautions, warnings, or alerts to danger.
	The ⓧ symbol alerts the user to items that must never be carried out (are forbidden). The specific thing that must not be done is indicated by the design contained within the circle. In the case of the symbol at left, it means that the unit must never be disassembled.
	The ● symbol alerts the user to things that must be carried out. The specific thing that must be done is indicated by the design contained within the circle. In the case of the symbol at left, it means that the power-cord plug must be unplugged from the outlet.

ALWAYS OBSERVE THE FOLLOWING

⚠ WARNING

Concerning the Auto Off function

The power to this unit will be turned off automatically after a predetermined amount of time has passed since it was last used for playing music, or its buttons or controls were operated (Auto Off function). If you do not want the power to be turned off automatically, disengage the Auto Off function (p. 38).



Use only the supplied AC adaptor and the correct voltage

Be sure to use only the AC adaptor supplied with the unit. Also, make sure the line voltage at the installation matches the input voltage specified on the AC adaptor's body. Other AC adaptors may use a different polarity, or be designed for a different voltage, so their use could result in damage, malfunction, or electric shock.



Use only the supplied power cord

Use only the attached power cord. Also, the supplied power cord must not be used with any other device.



⚠ CAUTION

Cautions when moving this unit

If you need to move the instrument, take note of the precautions listed below. At least two persons are required to safely lift and move the unit. It should be handled carefully, all the while keeping it level. Make sure to have a firm grip, to protect yourself from injury and the instrument from damage.



- Check to make sure the Screws securing the unit to the stand have not become loose. Fasten them again securely whenever you notice any loosening.
- Disconnect the power cord.
- Disconnect all cords coming from external devices.
- Raise the adjusters on the stand (RP701) (p. 7).
- Close the keyboard cover.
- Remove the music stand (RP701).

Take care so as not to get fingers pinched

When handling the following moving parts, take care so as not to get fingers, toes, etc., pinched. Whenever a child uses the unit, an adult should be on hand to provide supervision and guidance.



- Keyboard Cover (p. 6)(p. 10)
- Pedals (p. 7)(p. 11)

⚠ CAUTION

Precautions concerning use of bench

When using the bench, please observe the following points:

- Do not use the bench as a toy, or as a stepping stool.
- Do not allow two or more persons to sit on the bench.
- Do not adjust the height while sitting on the bench.
- Do not sit on the bench if the bolts holding the bench legs are loose. (If the bolts are loose, immediately re-tighten them using the supplied tool.)
- Never insert your hand into the gap (the metal height adjustment mechanism) under the seat keyboard cover. Doing so may cause your hand to be pinched or injured.



Keep small items out of the reach of children

To prevent accidental ingestion of the parts listed below, always keep them out of the reach of small children.

- Included Parts
- Screws





IMPORTANT NOTES

Power Supply

- Place the AC adaptor so the side with the indicator faces upwards. The indicator will light when you plug the AC adaptor into an AC outlet.

Placement

- Do not allow lighting devices that normally are used while their light source is very close to the unit (such as a piano light), or powerful spotlights to shine upon the same area of the unit for extended periods of time. Excessive heat can deform or discolor the unit.
- Do not allow objects to remain on top of the keyboard. This can be the cause of malfunction, such as keys ceasing to produce sound.
- Depending on the material and temperature of the surface on which you place the unit, its rubber feet may discolor or mar the surface (F701).

Maintenance

- To clean the unit, use a dry, soft cloth; or one that is slightly dampened. Try to wipe the entire surface using an equal amount of strength, moving the cloth along with the grain of the wood. Rubbing too hard in the same area can damage the finish.
- The Pedals of this unit are made of brass. Brass eventually darkens as the result of the natural oxidization process. If the brass becomes tarnished, polish it using commercially available metal polisher (RP701).

Care of the Keyboard

- Do not write on the keyboard with any pen or other implement, and do not stamp or place any marking on the instrument. Ink will seep into the surface lines and become unremovable.
- Do not affix stickers on the keyboard. You may be unable to remove stickers that use strong adhesives, and the adhesive may cause discoloration.
- To remove stubborn dirt, use a commercially available keyboard cleaner that does not contain abrasives. Start by wiping lightly. If the dirt does not come off, wipe using gradually increasing amounts of pressure while taking care not to scratch the keys.

Repairs and Data

- Before sending the unit away for repairs, be sure to make a backup of the data stored within it; or you may prefer to write down the needed information. Although we will do our utmost to preserve the data stored in your unit when we carry out repairs, in some cases, such as when the memory section is physically damaged, restoration of the stored content may be impossible. Roland assumes no liability concerning the restoration of any stored content that has been lost.

Additional Precautions

- Any data stored within the unit can be lost as the result of equipment failure, incorrect operation, etc. To protect yourself against the irretrievable loss of data, try to make a habit of creating regular backups of the data you've stored in the unit.
- Roland assumes no liability concerning the restoration of any stored content that has been lost.
- Never strike or apply strong pressure to the display.
- The sound of keys being struck and vibrations produced by playing an instrument can be transmitted through a floor or wall to an unexpected extent. Please take care not to cause annoyance to others nearby.
- When disposing of the packing carton or cushioning material in which this unit was packed, you must observe the waste disposal regulations that apply to your locality.
- Do not apply undue force to the music stand while it is in use (RP701).
- Do not use connection cables that contain a built-in resistor.

Using External Memories

- Please observe the following precautions when handling external memory devices. Also, make sure to carefully observe all the precautions that were supplied with the external memory device.
 - Do not remove the device while reading/writing is in progress.
 - To prevent damage from static electricity, discharge all static electricity from your person before handling the device.

Caution Regarding Radio Frequency Emissions

- The following actions may subject you to penalty of law.
 - Disassembling or modifying this device.
 - Removing the certification label affixed to the back of this device.
 - Using this device in a country other than where it was purchased

Intellectual Property Right

- It is forbidden by law to make an audio recording, video recording, copy or revision of a third party's copyrighted work (musical work, video work, broadcast, live performance, or other work), whether in whole or in part, and distribute, sell, lease, perform or broadcast it without the permission of the copyright owner.
- Do not use this product for purposes that could infringe on a copyright held by a third party. We assume no responsibility whatsoever with regard to any infringements of third-party copyrights arising through your use of this product.
- The copyright of content in this product (the sound waveform data, style data, accompaniment patterns, phrase data, audio loops and image data) is reserved by Roland Corporation.
- Purchasers of this product are permitted to utilize said content (except song data such as Demo Songs) for the creating, performing, recording and distributing original musical works.
- Purchasers of this product are NOT permitted to extract said content in original or modified form, for the purpose of distributing recorded medium of said content or making them available on a computer network.
- This product contains eParts integrated software platform of eSOL Co.,Ltd. eParts is a trademark of eSOL Co., Ltd. in Japan.
- The Bluetooth® word mark and logos are registered trademarks owned by Bluetooth SIG, Inc. and any use of such marks by Roland is under license.
- This Product uses the Source Code of µT-Kernel under T-License 2.0 granted by the T-Engine Forum (www.tron.org).
- This product includes third party open source software.
 - Copyright © 2009-2018 Arm Limited. All rights reserved.
 - Copyright © 2018 STMicroelectronics. All rights reserved.
 - Licensed under the Apache License, Version 2.0 (the "License"); You may obtain a copy of the License at <http://www.apache.org/licenses/LICENSE-2.0>
 - Copyright © 2018 STMicroelectronics. All rights reserved.
 - This software component is licensed by ST under BSD 3-Clause license, the "License"; You may obtain a copy of the License at <https://opensource.org/licenses/BSD-3-Clause>
 - This product is using the Jansson (<http://www.digip.org/jansson/>) source code.
 - Copyright © 2009-2016 Petri Lehtinen <petri@digip.org> Released under the MIT license <http://opensource.org/licenses/mit-license.php>
- The "Chinese language font MORISAWA SONG GB2312BMP12" used by this product is provided by Morisawa Corporation, and copyright to the font data is the property of that corporation.
- Roland and SuperNATURAL are either registered trademarks or trademarks of Roland Corporation in the United States and/or other countries.
- Company names and product names appearing in this document are registered trademarks or trademarks of their respective owners.

Index

A	
Ambience	22
Auto Memory Backup	38
Auto Off	6, 10, 38
B	
[↵] (back) button	5, 7, 9, 11
[◀ (🎵)] (beginning of song)	5, 9
Bluetooth	15, 29
[📶 (🎵)] (Bluetooth)	5, 9
Bluetooth On/Off	34
Brilliance	22
C	
Classic Position	6
D	
Damper pedal	7, 11
Damper Resonance	28
DC In jack	4, 8, 20
Display	5, 9
Display Contrast	37
Dual Play	21, 35
[🎹 + 🎹] (Dual Play)	5, 9
F	
Factory Reset	33, 38
Format Media	33, 38
Function Mode	34
H	
Hammer Response	27
Headphone hook	4, 8
Headphone jack	4, 8, 20
Headphones	7, 11
Headphones 3D Ambience	7, 11, 22
I	
Input/Bluetooth Vol.	36
Input jack	4, 8, 20
Internal Song	13, 45
K	
Kbd Transpose	35
Key Off Resonance	28
key touch	22
L	
Lid	28
Local Control	37
M	
Master Tuning	27
[x/y](measure) button	5, 9
Metronome	14, 22
[🎵] (metronome) button	5, 9, 14
[⚙️🎵] (metronome settings)	5, 9, 22
MIDI Transmit Ch.	37
Music rest	5, 7

O	
[🎹] (other) button	5, 9, 12
overdubrecord	26
P	
Pairing	15, 29
Panel Lock	33
part	13, 25
[🎹🎹] (part) button	5, 9, 13, 25
Pedal	5, 7, 9, 11
Pedal jack	4, 8, 20
[🎹] (Piano) button	5, 9
Piano Designer	27
Piano Setup Export	32, 38
Piano Setup Import	32, 38
Playing Back a Song	13, 23
[▶/■] (play/stop) button	5, 9
[🔌] (Power) button	5, 6, 9, 10
R	
Recording	14, 24
[●] (recording) button	5, 9
S	
Screen Saver	37
[⏵] (select/confirm) knob	5, 7, 9, 11
[⚙️] (settings) button	5, 9, 34
Single Note Character	28
Single Note Tuning	28
Single Note Volume	28
SMF Play Mode	36
Soft pedal	7, 11
[🎵] (song) button	5, 9
Sostenuto pedal	7, 11
Speaker Auto Mute	37
Split Play	21, 35
Split point	21
stop	5, 9
String Resonance	28
T	
Temperament	27
Temperament Key	27
tempo	13, 14, 22
[♩=] (Tempo) button	5, 9, 13, 22
Tone	12, 43
Twin Piano	35
U	
USB Audio Input Volume	36
USB Computer port	4, 8, 20
USB Memory port	4, 8, 20

V	
[🔊] (Volume-) button	5, 9
[🔊+] (Volume+) button	5, 9
Volume buttons	6, 10
Volume indicator	5, 9
Volume Limit	37

English

日本語

Deutsch

Français

Italiano

Español

Português

Nederlands

简体中文

 **Roland**