

## Look What You Can Do with the FP-30X

### Play the Piano

**Play various sounds** ▶ page 2

This unit contains a wide variety of tones (sounds). You can freely select and perform using these tones.

**Play two layered tones (Dual Play)** ▶ page 2

You can layer two tones on a single key.

**Play different tones with your left and right hands (Split Play)** ▶ page 2

You can divide the keyboard into left and right zones, and select a different tone for each zone.

### Convenient Functions

**Record your performances** ▶ page 3

You can record your own keyboard performance, and then play back to check it.

**Bluetooth function** ▶ page 6

You can use the **Bluetooth**-compatible app "Roland Piano App" or play back audio from your smartphone.

### Contents

<b>Easy Operation Guide (Front Panel)</b> .....	<b>2</b>	<b>Advanced Operation</b> .....	<b>9</b>
Selecting a Tone .....	2	Adjusting the Brilliance (Brilliance) .....	9
Adjusting the Volume .....	2	Adjusting the Reverberation (Ambience) .....	9
Making Settings for Each Function (Function) .....	2	Dividing the Keyboard for Two People (Twin Piano).....	9
Playing Different Tones with Left and Right Hands (Split Play).....	2	Convenient Metronome Functions .....	9
Using the Metronome.....	3	Changing the Pitch of the Tone in Octave Steps (Octave Shift) .....	10
Recording Your Performance .....	3	Sounding a Count Before Playback/Recording (Count-In).....	10
Playing Back Internal Songs .....	3	Outputting Sound Both from Headphones and Internal Speakers (Speaker Auto Mute) .....	11
<b>Before You Play</b> .....	<b>4</b>	Formatting a USB Flash Drive .....	11
Placing the FP-30X on a Stand .....	4	Saving the Settings (Memory Backup).....	11
Connecting Equipment (Phones Jacks) .....	4	Restoring the Factory Settings (Factory Reset) .....	11
Attaching the Music Rest .....	4	Various Function Settings (Function Mode) .....	12
Connecting Equipment (Rear Panel) .....	5	<b>Troubleshooting</b> .....	<b>13</b>
Turning On/Off the Power .....	5	<b>Internal Song List</b> .....	<b>13</b>
Making the Power Automatically Turn Off After a Time (Auto Off) .....	5	<b>USING THE UNIT SAFELY</b> .....	<b>14</b>
<b>Connecting the Piano and a Mobile Device via Bluetooth</b> ...	<b>6</b>	<b>IMPORTANT NOTES</b> .....	<b>14</b>
Here's What You Can Do .....	6	<b>Main Specifications</b> .....	<b>15</b>
Playing Music Through the Piano's Speakers (Bluetooth Audio) .....	6	<b>List of Operations (Button and Key Combinations)</b> .....	<b>16</b>
Using the Piano with an App (Bluetooth MIDI).....	7		

## Download the apps

Download these smartphone/tablet apps and use them with your piano.

iOS/iPadOS  
Android



This app lets you view sheet music in digital form, practice songs as if you were playing a game, or keep a record of your practicing.



This app lets you customize the piano sound to your taste.

Before using this unit, carefully read "USING THE UNIT SAFELY" and "IMPORTANT NOTES" (leaflet "USING THE UNIT SAFELY" and Owner's Manual (page 14)). After reading, keep the document(s) including those sections where it will be available for immediate reference.



## Using the Metronome

Turn the [Metronome] button on; the metronome will sound. Use the [SLOW] / [FAST] buttons to adjust the tempo.

### Changing the Number of Beats

Holding down the [Metronome] button and press the [SLOW] / [FAST] buttons.

You can choose from 0 (weak beats only), 2 (2 beats), 3 (3 beats), 4 (4 beats), 5 (5 beats), 6 (6 beats), or 7 (7 beats).

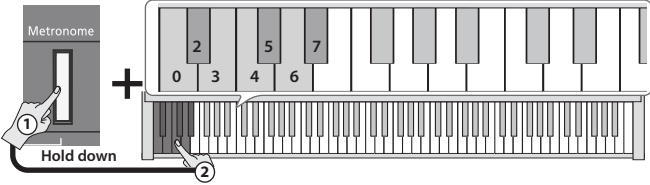

\* Choose "0" if you want the strong beat to be omitted and only the weak beats sounded.

### Specifying a Numeric Tempo

A numeric value can also be specified for the tempo (10–500) (default: 108).

**Example:** To enter 120, hold down the [Metronome] button and press the keys in this order: 1 → 2 → 0 → Enter.

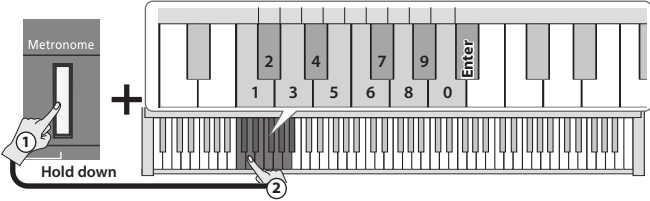

## Playing Back Internal Songs

To play or stop a song, press the [▶/■] button.

You can select an internal song by holding down the [▶/■] button and pressing one of the following keys.

For details on the song names, refer to "Internal Song List" (p. 13).

### Selecting an Internal Song

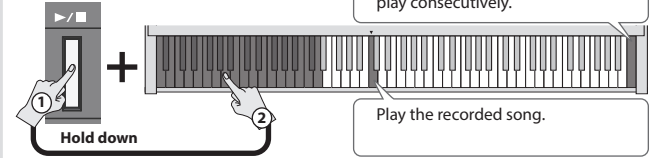

Press the right end key; all songs play consecutively.

Play the recorded song.

### Song Volume

Here's how to adjust the song volume (SMF/audio). (10 steps, default value = 10).

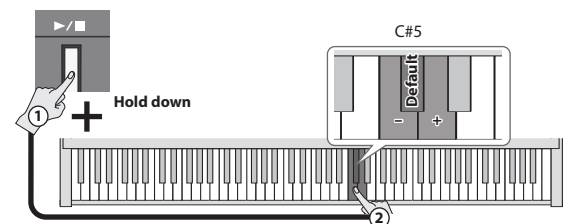

\* You can't adjust the mix balance of the demo songs.

\* If the SMF playback mode (p. 12) is set to "Auto-Select" or "Internal," the volume of some parts is not changed by the song volume. If this is set to "External," the song volume changes the volume of all parts.

### Listening to the Demo Songs

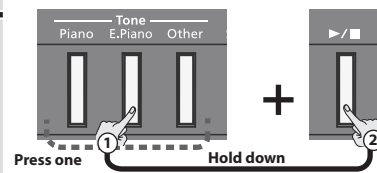

You can play back demo songs that use the sounds of each Tone button (a total of three songs).

Press the [▶/■] button to stop.

- \* Use of these demo songs for any purpose other than personal enjoyment is prohibited by law unless permission is obtained from the copyright owner.
- \* No data for the demo songs will be output from USB Computer port.

## Recording Your Performance

Here's how to record a song.

\* Before you begin, select the sound that you want to record.

**1. Press the [●] button.**

\* To cancel recording, press the [●] button once again.

**2. Play the keyboard to start recording.**

**3. Press the [▶/■] button to stop recording.**

### If You Want to Record Along with the Metronome

\* Before recording, sound the metronome and set the number of beats and tempo. If you press the [▶/■] button in step 2, recording starts after a one-measure count.

### Playing the Song You Recorded

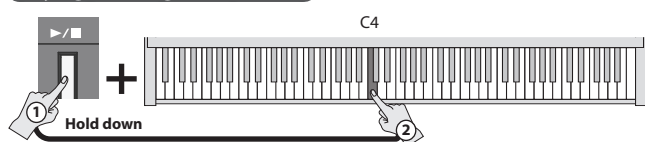

### If You Want to Redo the Recording

Start recording again from step 1.

### Saving the Recorded Song to a USB Flash Drive

\* Connect your USB flash drive before you continue.

Hold down the [Function] button and press the [▶/■] button.

Once all the buttons are lit, the data has been saved (up to 100 songs).

### Playing a Song from a USB Flash Drive

Hold down the [▶/■] button and press the "C#7" key.

You can use the two keys adjacent to "C#7" to select a song on the USB flash drive.

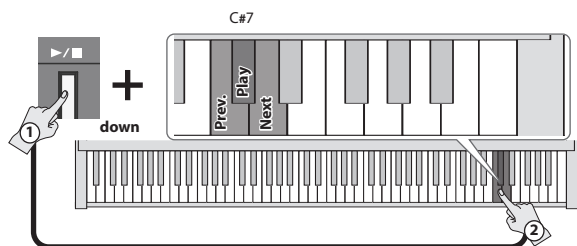

\* You can also copy a WAV file or MIDI file from your computer to a USB flash drive, and play it back on the FP-30X. For details on the formats that can be played, refer to "Formats Playable from a USB Flash Drive" (p. 15).

# Before You Play

## Placing the FP-30X on a Stand

If you want to place the FP-30X on a stand, use the Roland KSC-70 (refer to the KSC-70 Owner's Manual), KS-12, KS-20X or KS-10Z.

\* Be careful not to pinch your fingers when setting up the stand.

### KS-12

Adjust the height of the stand to the lowest position.

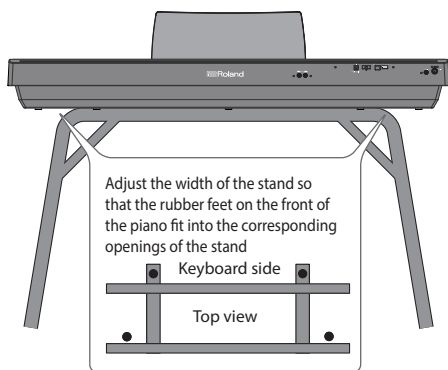

### KS-20X

Align the center of the Piano with the center of the stand.

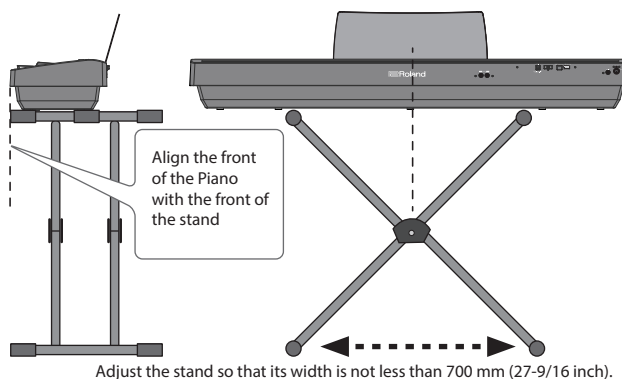

### KS-10Z

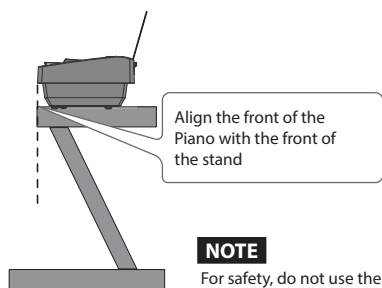

#### NOTE

For safety, do not use the stand in its very highest adjustment position.

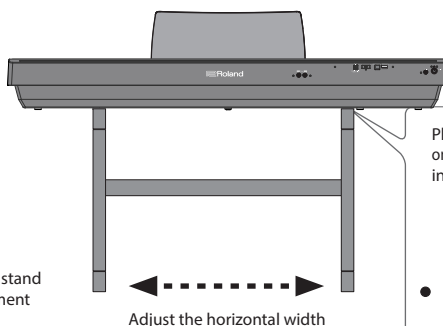

## Connecting Equipment (Phones Jacks)

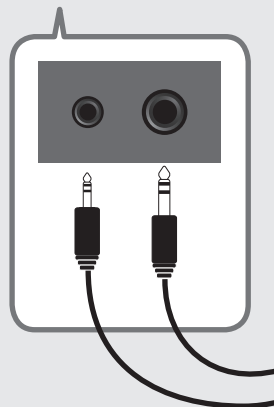

### Phones 1/2 jacks

You can connect stereo headphones here. Since the FP-30X has two headphone jacks, two people can use headphones at the same time.

\* The headphone jack on the left accommodates a stereo mini-plug, and the jack on the right accommodates a stereo 1/4" plug. Use the jack that fits the plug of your headphones.



Headphones

## Attaching the Music Rest

1. Insert the music rest into the slit on the top of the piano.

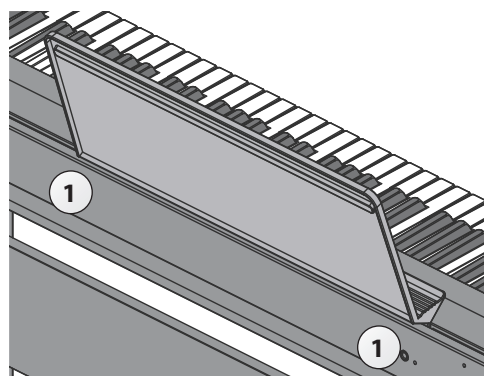

## Connecting Equipment (Rear Panel)

\* To prevent malfunction and equipment failure, always turn down the volume, and turn off all the units before making any connections.

### DC In jack

Connect the included AC adaptor.

Place the AC adaptor so the side with the indicator (see illustration) faces upwards.  
The indicator will light when you plug the AC adaptor into an AC outlet.

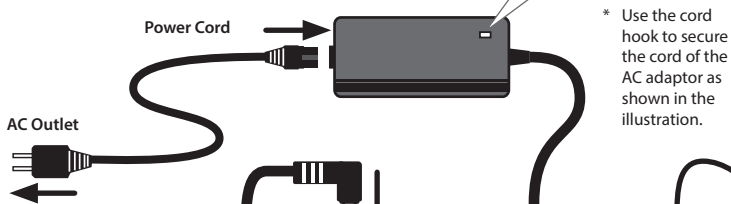

\* Use the cord hook to secure the cord of the AC adaptor as shown in the illustration.

### USB Memory port

Connect a USB flash drive (sold separately).

If a USB flash drive is connected, you can play or save songs.

- \* Never turn off the power or disconnect a USB flash drive or the power cord while the access indicator of the USB flash drive is blinking.
- \* Taking care to observe the correct direction and orientation, insert the USB flash drive all the way into the port. Do not use excessive force.

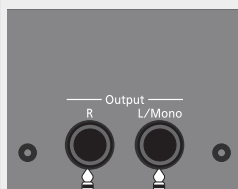

### Amplified speakers

You can connect amplified speakers and hear the sound of the piano through them.

- \* If the sound is distorted when external speakers are connected, slightly lower the volume of the FP-30X.

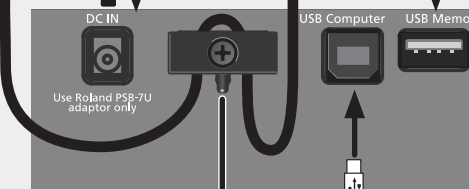

### USB Computer port

Here you can connect your computer via a USB cable (sold separately). If your computer is connected, performance data and audio signals can be transferred between the piano and sequencer software (sold separately) on your computer, allowing you to produce or edit music.

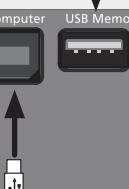

### Pedal 1 jack

Connect the included damper pedal.

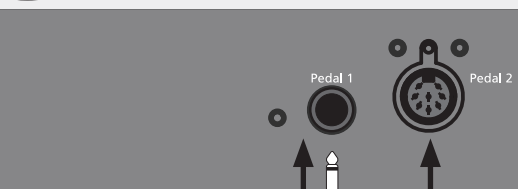

### Pedal 2 jack

If connecting the dedicated pedal (KPD-70; sold separately) to the dedicated stand (KSC-70; sold separately), connect the KPD-70's cable here.

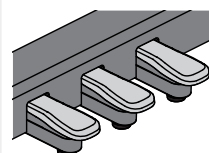

#### Damper Pedal

Use this pedal to sustain the sound.

#### Sostenuto Pedal

The notes you are pressing when this pedal is depressed will be sustained.

#### Soft Pedal

This pedal is used to make the sound softer.

\* When operating the pedal, take care not to pinch your fingers between the moving part and the body of the unit. Pay special attention to this when using the unit where children are present.

## Turning On/Off the Power

Once everything is properly connected, be sure to follow the procedure below to turn on their power. If you turn on equipment in the wrong order, you risk causing malfunction or equipment failure.

### Turning the power on

#### 1. Long-press the [⏻] (Power) button to turn the power on.

- \* This unit is equipped with a protection circuit. A brief interval (a few seconds) after turning the unit on is required before it will operate normally.
- \* Before turning the unit on/off, always be sure to turn the volume down. Even with the volume turned down, you might hear some sound when switching the unit on/off. However, this is normal and does not indicate a malfunction.

### Turning the power off

#### 1. Hold down the [⏻] (Power) button for one second or longer; the power will be turned off.

- \* Do not disconnect the power cord while the [⏻](power) button is blinking.

## Making the Power Automatically Turn Off After a Time (Auto Off)

The power to this unit will be turned off automatically after a predetermined amount of time has passed since it was last used for playing music, or its buttons or controls were operated (Auto Off function).

If you do not want the power to be turned off automatically, disengage the Auto Off function. (Default: 240 min.)

- \* Auto-off settings are automatically saved in this unit.

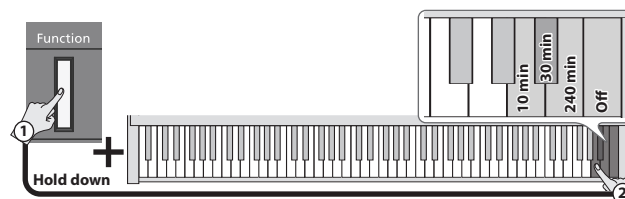

- Any settings that you are in the process of editing will be lost when the power is turned off. If you have any settings that you want to keep, you should save them beforehand.
- To restore power, turn the power on again.

# Connecting the Piano and a Mobile Device via **Bluetooth**



## Here's What You Can Do

By using the **Bluetooth** function, you can wirelessly connect the piano with a mobile device such as your smartphone or tablet (subsequently referred to as the "mobile device"), allowing you to do the following things.

### → "Playing Music Through the Piano's Speakers (Bluetooth Audio)"

p. 6

A song played back on your mobile device can be heard wirelessly through the piano's speakers. You can also play the piano along with the song that's being played back.

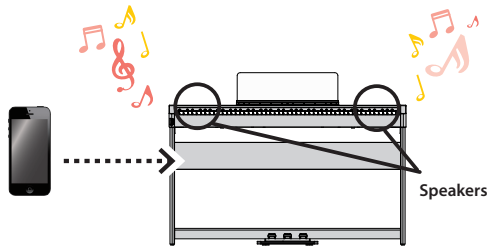

### → "Using the Piano with an App (Bluetooth MIDI)"

p. 7

You can install apps (such as Roland's "Roland Piano App" and "Piano Designer") on your mobile device and use them together with the piano.

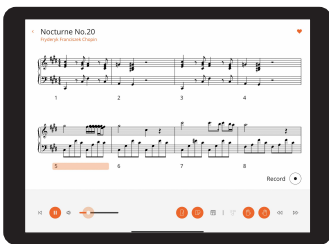

Roland Piano App



Piano Designer

## Playing Music Through the Piano's Speakers (Bluetooth Audio)

A song played back on your mobile device can be heard wirelessly through the piano's speakers.

- \* If your mobile device is already paired with the piano, there is no need to perform pairing again. Refer to "Connecting an Already-Paired Mobile Device" (p. 7).

## Making Initial Settings (Pairing)

As an example, we explain how to make settings for an iPad. If you're using an Android device, refer to the owner's manual of the mobile device you're using.

1. Place the mobile device that you want to connect nearby this unit.
2. Hold down the [Function] button for at least five seconds.

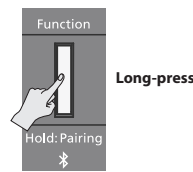

Pairing begins.

3. Turn on the **Bluetooth** function of the mobile device.

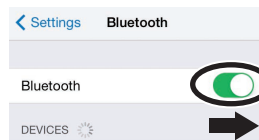

4. Tap "FP-30X Audio" that is shown in the **Bluetooth** device screen of your mobile device.

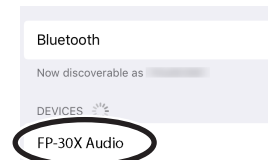

The piano and mobile device are paired. When pairing is completed, a display like the following appears.

Mobile device	"FP-30X Audio" is added in the "My Devices" field
Piano	[Function] button is lit (blue)

This completes initial settings.

## Pairing

To wirelessly connect the piano with your mobile device, you must first perform "pairing" to create a one-to-one connection between the piano and your mobile device.

"Pairing" is the procedure of registering (mutually authenticating) your mobile device with the piano.

Pair your device as described in the procedure for each function.

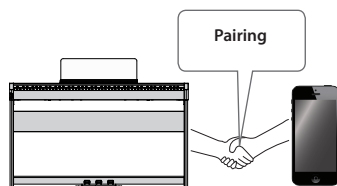

## The pairing process

Separate pairing is required for "playing music through the piano's speakers" and for "using the piano with an app." Note that these processes are different.

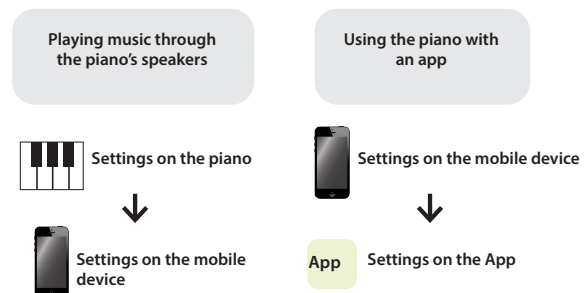

\* If pairing is not successful, refer to "If Pairing Does Not Succeed" (p. 8).

## Connecting an Already-Paired Mobile Device

1. Turn on the **Bluetooth** function of the mobile device.  
The piano and the mobile device are wirelessly connected.

### MEMO

If you were unable to establish a connection using the procedure above, tap "FP-30X Audio" that is displayed in the **Bluetooth** device screen of the mobile device.

## Playing Back Audio

When you play back music data on the mobile device, the sound is heard from the piano's speakers.

## Adjusting the volume of Bluetooth audio

Normally you'll adjust the volume on your mobile device. If this does not provide the volume adjustment you want, you can adjust the volume as follows.





1. While holding down the [Function] button, press the keyboard's C1, C#1, or D1 keys to adjust the volume.

Key to press	Explanation
C1	Change the volume by -1.
C#1	Set the volume to the default value (7).
D1	Change the volume by +1.
Range of setting	1-10 (default: 7)

## Using the Piano with an App (Bluetooth MIDI)

Here's how to make settings so that you can use the piano with an app that's installed on your mobile device.

## Apps You Can Use with This Piano

App name	Supported OS	Explanation
 Roland Piano App	iOS iPadOS Android	This app lets you view sheet music in digital form, practice songs as if you were playing a game, or keep a record of your practicing. 
 Piano Designer	iOS Android	This app lets you customize the piano sound to your taste. It provides touch-based editing within the app for the various elements of the sound. 

- \* Apps can be downloaded from the App Store or Google Play (free of charge).
- \* In addition to the above, you can also use music apps (such as Garage Band) that are compatible with **Bluetooth** MIDI.
- \* The information provided about apps made by Roland was current when this manual was published. For the latest information, refer to the Roland website.

## Making Settings (Pairing)

You can make settings for using the piano together with an app that's installed on your mobile device. As an example, we'll explain the procedure for using an iPad with the "Roland Piano App" app.

- \* In the case of "Using the Piano with an App," settings on the piano are not necessary. Perform operations in the app to pair it with the piano.

1. Turn on the **Bluetooth** function of the mobile device.

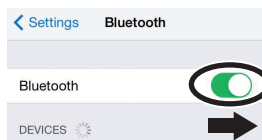

### NOTE

Even if the "Devices" field shows the name of the device you're using (such as "FP-30X MIDI"), do not tap it.

2. Start the app that you installed on your mobile device.
3. Tap "Connect piano".
4. Tap "FP-30X MIDI" (the name of the device you're using).

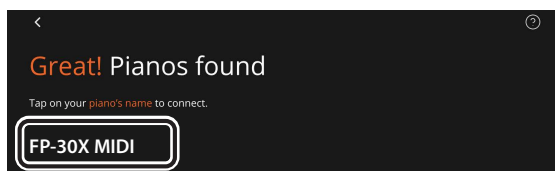

When "Bluetooth Pairing Request" is shown, tap "Pair".

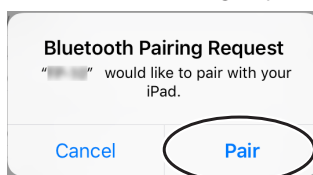

The piano and mobile device are paired. When pairing is completed, a display like the following appears.

Mobile device	"Connected with FP-30X MIDI" appears in the "Connection" area at the top of the app screen.
Piano	[Function] button is lit (blue)

Settings are now complete.

### MEMO

When connecting to a mobile device for which you've initialized the settings, the device automatically connects when you launch the app. The connection may take several seconds.

- \* If the piano doesn't connect with your mobile device, tap "Connection" at the top of the app screen, and then tap "Connect to Piano".

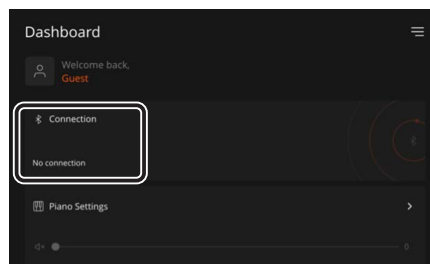

## If Pairing Does Not Succeed

If pairing is not successful in "Using the Piano with an App" (p. 7), try steps 1–4 below.

### 1 Make sure that the piano's Bluetooth function is "On."

1. While holding down the [Function] button, press the keyboard's A0 key.  
The piano's Bluetooth function turns on.

### 2 Exit all apps on your mobile device.

#### Closing the app

1. Double-click the home button, and swipe up on the app screen.

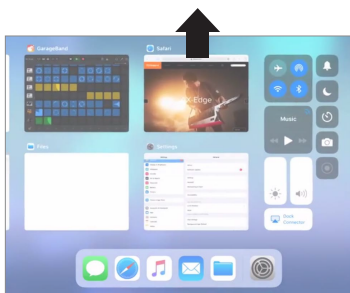

\* The way to exit an app may differ depending on your mobile device. Exit the apps using the method that's appropriate for your mobile device.

### 3 If already paired, cancel pairing, and turn off the Bluetooth function.

#### Cancelling the pairing

1. In the mobile device's screen, tap the "i" located beside "Connected," and tap "Forget This Device."

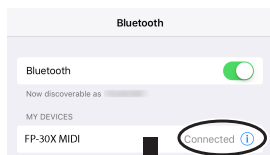

2. Turn the Bluetooth switch off.

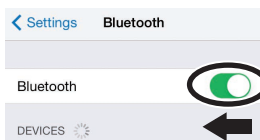

### 4 Perform the pairing procedure of p. 7 from step 1.

#### MEMO

If checking these points does not solve the problem, please refer to the Roland support website.

<https://www.roland.com/support/>

## To pair your device with multiple pianos

For example, if you want to pair your mobile device with multiple pianos located in a music school, you can specify an **Bluetooth ID** for each piano to pair your mobile device with the desired pianos.

\* When you make this setting, an ID number is added to the end of the device name shown on the mobile device (e.g., FP-30X Audio1).

1. Power-off the piano.
2. While holding down the [Volume] (left) button, long-press the [P] button.

When all Volume indicators blink, release your fingers.

The number of times that the Volume indicators blink shows the currently specified **Bluetooth ID**.

Value	Volume indicator
0	Lit ●●●●●
1	Lit ●●●●●      Blink 1 time ○○●●● Return to beginning
:	:
9	Lit ●●●●●      Blink 9 times ○○●●● Return to beginning
10	Lit ●●●●●      Blink 1 time ●●○○○ Return to beginning
11	Lit ●●●●●      Blink 1 time ●●○○○      Blink 1 time ○○●●● Return to beginning
:	:
87	Lit ●●●●●      Blink 8 times ●●○○○      Blink 7 times ○○●●● Return to beginning

#### Volume indicator status

● Unlit      ○ Lit      ◐ Blink

3. While holding down the [Function] button, use the keyboard to specify the Bluetooth ID.

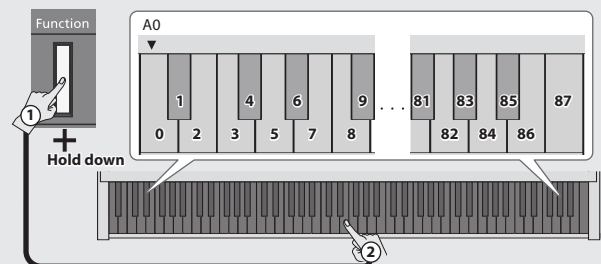

Value	Explanation
0–87	Set to "0": "FP-30X Audio" "FP-30X MIDI" (default value) Set to "1": "FP-30X Audio 1" "FP-30X MIDI 1"

The blinking of the Volume indicators changes according to the ID that you specify.

You can also use the [Slow]/ [Fast] buttons to change the **Bluetooth ID** value.

4. Press the [Volume] (left) button or [Volume] (right) button to complete the setting.

\* If you are pairing in an environment where there are multiple pianos, we recommend that you turn on the power of the mobile device and only those pianos that you want to pair (turn off the power of other devices).



# Advanced Operation

## Adjusting the Brilliance (Brilliance)

Here's how to adjust the brilliance of the sound (3 levels).

1. Hold down the [Function] button, and use the F5, F#5, or G5 keys of the keyboard to adjust the brilliance.

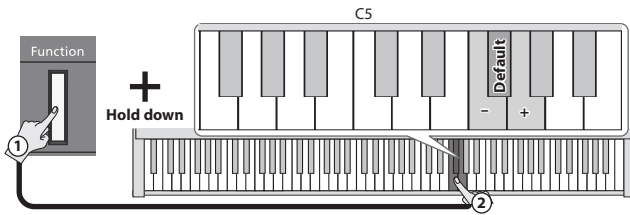

Key to press	Explanation
F5	Changes the brilliance value by -1.
F#5	Sets the brilliance value to the default value (0).
G5	Changes the brilliance value by +1.
Range of setting	-1→+1 (default: 0)

## Adjusting the Reverberation (Ambience)

You can adjust the depth of the acoustical ambience that simulates performing in a concert hall.

1. Hold down the [Function] button and use the C5, C#5, or D5 keys of the keyboard to adjust the ambience depth.

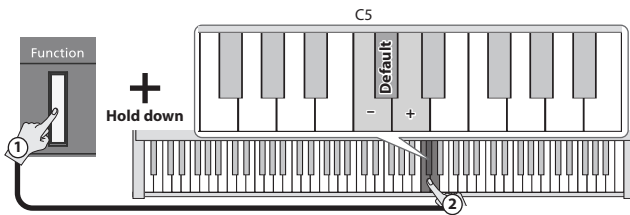

Key to press	Explanation
C5	Changes the ambience value by -1.
C#5	Sets the ambience value to the default value (1).
D5	Changes the ambience value by +1.
Range of setting	0-10 (default: 1)

## Dividing the Keyboard for Two People (Twin Piano)

You can divide the keyboard into left and right sections so that two people can play the same pitch ranges.

1. Hold down the [Function] button and use the G4, G#4, or A4 keys of the keyboard to adjust how Twin Piano is heard.

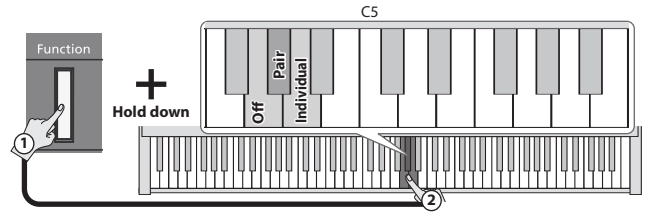

The keyboard will be divided into left and right sections, with "middle C" located in the center of each section.

Value	Explanation
Off	The same keyboard setting as a conventional acoustic piano.
Pair	The sound will be heard from the right as you play toward the right of the keyboard, and from the left as you play toward the left.
Individual	Notes played in the right area will be heard from the right speaker, and notes played in the left area will be heard from the left speaker.

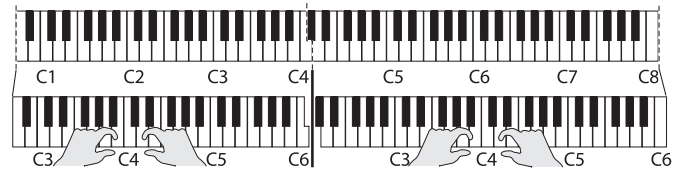

- \* The left and right sections will have the same tone (Piano). Twin Piano will be cancelled when you push one of the Tone buttons.
- \* The damper pedal applies only to the right section.
- \* When using the KPD-70, the soft pedal operates as the damper pedal for the left section, and the sostenuto pedal applies only to the right section.

## Convenient Metronome Functions

### Adjusting the Volume of the Metronome

You can adjust the volume of the metronome.

1. Hold down the [Metronome] button and use the C5, C#5, or D5 keys of the keyboard to adjust the volume of the metronome.

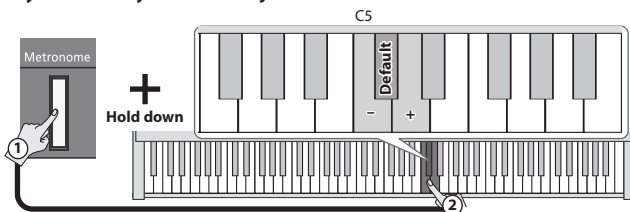

Key to press	Explanation
C5	Changes the metronome volume by -1.
C#5	Sets the metronome volume to the default value (5).
D5	Changes the metronome volume by +1.
Range of setting	1-10 (default: 5)

### Changing the Metronome's Tone

You can change the tone of the metronome.

1. Hold down the [Metronome] button and use the F5, F#5, G5, or G#5 keys of the keyboard to adjust the tone of the metronome.

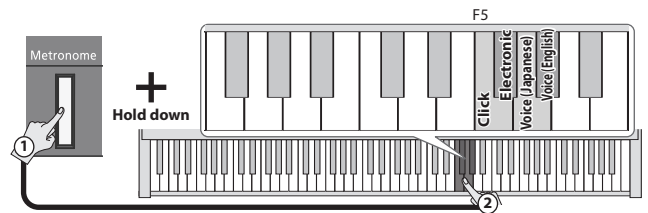

Value	Explanation
Click, Electronic, Voice (Japanese), Voice (English)	(default: Click)

#### MEMO

If "0" is selected as the time signature and "Voice" is selected as the metronome tone, it is heard at a time signature of 4/4.

English

日本語

Deutsch

Français

Italiano

Español

Português

Nederlands

简体中文

## Changing the Pitch of the Tone in Octave Steps (Octave Shift)

When using Dual Play (p. 2) or Split Play (p. 2), you can change the pitch of each sound in units of an octave. This is called "Octave Shift."

### Octave Shift in Dual Play

1. Put the piano in Dual Play mode, and select tones. The two Tone buttons of the selected sounds are lit.
2. Of the two lit Tone buttons, hold down the Tone button of the area whose octave you want to shift, and use the C6, C6#, or D6 keys of the keyboard to specify the amount of octave shift.

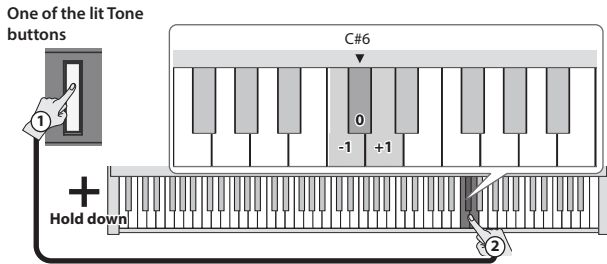

Key to press	Explanation
C6	Changes the octave shift value by -1.
C#6	Sets the octave shift value to the default value (0).
D6	Changes the octave shift value by +1.
Range of setting	-3+3 (default: 0)

### Octave Shift in Split Play

1. Put the piano in Split Play mode, and select tones. The [Split] button and the Tone button of the tone selected for the right hand are lit.
2. Hold down the lit Tone button, and use the C6, C6#, or D6 keys of the keyboard to specify the octave shift for the right-hand tone.

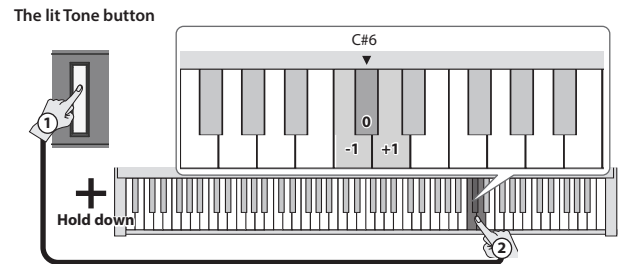

3. Hold down the [Split] button and the Tone button of the tone that you want to specify for the left hand, and use the C6, C#6, or D6 keys of the keyboard to specify the octave shift for the left-hand tone.

[Split] button and the Tone button that you want to specify for the left hand (in this example, Other)

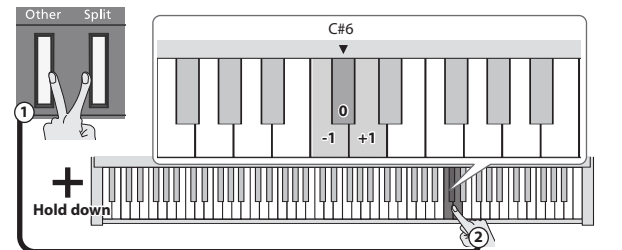

Key to press	Explanation
C6	Changes the octave shift value by -1.
C#6	Sets the octave shift value to the default value (0).
D6	Changes the octave shift value by +1.
Range of setting	-3+3 (default: 0)

## Sounding a Count Before Playback/Recording (Count-In)

A count that is sounded before song playback or recording begins is called a "count-in."

### Sounding a Count-In Before Song Playback

If a count is sounded in time with the song before playback begins, it's easier to match the timing of your own playing with the song.

1. Hold down the [Metronome] button and press the [▶/■] button. After the count-in is heard, the song plays.

### Sounding a Count-In Before Recording

\* In advance, sound the metronome, and set the time signature and tempo (p. 3).

1. Press the [●] button.
2. Press the [▶/■] button.

After the count-in (one measure by default) is heard, recording starts.

#### MEMO

If you play the keyboard instead of pressing the [▶/■] button, recording starts immediately, without sounding a count-in.

### Changing the Number of Count-In Measures

With the factory settings, the length of the count-in is set to one measure, but you are free to change the number of measures.

1. Hold down the [▶/■] button and press the C6 or C#6 key of the keyboard.

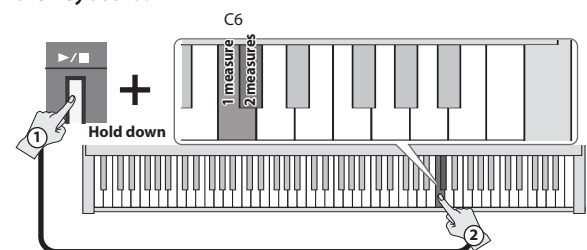

Key to press	Explanation
C6	Specifies a one-measure count-in (default).
C#6	Specifies a two-measure count-in.

## Outputting Sound Both from Headphones and Internal Speakers (Speaker Auto Mute)

With the factory settings, sound is no longer output from the internal speaker when you connect headphones to the Phones jack. However, you can change this setting so that sound is output both from the headphones and from the internal speakers.

- \* If this is "Off," the sound that is output from the headphones will have a different character.
- \* If this is "Off," sound is heard from the internal speakers even if the Speaker switch is "Off."

1. Hold down the [Volume](left) button and [Volume](right) button, and press the [Function] button.

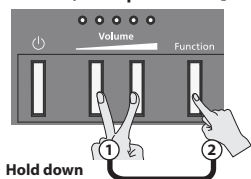

2. Press the [Function] button to switch the setting.

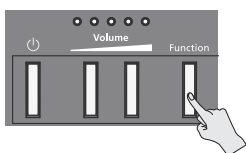

When headphones are connected to the Phones jack	Volume indicator status
<b>On</b> Sound is output only from the headphones (default)	
<b>Off</b> Sound is output both from the headphones and from the internal speakers	

3. To complete the operation, press either the [Volume](left) button or the [Volume](right) button.

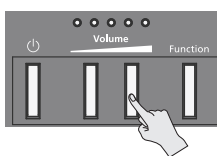

### Volume indicator status

- Unlit
- Lit
- ◐ Blink

## Formatting a USB Flash Drive

Before using a new USB flash drive with the FP-30X for the first time, you must format the USB flash drive.

### NOTE

- Formatting will erase everything that has been saved on the USB flash drive.



1. Connect the USB flash drive that you want to format to the USB Memory port.
2. While holding down the [▶/■] button, turn the power on. Keep holding down [▶/■] button for at least three seconds. The [▶/■] button and the [●] button will blink. If you decide to cancel, press the [▶/■] button.
3. To execute the format, press the [●] button. When all the LEDs on the buttons are lit, the operation is complete.
4. Turn the power off, then on again.

## Saving the Settings (Memory Backup)

This piano remembers the "settings that are saved automatically" even when the power is turned off and then on again. If you set the "Memory Backup" setting, the settings saved by "memory backup" are also saved. Other settings return to their default values when you turn the power off and on again.

1. Hold down the [Function] button and press the [●] button. The [▶/■] button and the [●] button will blink. If you decide to cancel, press the [▶/■] button.

2. To save the settings, press the [●] button.

When all the LEDs on the buttons are lit, the operation is complete.

### Settings that are saved by "Memory Backup"

Settings saved by Memory Backup	Page
Key Touch	p. 12
Brilliance	p. 9
Ambience	p. 9
Master Tuning	p. 12
Speaker Switch (only "Stand" and "Desk")	p. 12
Speaker Auto Mute	p. 11
Metronome Volume	p. 9
Metronome Tone	p. 9
Count In Measure	p. 10

### Settings that are saved automatically

Settings saved automatically	Page
Bluetooth On/Off	p. 12
Input Volume	p. 12
Auto Off	p. 5

## Restoring the Factory Settings (Factory Reset)

Here's how to restore all registrations and internally saved settings to the factory-set condition. This function is called "Factory Reset."

### NOTE

When you execute a factory reset, all settings will be initialized and the song you recorded in internal memory will be erased.

1. While holding down the [Function] button, turn the power on. Keep holding down [Function] button for at least three seconds. The [▶/■] button and the [●] button will blink. If you decide to cancel, press the [▶/■] button.

2. To execute the Factory Reset, press the [●] button.

When all the LEDs on the buttons are lit, the operation is complete.

3. Turn the power off, then on again.

Various Function Settings (Function Mode)



To make function settings, hold down the [Function] button and press the key shown in the illustration.

+ Hold down ②

C8

Off

240 min.

30 min.

10 min.

Desk

Stand

Off

Auto Off (p. 5)

Speaker Switch

C7

+

Playback

-

USB Flash Drive Songs

+

440.0 Hz

-

Master Tuning

+

Medium

-

Key Touch

C6

+

Default

-

Brilliance (p. 9)

+

Default

-

Ambience (p. 9)

C5

Individual

Pair

Off

+5

+4

+3

+2

+1

0

-1

-2

-3

-4

-5

-6

Twinpiano (p. 9)

Transpose

C4

16

15

14

13

12

11

10

9

8

7

6

5

4

3

2

1

MIDI Transmit Channel

C3

External

Internal

Auto-Select

SMF Play Mode

C2

Off

On

Local Control

+

Default

-

Input Volume

C1

Off

On

Bluetooth (p. 6)

Changing the Internal Speaker Settings (Speaker Switch)

You can specify how the internal speakers are heard.

Setting	Explanation
Off	Sound is not output from the internal speakers; sound is output only from the Output jacks. This is convenient when you're using the piano in a live performance. * The state of the "Off" is not saved by memory backup.
Stand (default)	Sound is output both from the internal speakers and from the Output jacks. The character of the sound is adjusted optimally for when the piano is played while placed on a stand.
Desk	Sound is output both from the internal speakers and from the Output jacks. The character of the sound is adjusted optimally for when the piano is played while placed on a table.

Regardless of this setting, sound is not output from the internal speakers if headphones are connected to the Phones jack. If you want the internal speakers to output sound even when headphones are connected, see the following reference (p. 11).

Playing Songs from a USB Flash Drive

You can play songs from a USB flash drive, or switch songs.

Matching the Pitch with Other Instruments (Master Tuning)

When playing ensemble with other instruments and in other such instances, you can match the standard pitch to another instrument.

The standard pitch generally refers to the pitch of the note that's played when you finger the middle A key. For a cleaner ensemble sound while performing with one or more other instruments, ensure that each instrument's standard pitch is in tune with that of the other instruments. This tuning of all the instruments to a standard pitch is called "master tuning."

You can adjust the tuning in the range of 415.3 Hz–440.0 Hz (default)–466.2 Hz (in 0.1 Hz steps).

Changing the Keyboard Playing Feel (Key Touch)

You can change the playing feel of the keyboard.

Setting	Explanation
+2: Super Heavy	An even heavier setting than "Heavy."
+1: Heavy	You have to finger the keyboard more forcefully than "Medium" in order to play fortissimo (ff), so the keyboard touch feels heavier.
0: Medium	Sets the keyboard to the standard touch.
-1: Light	You can achieve fortissimo (ff) play with a less forceful touch than "Medium" so the keyboard feels lighter.
-2: Super Light	An even lighter setting than "Light."
-3: Fix	The sound plays at one set volume, regardless of the force used to play the keys.

Changing the Key of the Keyboard (Transpose)

You can use the Transpose function to transpose the keyboard in semitone steps.

For example, if a song is in the key of E major, and you want to play it with the fingering of C major, set Transpose to a value of "+4."

If you play C E G It will sound E G# B

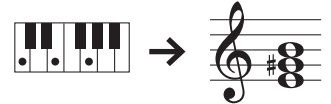

Setting the MIDI Transmit Channel

You can specify this piano's MIDI transmit channel.

MIDI uses sixteen channels, 1–16. By connecting this piano to another MIDI device and setting both devices to the same MIDI channel, you can play sounds or switch sounds on that device. This piano receives all channels 1–16.

Setting the Song (SMF) Playback Mode (SMF Play Mode)

This setting specifies the tone that you play on the keyboard while a song is playing back. Normally you will use the "Auto-Select" setting. This determines whether the setting that is most suitable for the internal song or most suitable for external data is selected when you play back a song whose file format is SMF.

Changing this setting does not affect the sound character of tone that you play from the keyboard.

Setting	Explanation
External	The tone that you play from the keyboard does not change when you play back a song. This is recommended when you play back external data such as commercially available music data. * With this setting, some effects might not apply to the song playback sound. For this reason, the character of the sound during playback might be different than the sound while you were recording.
Internal	When you play back a song, the tone that you play from the keyboard changes to the tone that is saved in the song. This is recommended when you play back an internal song or a song that you recorded on this piano.
Auto-Select	Automatically switches the SMF Play Mode to either "Internal" or "External" depending on the song that is being played.

Preventing Double Notes When Working with a Software Synthesizer (Local Control)

When you have a MIDI sequencer connected, set this parameter to Local Off.

Since most sequencers have their Thru function turned on, notes you play on the keyboard may be sounded in duplicate, or get dropped. To prevent this, you can enable the "Local Off" setting so that the keyboard and internal sound generator will be disconnected.

Adjusting the Bluetooth/USB Audio Volume

You can adjust the volume of the audio signal that is sent from Bluetooth or the USB Computer port.

Input Volume	1–10 (default: 7)
--------------	-------------------

Setting the Bluetooth Function

Setting	Explanation
On (default), Off	Turns the Bluetooth function on/off.

# 🎵 Troubleshooting

Problem	Cause/Action
All LEDs other than the [⏻] (Power) button are blinking	Excessive current flow occurred at the USB Memory port. Check whether there might be a problem with the USB flash drive. Next, turn the power off, then back on again.
Even though you're using headphones to mute the sound, a thumping sound is heard when you play the keyboard	The keyboard of this piano is designed to simulate the mechanism of an acoustic piano. Even on an acoustic piano, a thumping sound is actually being produced when you press a key. Such sounds do not indicate a malfunction.
Power turns off on its own	With the factory settings, the unit's power will automatically be switched off 240 minutes after you stop playing or operating the unit. If you don't need the power to turn off automatically, turn the "Auto Off" setting "Off" (p. 5). In some cases, playing back extremely high-volume SMF or WAV data from a USB flash drive may cause the protection circuit to operate, turning the power off. If this occurs, reduce the volume.
Power does not turn on	Is the AC adaptor connected correctly (p. 5)?
Pedal does not work, or is "stuck"	Is the pedal connected correctly? Plug the cord firmly into the Pedal jack (p. 5). Could the unit's volume be turned down?
No sound/No sound when you play back a song	Could headphones be connected? The speakers will not produce sound if headphones is connected to the Phones jack (p. 4) (p. 11).
Pitch of the keyboard or song is incorrect	Could you have made Transpose settings (p. 12). Is the Master Tune setting appropriate (p. 12). The notes of a piano are tuned using a unique method (stretched tuning), which makes upper-range notes slightly higher in pitch, and lower-range notes slightly lower in pitch. For this reason, you might perceive the pitch as being incorrect, but this is the way an acoustic piano should sound.
Sounds are heard two tones when the keyboard is played	Could you have selected a dual tone (p. 2)?

Problem	Cause/Action
The sound of the higher notes suddenly changes from a certain key	On an acoustic piano, the approximately one and a half octaves of notes at the upper end of the keyboard will continue sounding regardless of the damper pedal. These notes also have a somewhat different tonal character. This unit faithfully simulate this characteristic of acoustic pianos. On this unit, the range that is unaffected by the damper pedal will change according to the transpose setting.
High-pitched ringing is heard	<b>If you hear this in headphones:</b> Piano sounds that have a brilliant and crisp character contain substantial high-frequency components that may sound as though a metallic ringing has been added. This is because the characteristics of an actual piano are being faithfully reproduced, and is not a malfunction. This ringing is more obtrusive if the ambience is applied heavily, so you may be able to minimize it by decreasing the ambience (p. 9). <b>If you don't hear this in headphones:</b> It is likely that there is some other reason (such as resonances within the unit). Please contact your dealer or Roland Support.
Low sound wrong, or are buzzy	If you set the volume to the maximum setting, the sound may be distorted depending on how you perform. If this occurs, turn down the volume. If you don't hear this in headphones: Performing at high volumes may cause the speakers or objects near the unit to resonate. Fluorescent lights or glass doors may also resonate sympathetically. In particular, this is more likely to occur for lower notes and higher volumes. You can take the following measures to minimize resonances. <ul style="list-style-type: none"> <li>• Locate this unit 30 cm (12 inch) away from walls or other surfaces.</li> <li>• Keep the volume down.</li> <li>• Move away from the objects that are resonating.</li> </ul> <b>If you hear this in headphones:</b> It is likely that there is some other reason. Please contact your dealer or Roland Support.

# 🎵 Internal Song List

No.	Song Name	Composer	Key
1	Elevations	* Original	A0
2	Reflection	* Original	A#0
3	Fly day	* marasy	B0
4	Barcarolle	* Fryderyk Franciszek Chopin	C1
5	Zhavoronok	* "Mikhail Ivanovich Glinka, Arranged by Mily Alexeyevich Balakirev"	C#1
6	Valse, op.34-1	* Fryderyk Franciszek Chopin	D1
7	Polonaise op.53	* Fryderyk Franciszek Chopin	D#1
8	Nocturne No.20	* Fryderyk Franciszek Chopin	E1
9	Die Forelle	* Franz Peter Schubert, Arranged by Franz Liszt	F1
10	Reflets dans l'Eau	* Claude Achille Debussy	F#1
11	Polovtsian Dances	Alexander Borodin	G1
12	Ombra mai fu	George Frideric Handel	G#1
13	Lascia ch'io pianga	George Frideric Handel	A1
14	Twinkle Twinkle Little Star	French Folk Song	A#1
15	Mary Had a Little Lamb	Traditional	B1
16	Bear Song	American Folk Song	C2
17	Ich Bin Ein Musikante	German Folk Song	C#2
18	Grand Father's Clock	Henry Work	D2
19	Jingle Bells	James Pierpont	D#2
20	We Wish You a Merry Christmas	Carol	E2
21	Silent Night	Franz Gruber	F2
22	Amazing Grace	Hymn	F#2

No.	Song Name	Composer	Key
23	Lavender's Blue	Traditional	G2
24	Aura Lee	George R. Poulton	G#2
25	Auld Lang Syne	Traditional	A2
26	Greensleeves	Traditional	A#2
27	Maple Leaf Rag	Scott Joplin	B2
28	The Entertainer	Scott Joplin	C3
29	When The Saints Go Marching In	Traditional	C#3
30	Little Brown Jug	Joseph Winner	D3
---	(Recorded song)	---	C4

- \* All rights reserved. Unauthorized use of this material for purposes other than private, personal enjoyment is a violation of applicable laws.
- \* Performance data of the tone demos and the built-in songs is not output from the USB Computer port or from **Bluetooth** (MIDI).
- \* If the SMF playback mode (p. 12) is set to "Auto-Select" or "Internal," there will be some parts whose volume is not changed by the [Song Volume]. If you set the SMF playback mode to "External," the volume of all parts will change.
- \* Songs marked by an asterisk (\*) are piano solo songs. They have no accompaniment.
- \* "Fly day" are played by marasy

English

日本語

Deutsch

Français

Italiano

Español

Português

Nederlands

简体中文

# USING THE UNIT SAFELY

## WARNING

### Concerning the Auto Off function

The power to this unit will be turned off automatically after a predetermined amount of time has passed since it was last used for playing music, or its buttons or controls were operated (Auto Off function). If you do not want the power to be turned off automatically, disengage the Auto Off function (p. 5).



### Use only the stand that is recommended

This unit should be used only with a stand that is recommended by Roland.



### Do not place in a location that is unstable

When using the unit with a stand recommended by Roland, the stand must be carefully placed so it is level and sure to remain stable. If not using a stand, you still need to make sure that any location you choose for placing the unit provides a level surface that will properly support the unit, and keep it from wobbling.



### Precautions regarding placement of this unit on a stand

Be sure to follow the instructions in the Owner's Manual carefully when placing this unit on a stand (p. 4).



If it is not set up properly, you risk creating an unstable situation which could lead to the unit falling or the stand toppling, and may result in injury.

## WARNING

### Use only the supplied AC adaptor and the correct voltage

Be sure to use only the AC adaptor supplied with the unit. Also, make sure the line voltage at the installation matches the input voltage specified on the AC adaptor's body. Other AC adaptors may use a different polarity, or be designed for a different voltage, so their use could result in damage, malfunction, or electric shock.



### Use only the supplied power cord

Use only the attached power cord. Also, the supplied power cord must not be used with any other device.



## CAUTION

### Use only the specified stand(s)

This unit is designed to be used in combination with specific stands (\*1) manufactured by Roland. If used in combination with other stands, you risk sustaining injuries as the result of this product dropping down or toppling over due to a lack of stability.



\*1 KSC-70, KS-12, KS-20X, KS-10Z

## CAUTION

### Evaluate safety issues before using stands

Even if you observe the cautions given in the owner's manual, certain types of handling may allow this product to fall from the stand, or cause the stand to overturn. Please be mindful of any safety issues before using this product.



### Cautions when moving this unit

Since this product is very heavy, you must make sure that a sufficient number of people are on hand to help, so you can lift and move it safely, without causing strain. Make sure to have a firm grip, to protect yourself from injury and the instrument from damage. If you need to move the instrument, take note of the precautions listed below.



- Check to make sure the screw securing the unit to the stand have not become loose. Fasten them again securely whenever you notice any loosening.
- Disconnect the power cord.
- Disconnect all cords coming from external devices.
- Remove the music stand.

# IMPORTANT NOTES

## Placement

- Do not allow objects to remain on top of the keyboard. This can be the cause of malfunction, such as keys ceasing to produce sound.
- Depending on the material and temperature of the surface on which you place the unit, its rubber feet may discolor or mar the surface.

## Care of the Keyboard

- Do not write on the keyboard with any pen or other implement, and do not stamp or place any marking on the instrument. Ink will seep into the surface lines and become unremovable.
- Do not affix stickers on the keyboard. You may be unable to remove stickers that use strong adhesives, and the adhesive may cause discoloration.
- To remove stubborn dirt, use a commercially available keyboard cleaner that does not contain abrasives. Start by wiping lightly. If the dirt does not come off, wipe using gradually increasing amounts of pressure while taking care not to scratch the keys.

## Repairs and Data

- Before sending the unit away for repairs, be sure to make a backup of the data stored within it; or you may prefer to write down the needed information. Although we will do our utmost to preserve the data stored in your unit when we carry out repairs, in some cases, such as when the memory section is physically damaged, restoration of the stored content may be impossible. Roland assumes no liability concerning the restoration of any stored content that has been lost.

## Additional Precautions

- Any data stored within the unit can be lost as the result of equipment failure, incorrect operation, etc. To protect yourself against the irremovable loss of data, try to make a habit of creating regular backups of the data you've stored in the unit.
- Roland assumes no liability concerning the restoration of any stored content that has been lost.
- The sound of keys being struck and vibrations produced by playing an instrument can be transmitted through a floor or wall to an unexpected extent. Please take care not to cause annoyance to others nearby.
- Do not apply undue force to the music stand while it is in use.

## Using External Memories

- Please observe the following precautions when handling external memory devices. Also, make sure to carefully observe all the precautions that were supplied with the external memory device.
  - Do not remove the device while reading/writing is in progress.
  - To prevent damage from static electricity, discharge all static electricity from your person before handling the device.

## Caution Regarding Radio Frequency Emissions

- The following actions may subject you to penalty of law.
  - Disassembling or modifying this device.
  - Removing the certification label affixed to the back of this device.
  - Using this device in a country other than where it was purchased

## Intellectual Property Right

- It is forbidden by law to make an audio recording, video recording, copy or revision of a third party's copyrighted work (musical work, video work, broadcast, live performance, or other work), whether in whole or in part, and distribute, sell, lease, perform or broadcast it without the permission of the copyright owner.
- Do not use this product for purposes that could infringe on a copyright held by a third party. We assume no responsibility whatsoever with regard to any infringements of third-party copyrights arising through your use of this product.
- The copyright of content in this product (the sound waveform data, style data, accompaniment patterns, phrase data, audio loops and image data) is reserved by Roland Corporation.
- Purchasers of this product are permitted to utilize said content (except song data such as Demo Songs) for the creating, performing, recording and distributing original musical works.
- Purchasers of this product are NOT permitted to extract said content in original or modified form, for the purpose of distributing recorded medium of said content or making them available on a computer network.
- This product contains eParts integrated software platform of eSOL Co., Ltd. eParts is a trademark of eSOL Co., Ltd. in Japan.
- The **Bluetooth**® word mark and logos are registered trademarks owned by **Bluetooth SIG, Inc.** and any use of such marks by Roland is under license.
- This Product uses the Source Code of  $\mu$ T-Kernel under T-License 2.0 granted by the T-Engine Forum ([www.tron.org](http://www.tron.org)).
- This product includes third party open source software.
  - Copyright © 2009-2018 Arm Limited. All rights reserved. Copyright © 2018 STMicroelectronics. All rights reserved. Licensed under the Apache License, Version 2.0 (the "License"); You may obtain a copy of the License at <http://www.apache.org/licenses/LICENSE-2.0>
  - Copyright © 2018 STMicroelectronics. All rights reserved. This software component is licensed by ST under BSD 3-Clause license, the "License"; You may obtain a copy of the License at <https://opensource.org/licenses/BSD-3-Clause>
  - This product is using the Jansson (<http://www.digip.org/jansson/>) source code. Copyright © 2009-2016 Petri Lehtinen <[petri@digip.org](mailto:petri@digip.org)> Released under the MIT license <http://opensource.org/licenses/mit-license.php>
- Roland and SuperNATURAL are either registered trademarks or trademarks of Roland Corporation in the United States and/or other countries.
- Company names and product names appearing in this document are registered trademarks or trademarks of their respective owners.

# Main Specifications

## Roland FP-30X: Digital Piano

Sound generator	Piano Sound: SuperNATURAL Piano
Keyboard	88 keys (PHA-4 Standard Keyboard: with Escapement and Ivory Feel)
Bluetooth	<b>Bluetooth</b> Ver 4.2 Supported profiles: A2DP (Audio), GATT (MIDI over <b>Bluetooth</b> Low Energy) Supported codec: SBC (compatible with SCMS-T content protection)
Power Supply	AC Adaptor
Power consumption	16 W (When using the included AC adaptor) * Approximate power consumption when playing the piano at medium volume: 4 W Power consumption when sound has not been played after power-on: 3 W
Dimensions	With music rest detached: 1,300 (W) x 284 (D) x 151 (H) mm 51-3/16 (W) x 11-3/16 (D) x 6 (H) inches With music rest and dedicated stand KSC-70: 1,300 (W) x 344 (D) x 931 (H) mm 51-3/16 (W) x 13-9/16 (D) x 36-11/16 (H) inches
Weight	14.8 kg, 32 lbs 11 oz (with music rest) 23.0 kg, 50 lbs 12 oz (with KSC-70, KPD-70 and music rest)
Accessories	Owner's Manual Leaflet "USING THE UNIT SAFELY" Music Rest AC Adaptor Power Cord (for connecting AC Adaptor) Pedal switch (DP-2)
Options	Dedicated stand: KSC-70 Dedicated pedal board: KPD-70 Keyboard stand: KS-10Z, KS-12, KS-20X Damper pedal: DP series Carrying Bag: CB-88RL, CB-76RL, CB-B88V2, SC-G76W3 Headphones

\* This document explains the specifications of the product at the time that the document was issued. For the latest information, refer to the Roland website.

## Formats Playable from a USB Flash Drive

The FP-30X can play back data in the following formats.

- SMF format 0/1
- Audio data (WAV format, 44.1 kHz, 16-bit linear)
- Audio data (MP3 format, 44.1 kHz, 64 kbps–320 kbps)

English

日本語

Deutsch

Français

Italiano

Español

Português

Nederlands

简体中文

# List of Operations (Button and Key Combinations)

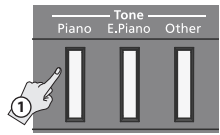

Hold down ②

C8	
C7	
C6	
C5	
C4	
C3	
C2	
C1	

- Split/Dual octave shift**  
→ p. 10
- Dual mix balance**  
→ p. 2
- Split mix balance**  
→ p. 2

**Tone select**  
→ p. 2

Piano  
E. Piano  
Other



Hold down ②

C8	
C7	
C6	
C5	
C4	
C3	
C2	
C1	

- Metronome tone**  
→ p. 9
- Metronome Volume**  
→ p. 9
- Typical tempo**
- Enter tempo numerically**  
→ p. 3
- Change the time signature**  
→ p. 3

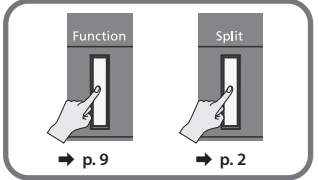

Hold down ②

C8	Playback	<b>All Song Play</b>
C7	Playback + -	<b>USB flash drive songs</b>
C6	2 measures 1 measure	<b>Count-In Measures</b> → p. 10
C5	Default + -	<b>Song Volume</b>
C4	Playback	<b>Recorded song</b>
C3	30 29 28 27 26 25 24 23 22 21 20 19 18 17 16 15 14 13 12 11 10 9 8 7 6 5 4 3 2 1	<b>Song select</b> → p. 3
C2		
C1		



# Internal Song Music Book

## 内蔵曲楽譜集

1 : Elevations  
2 : Reflection

**FP-90X**  
**FP-60X**  
**FP-30X**  
Roland Digital Piano

# Elevations

Original

Allegro (♩ = ca.140)

The musical score is written for piano in 3/4 time. It consists of four systems of music, each with a treble and bass clef staff. The first system starts with a tempo marking of 'Allegro (♩ = ca.140)' and a dynamic of 'mf playful'. The second system includes a 'rit.' marking. The third system is marked 'a tempo'. The fourth system includes 'poco rit.' and 'mp' markings. Chord symbols are placed above the treble staff, and 'Ped.' markings are placed below the bass staff. The score is titled 'Elevations' and is identified as the 'Original' version.

Chords: C, C6, G7/C, Dm, G9, Am, C/G, F, C/G, G, C, F/A, C/G, F6, Dm7, C, G, C.

Dynamics: *mf playful*, *rit.*, *a tempo*, *poco rit.*, *mp*.

Tempo: Allegro (♩ = ca.140), *a tempo*.

Other markings: Ped., *mf playful*, *rit.*, *a tempo*, *poco rit.*, *mp*.

C Cmaj7 Am

And.

C/B C Cmaj7

And.

Am C/B Poco slower

And.

Fmaj7 C/G G Fmaj7

*mf* *expressivo*

And.

Gsus4 G C Più mosso Dm/A Fmaj7

And.

First system of a piano score. The treble clef staff contains chords and melodic lines. The bass clef staff contains a bass line with a 'Ped.' marking. Chords are labeled: C/E, F6, Am7, and F/A.

Second system of a piano score. The treble clef staff contains chords and melodic lines. The bass clef staff contains a bass line with a 'Ped.' marking. Chords are labeled: A<sup>b</sup>maj7, Fm6, C/G *a tempo*, and G. Dynamics include *f rit.* and *mf*.

Third system of a piano score. The treble clef staff contains chords and melodic lines. The bass clef staff contains a bass line with a 'Ped.' marking. Chords are labeled: G, Fmaj7, and G. A *rit.* marking is present.

Fourth system of a piano score. The treble clef staff contains chords and melodic lines. The bass clef staff contains a bass line with a 'Ped.' marking. Chords are labeled: C, Cmaj7, and Am. The tempo is marked **Tempo I** and the mood is *playful*.

Fm6 *a tempo* C/G Gsus4

*poco rit.* *expressivo*

Detailed description: This system shows the beginning of a piano piece. The right hand starts with a melodic line in the treble clef, and the left hand provides harmonic support in the bass clef. The first measure has a chord of Fm6. The tempo is marked 'a tempo'. The second measure has a chord of C/G. The third measure has a chord of Gsus4. Performance directions include 'poco rit.' and 'expressivo'.

G Fmaj7 C/G G

Detailed description: This system continues the piano accompaniment. The right hand has a melodic line, and the left hand has a bass line. The chords are G, Fmaj7, C/G, and G. The bass line features a walking bass pattern.

A<sup>b</sup>maj7 **Più mosso** B<sup>b</sup>6

Detailed description: This system marks a change in tempo to 'Più mosso'. The right hand has a melodic line, and the left hand has a bass line. The chords are A<sup>b</sup>maj7 and B<sup>b</sup>6. The bass line features a walking bass pattern.

A<sup>b</sup>maj7 B<sup>b</sup>6 *poco rit.*

Detailed description: This system continues the piano accompaniment. The right hand has a melodic line, and the left hand has a bass line. The chords are A<sup>b</sup>maj7 and B<sup>b</sup>6. The tempo is marked 'poco rit.'.

C

Detailed description: This system shows the final part of the piano accompaniment. The right hand has a melodic line, and the left hand has a bass line. The chord is C. The bass line features a walking bass pattern.

# Reflection

Original

Moderate (♩ = ca.112)

C

*mf*

Ped. Ped.

Am F F6 Fmaj7 Dm7

Ped. Ped. Ped.

C

Ped. Ped.

F G F/A G7/B

Ped. Ped. Ped. Ped.

C

Ad. Ad.

Am G/B F#m7<sup>b</sup>5 F

*a tempo*

*poco rit.*

Ad. Ad. Ad. Ad.

C E<sup>b</sup>6

Ad. Ad.

C E<sup>b</sup>6

*poco rit.*

Ad. Ad.

C

Ad.

