

# KAWAI

## DIGITAL PIANO CA401 Owner's Manual

Important Information

Preparation

Basic Operation

Adjustments & Settings

Appendix

EN

# Important Safety Instructions

Be sure to read these Safety Precautions carefully before using this instrument to ensure correct use.



When using this electronic musical instrument, please observe the following precautions for safety.  
When this instrument is used by small children, please ensure safe use under the supervision of a parent.



## Warnings, cautions, and symbols have the following meanings



**CAUTION:**







TO REDUCE THE RISK OF ELECTRIC SHOCK, DO NOT DISASSEMBLE THE MAIN UNIT OF THIS INSTRUMENT. NO USER-SERVICEABLE PARTS INSIDE. REFER SERVICING TO QUALIFIED SERVICE PERSONNEL.





 <p><b>WARNING</b></p> <p>Describes a potential hazard that could result in death or serious injury if the indication is ignored and this instrument is handled incorrectly.</p>
 <p><b>CAUTION</b></p> <p>Describes a potential hazard that could result in injury or damage to property if the indication is ignored and this instrument is handled incorrectly.</p>

	denotes that care (precaution) should be taken.
	denotes a prohibited operation (an operation that must not be done).
	denotes an instruction (an operation that should be carried out) or indicative notice.

## **WARNING**

Doing so may cause an electric shock, fire, injury, fall, damage, or breakdown.

-  The product should be connected to an AC outlet of the specified voltage.
-  The included power cable is only for use with this instrument.
-  Do not forcibly bend, place a heavy object on, bring a high-temperature object close to, or damage the power cable and AC adapter cable.
-  Do not bring the AC adaptor close to a high temperature object or use in a manner that heat accumulates.
-  If dust accumulates on the power plug, wipe it clean with a cloth.
-  Do not disassemble, repair, or modify this instrument.
-  Do not insert or pull out the power plug with wet hands.

-  Do not get this instrument wet.
  -  When disconnecting the power cable plug, always hold the plug and pull out.
  -  Disconnect the power cable during lightning storms or when this instrument is unused for long periods of time.
  -  Should an abnormality occur in this instrument, immediately turn the power off and disconnect the power plug from the outlet.
- When any of the following cases occur, this instrument may have broken down. In such a case, do not use this instrument, keep the power cable disconnected from the outlet, and contact the shop from which the product was purchased.
1. Foreign objects fell into the instrument.
  2. Water was spilled into the instrument.
  3. Some parts of the instrument or accessory became abnormally hot.
  4. Unusual smell or smoke occurred.



## CAUTION

Doing so may cause a fall, damage, breakdown, injury, Health damage.



Keep the power cable plug in a state where it can be disconnected from the outlet easily.

This instrument is not completely shut-off from the power supply even when the power switch is turned off.



To shut-off completely, disconnect the power plug from the outlet.



When using the headphones, do not listen for long periods of time at high volume levels.



Do not run around this instrument.



Do not drop this instrument or apply a large impact.

Do not use this instrument in the following areas.

1. Areas where the floor is unstable and the instrument becomes wobbly.
2. Areas that become wet.
3. Extremely hot or cold areas.
4. Extremely humid or dry areas.
5. Areas where the instrument is exposed to direct sunlight, such as those near a window.
6. Areas where a large amount of sand or dust is present.
7. Areas where the instrument is exposed to excessive vibrations.



Do not use anything other than the company's optional stand.



Do not press your fingernails, sharp objects, or hard objects strongly against the surface of the display.



Do not stand on, hang down from, or push this instrument.



Read the assembly instructions in advance before assembling this instrument and bench (if included).



Regularly inspect the screws used to assemble this instrument and bench (if included) for looseness, and retighten if necessary.



The height adjustment of the bench (if included) should be performed when no one is sitting on it.



Keep small parts out of the reach of children.



When moving this instrument, always lift in a horizontal direction by two or more people.



Piano should be placed in a location such that its position does not affect its own ventilation.



Keep a minimum distance of 5 cm around the instrument for sufficient ventilation.



Do not put any part of your body under the keyboard cover, music stand, or pedals.



Do not put any part of your body under the music stand or pedals.

## Nameplate location

The information, including model name and serial number, is specified on the nameplate located on the underside of the instrument.

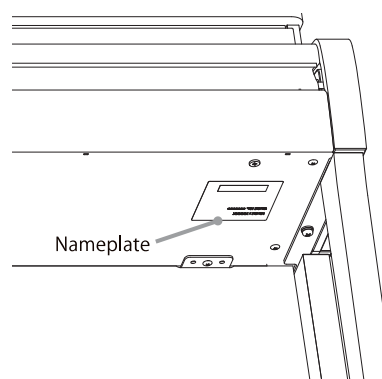

# Règles de sécurité (Supplémentaires pour le Canada)

## Exemples de symboles graphiques



### AVERTISSEMENT

Indique un risque potentiel qui peut entraîner la mort, ou de graves lésions, si l'appareil n'est pas manipulé correctement.



### PRECAUTION

Indique un risque potentiel qui peut entraîner la détérioration, ou des dommages, pour l'appareil ou ses propriétés, si celui-ci n'est pas manipulé correctement.



Indique que des précautions doivent être prises.



Indique une manipulation interdite.



Indique qu'une manipulation doit être effectuée.



## AVERTISSEMENT

Cela constitue un risque de choc électrique, d'incendie, de blessures, de chute, de dégâts ou de panne.



Faite attention de ne pas introduire un produit étranger à l'intérieur de l'appareil.



Ne jamais placer sur le produit des objets contenant des liquides, tels que des vases ou autres récipients.



Ce produit n'est pas totalement déconnecté du circuit électrique lorsqu'il est mis hors tension par le bouton d'arrêt. Si l'appareil ne doit pas être utilisé pendant une longue période, débranchez le câble d'alimentation de la prise secteur.



Il est recommandé de placer l'instrument à proximité de la prise de courant et de positionner le câble d'alimentation secteur de sorte qu'il puisse être débranché rapidement en cas d'urgence, le courant électrique étant toujours présent tant que la prise est branchée même si le bouton de mise en marche est en position Arrêt.



## ATTENTION

Cela constitue un risque de chute, de dégâts, de panne, de blessures, d'effet nocif sur la santé.



Description de la l'emplacement de la référence (Le cas échéant):

Anglais phrase: The nameplate label is located on the underside of the instruments, as indicated below.

Français phrase: La référence commerciale est inscrite sur une étiquette en dessous de votre instrument, conformément à l'indication ci-dessous.



Votre piano doit être placé à un endroit tel que sa position n'altère pas sa propre ventilation. Gardez une distance minimum de 5 cm autour de l'instrument pour une aération suffisante.

## Notes on Repair

Should an abnormality occur in the product, immediately turn the power OFF, disconnect the power cable plug, and then contact the shop from which the product was purchased.

## Information on disposal for users



If your product is marked with this recycling symbol it means that, at the end of its life, you must dispose of it separately by taking it to an appropriate collection point. You should not mix it with general household waste. Disposing of this product correctly will prevent potential negative effects on the environment and human health which could otherwise arise due to inappropriate waste handling. For further details, please contact your local authority. (European Union only)

## FCC Information (U.S.A)

### Caution :

Changes or modifications not expressly approved by KAWAI could void the user's authority to operate the equipment.

### Note :

This equipment has been tested and found to comply with the limits for a Class B digital device, pursuant to Part 15 of the FCC Rules. These limits are designed to provide reasonable protection against harmful interference in a residential installation. This equipment generates, uses and can radiate radio frequency energy and, if not installed and used in accordance with the instructions, may cause harmful interference to radio communications. However, there is no guarantee that interference will not occur in a particular installation. If this equipment does cause harmful interference to radio or television reception, which can be determined by turning the equipment off and on, the user is encouraged to try to correct the interference by one or more of the following measures:

- Reorient or relocate the receiving antenna.
- Increase the separation between the equipment and receiver. Connect the equipment into an outlet on a circuit different from that to which the receiver is connected.
- Consult the dealer or an experienced radio/TV technician for help.

## Supplier's Declaration of Conformity

Products : Electronic Piano

Model Number : CA401

Responsible Party Name : Kawai America Corporation

Address : 2055 East University Drive Rancho Dominguez, CA 90220

Telephone : 310-631-1771

This device complies with Part 15 of the FCC Rules. Operation is subject to the following two conditions:

(1) this device may not cause harmful interference, and

(2) this device must accept any interference received, including interference that may cause undesired operation.

This applies only to products distributed by Kawai America Corporation.

# Introduction

Thank you for purchasing this digital piano. In order to fully enjoy this instrument and use it for a long time, please carefully read this owner's manual and store it together with the warranty in a safe place for future reference.







## About this owner's manual

- The owner's manual provides basic operation guides necessary to use this instrument immediately, as well as explanations of operations for mastering various functions.
- The display illustrations and functions shown in this manual may differ from those on the actual instrument depending on the version.

## About intellectual property rights

- The **Bluetooth®** word mark and logos are registered trademarks owned by the Bluetooth SIG, Inc. and any use of such marks by Kawai Musical Instruments Mfg. Co., Ltd. is under license.
- "MIDI" is a registered trademark of the Association of Musical Electronics Industry (AMEI).
- Windows is a registered trademark of Microsoft Corporation.
- Mac is a registered trademark of Apple Inc.
- All other company and product names described in this manual are trademarks or registered trademarks of their respective owners.
- Use of existing copyrighted material such as commercially available CDs, music files, and standard MIDI files (SMF) with this instrument, whether for personal or private use within the home, is subject to copyright law and may not exceed the scope of acceptable use without the permission of the copyright holder. Kawai Musical Instruments Mfg. Co., Ltd. assumes no responsibility for any uses or acts that violate copyright law.

## About notation

	Information enclosed in brackets [ ] in descriptions of operations indicates the name of the slider, button, or terminal.
	This symbol shows the location of the button to be operated, and the number in this symbol indicates the order of operation. The value in this symbol corresponds to the number describing the operating instructions.
	The pointer finger symbol indicates key operation, and the value in this symbol corresponds to the number assigned to the corresponding operation.
	Indicates a note for the operation.
	Indicates explanations of terms, and explanations when names and displays differ.
	Indicates reference pages.

## About cleaning

- Disconnect the power cable plug before cleaning.
- Refrain from using chemicals such as alcohol, benzene, thinner, or chlorine bleach, as they may cause discoloration or deterioration of parts such as the keyboard, exterior, or panels.
- Please note that repeated rubbing may cause discoloration or deterioration depending on the material of the cloth used.
- If the surface of the pedals becomes dirty, wipe them clean with a dry dishwashing sponge. If they are gold pedals, wiping them with a cloth may make them appear cloudy.
- If the pedals become dirty, do not use rust-removing polish or files.

# Table of Contents

## Important Information

Important Safety Instructions .....	2
Introduction .....	6
Table of Contents .....	7

## Preparation

Part Names and Functions .....	8
Key Cover and Music Rest .....	10
Pedals .....	11
Power .....	12
Volume and Headphones .....	13
Home screen .....	14

## Basic Operation

Sounds .....	15
Metronome .....	16
Recorder .....	17
Music Menu .....	18
Entering the Music menu mode .....	18
Demo Songs .....	18
Lesson .....	19
Concert Magic .....	20

## Adjustments & Settings

Settings Menu .....	22
Entering the Settings Menu .....	23
Reverb .....	23
Transpose .....	23
Tone Control .....	24
Low Volume Balance .....	24
Dual .....	25
4 Hands .....	26
Tuning .....	26
Touch Curve .....	27
Virtual Technician Smart Mode .....	27
Damper Noise .....	27
Key Volume .....	28
Startup Settings .....	28
Spatial Headphone Sound .....	29
Phones Type .....	29
Bluetooth® .....	30
Bluetooth® Audio Volume .....	30
Auto Display Off .....	31
Auto Power Off .....	31
Factory Reset .....	32

## Appendix

Troubleshooting .....	33
Internal Songs List .....	36
Connecting to Other Devices .....	38
Assembly Instructions .....	40
Information about Adaptor Specifications .....	44
EU Declaration of Conformity Specifications .....	45
Specifications .....	46

# Part Names and Functions

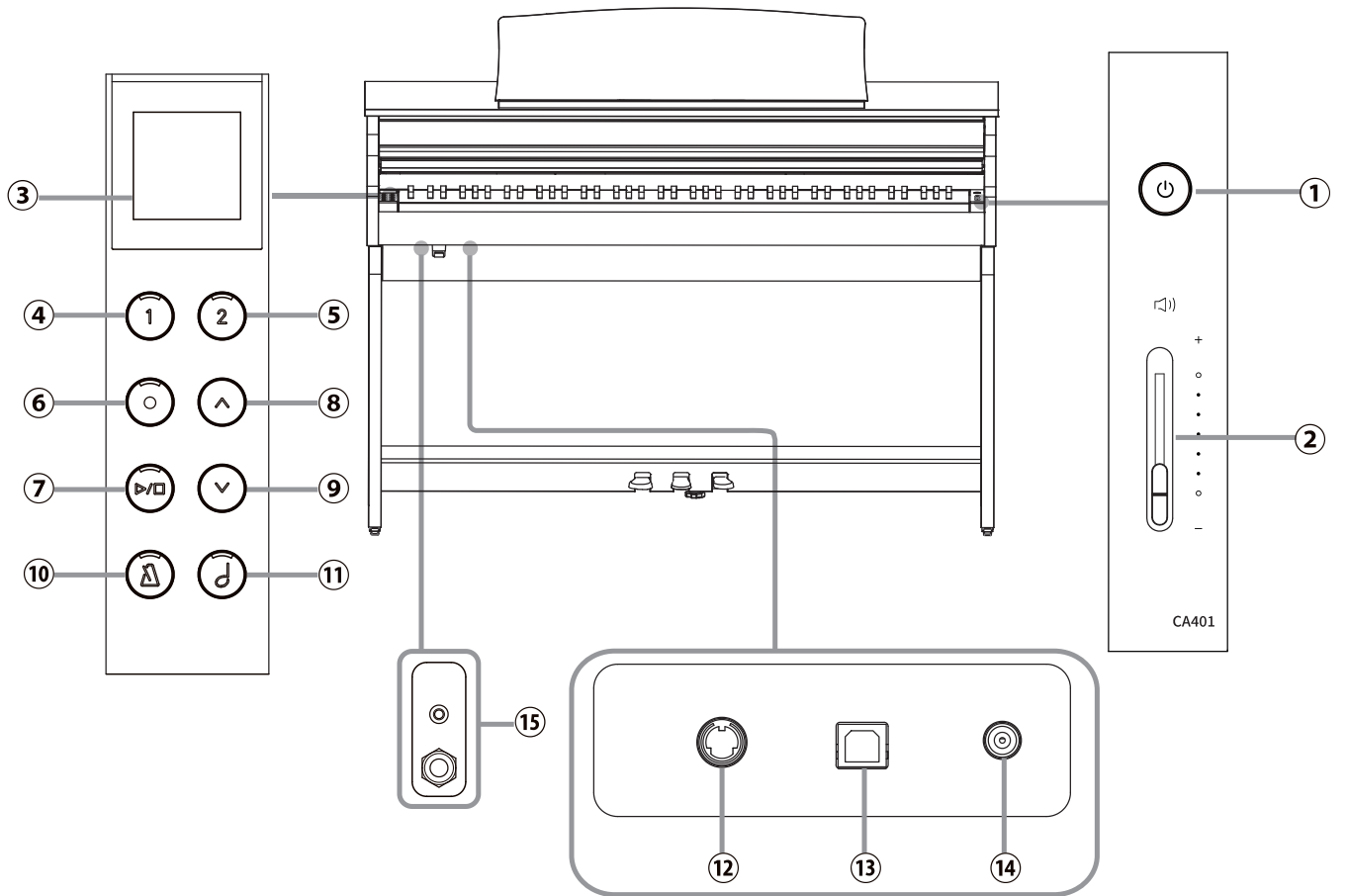

Part Names and Functions



**① [POWER] button**

This button is used to turn the digital piano on/off. Be sure to turn off the instrument after playing.

**② [MASTER VOLUME] slider**

This slider controls the master volume level of the digital piano's built-in speakers or headphones, if connected.

**③ Display**

It shows the function names and setting values.

**CHECK**

A transparent sheet has been applied to the display. Remove the transparent sheet before use.

**④ [1] button**

This button is used to select functions shown on [1].

**⑤ [2] button**

This button is used to select functions shown on [2].

**⑥ [REC] button**

This button is used to record performances.

**⑦ [PLAY/STOP] button**

This button is used to play/stop recorded performances and Internal Songs such as those stored in Lesson.

**⑧ [UP] button**

This button is used to move the menu up or increase the setting values.

**⑨ [DOWN] button**

This button is used to move the menu down or decrease the setting values.

**⑩ [METRONOME] button**

This button is used to turn the metronome function on/off and adjust its tempo, time signature, and volume settings.

**⑪ [SOUND SELECT] button**

This button is used to select sounds.

**⑫ [PEDAL] connector**

This button is used to select sounds.

**⑬ [USB TO HOST] connector**

This port is used to connect the instrument to a computer using a USB "B to A" type cable in order to send and receive MIDI data.

**⑭ [DC IN] connector**

This jack is used to connect the AC adaptor.

**⑮ [PHONES] jacks**

These jacks are used to connect stereo headphones to the digital piano. Mini stereo plug and standard stereo plug connectors are provided for convenience, and both can be used simultaneously, allowing two pairs of headphones to be connected at the same time.

## Opening/Closing the Key Cover

To open the key cover, gently lift it with both hands.

To close the key cover, gently lower it with both hands.

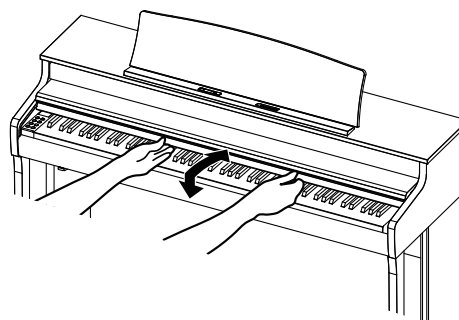

### CHECK

- When opening the key cover, do not place anything on top of it. Items may fall inside the instrument, causing electric shock, shorts, fire, or malfunction.
- Take care that fingers and hands do not get trapped in the space between the key cover and the body of the instrument.

## Music Rest

1. Raise the music rest forward.
2. Fix the metal fittings on the back of the music rest in the desired location on the holder on top of the instrument. (The angle is adjustable in three stages.)

The notated score can be held in place using the score support pins.

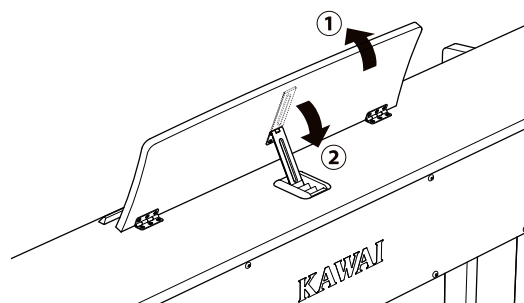

Score Support pins

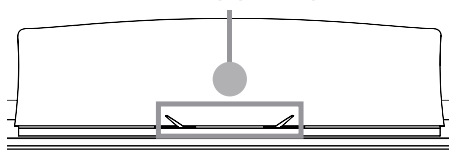

# Pedals

As with a grand piano, this piano features three pedals. These pedals produce the following effects.

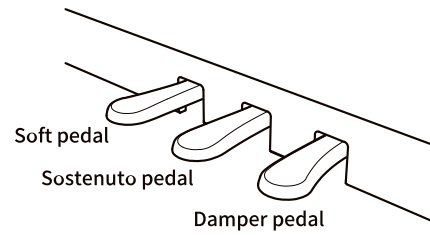

## Damper pedal (right pedal)

Depressing this pedal sustains the sound after one's hands have been lifted from the keyboard – greatly enriching the piano sound, while also assisting smooth “legato” passages. The sustain pedal is capable of responding to half pedaling.

## Sostenuto pedal (centre pedal)

Depressing this pedal after playing the keyboard and before releasing the keys, sustains the sound of only those notes that were played at that moment. Any keys that are subsequently played after the sostenuto pedal is depressed will not be sustained.

## Soft pedal (left pedal)

Depressing this pedal softens the sound, reducing its volume. When the Jazz Organ sound is selected, the soft pedal is also used to alternate the speed of the rotary simulation between “Slow” and “Fast” effect modes.

### CHECK

Depending on the sound, the effect may be difficult to notice.

## Adjustor Bolt

An adjustor bolt is attached to the pedal board. Make sure to turn the adjustor bolt until it makes full contact with the floor. The pedal board may be damaged if the adjustor bolt is not in full contact with the floor or is too strongly pressed against the floor.

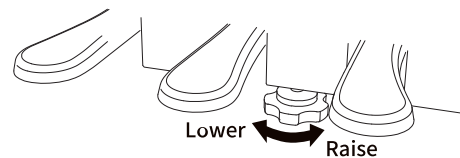

## Grand Feel Pedal System

This digital piano features the Grand Feel Pedal System, which replicates the sustain, soft, and sostenuto pedal weighting of an SK-EX Concert Grand piano.

# Power

## 1. Connecting the AC adaptor to the main body

Plug the supplied AC adaptor into the power cable and insert it into the [DC IN] jack located on the underside of the main body.

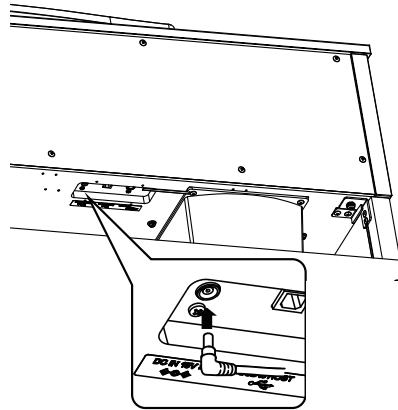

## 2. Connecting the plug into an outlet

Connect the power cable to an AC power outlet.

## 3. Turning on the power

Press the [POWER] button to turn the power on. When the instrument has started up, the LED indicator of the [POWER] button will turn on. To turn the power off, press the [POWER] button again.

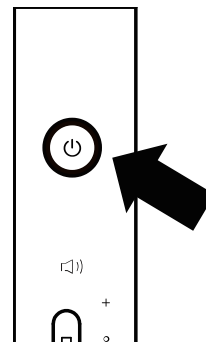

### CHECK

Do not turn off the power until startup is finished. Also, do not unplug the power cable until the display on the screen has disappeared.

# Volume and Headphones

## Adjusting the volume

Use the [MASTER VOLUME] slider located on the right side of the main body to adjust the volume. Move the slider up to increase the volume and down to decrease the volume. Adjust the volume while listening to the sound by striking the keys.

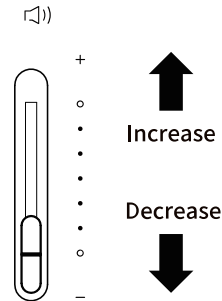

## Using headphones

Connect the headphones to the [PHONES] jacks on the underside of the instrument. When headphones are connected, sound stops coming through the instrument's speakers.

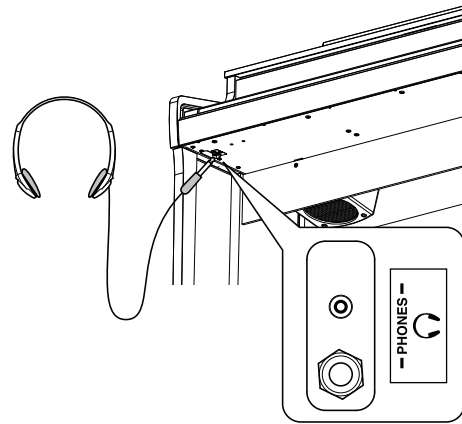

## Using the headphone hook

When not using headphones, the included headphone hook can be used to hold headphones. To use the headphone hook, attach it to the instrument as shown in the illustration.

### CHECK

Do not hang anything other than headphones on the headphone hook. Doing so may result in damage.

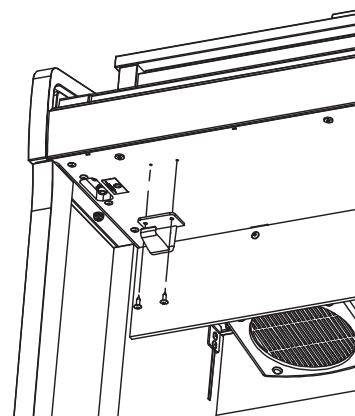

# Home screen

The first screen that appears when the instrument has started up after power-on is called the Home screen. The Home screen is the initial menu of the operation.

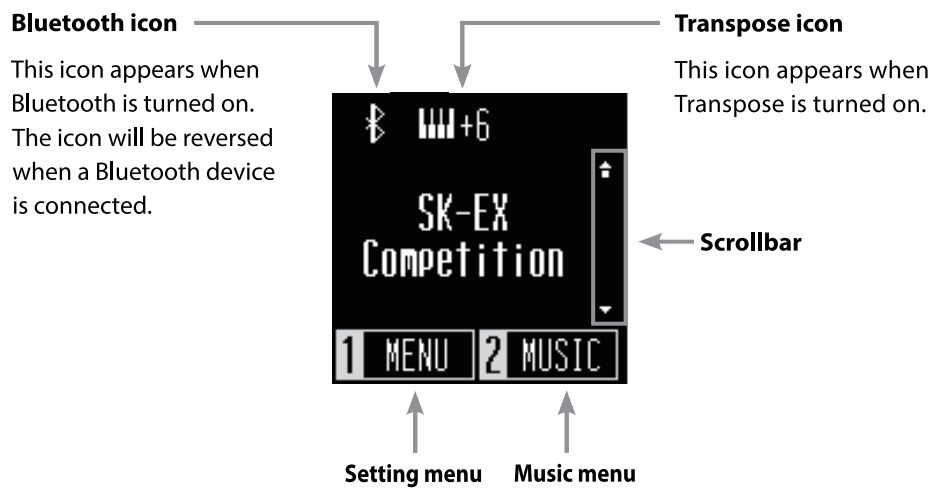

# Sounds

This is used to access the sounds of grand pianos and upright pianos, including SK-EX pianos, as well as a variety of sounds unique to a digital piano.

## Method 1

Press the [UP]/[DOWN] buttons on the Home screen to select sounds.

Press the [UP]/[DOWN] buttons simultaneously to restore the default setting "SK-EX Competition Grand Piano | Concert".

**P.36** Sound / Demo Songs List

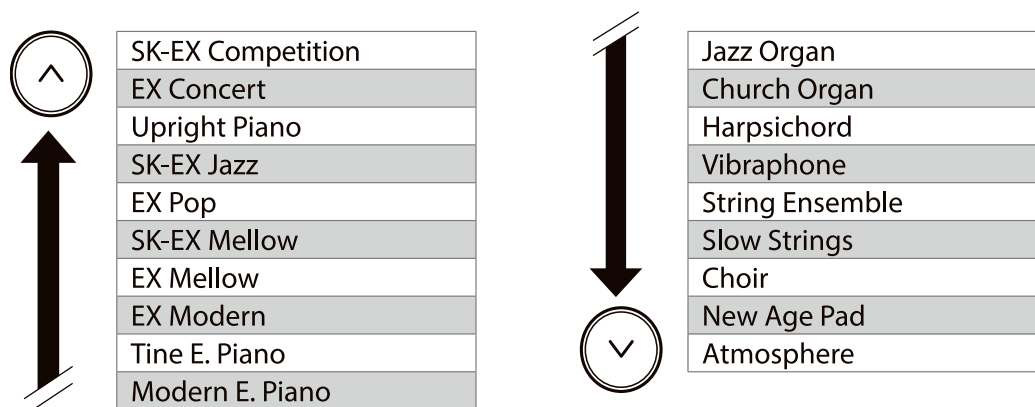

### CHECK

The display shows shortened sound names.

## Method 2

Press the [SOUND SELECT] button on the Home screen to cycle through the sounds in the order as illustrated above and select a sound.

Pressing the [SOUND SELECT] button at "Atmosphere" will move the cursor back to "SK-EX Competition Grand Piano | Concert".

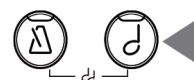

# Metronome

The Metronome function provides a steady beat to aid practicing the piano.

## Turning the Metronome on/off

- Press the [METRONOME] button. The LED for the [METRONOME] button turns on and the metronome sound begins.
- Pressing the [METRONOME] button again will stop the metronome and turn off the LED indicator for the [METRONOME] button.



## Metronome settings

Item	Description
Tempo	The value can be specified in the range from $\downarrow = 10$ to 300. The Tempo Term corresponding to the value is also displayed. The default setting is $\downarrow = 120$ .
Beat	The beat setting is available from the following: 1/4, 2/4, 3/4, 4/4, 5/4, 3/8, 6/8. When the setting 1/4 is selected, it produces only the click sounds without an accent beat. The default setting is 1/4.
Volume	The metronome volume can be specified in the range from 1 to 10. The default setting is 5.

## Setting the Metronome

1. Press the [METRONOME] button.
2. Press the [UP]/[DOWN] buttons to select the setting menu.
3. Press the [1] button to enter the setting menu.
4. Press the [UP]/[DOWN] buttons to set the value.

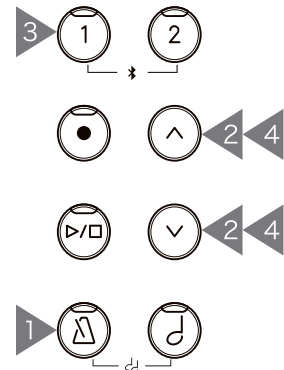

- Pressing the [UP]/[DOWN] buttons simultaneously will restore the default setting.
- Pressing the [2] button will open the Metronome screen again.
- Pressing the [2] button again will restore the Home screen.



# Recorder

This instrument allows songs to be recorded and played back.

## Recording a song

1. Press the [REC] button to enter the Recorder screen.  
The LED indicator for the [REC] button will start to flash once the Recorder screen opens.
2. Press the [UP]/[DOWN] buttons to select a song.
3. Press the [PLAY/STOP] button to start recording.  
Recording can also be started by pressing a key.  
When the recording starts, the LED indicators for the [REC] button and the [PLAY/STOP] button will turn on.
4. When the recording ends, the LED indicators for the [PLAY/STOP] button and the [REC] button will turn off.

A  $\times$  symbol will appear beside the recored song.

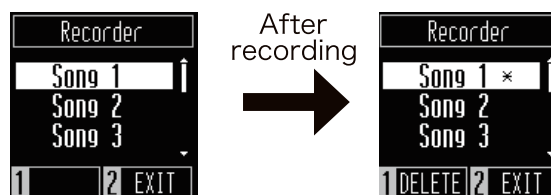
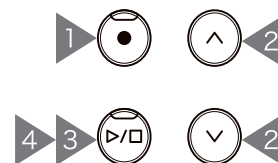

- The performances can be recorded with the Metronome function turned on by pressing the [METRONOME] button.

### CHECK

- When a song is recorded to a song memory containing performance data, the existing performance data will be overwritten by the new performance data.
- The tempo set by the metronome will not be recorded in the recorder data.

## Playing back a recorded song

1. On the Recorder screen, press the [UP]/[DOWN] buttons to select a song to be played back from the list of recorded songs.  
When the LED indicator for the [REC] button is flashing, press the [REC] button.
2. Press the [PLAY/STOP] button to start the playback.
3. Press the [PLAY/STOP] button again to stop the playback.

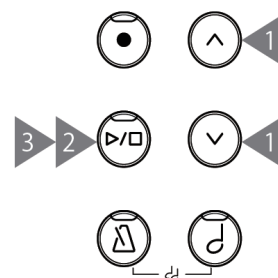

- The tempo can be changed by pressing the [METRONOME] button. The playback speed changes according to the metronome tempo.

**P.16** Metronome settings

## Deleting a recorded song

1. On the Recorder screen, press the [UP]/[DOWN] buttons to select the recorded song to be deleted.
2. Press the [1] button while the LED indicator for the [REC] button is turned off.
3. To delete, press [1]. To cancel, press [2]. After the song has been deleted, the  $\times$  symbol will disappear.

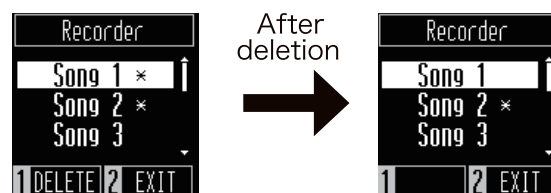

# Music Menu

The built-in songs/pieces included in this instrument can be listened to in a variety of ways that are unique to a digital piano.

Item	Description
Demo Songs	This instrument includes demo songs for each sound.
Lesson	This instrument has a collection of lesson songs stored in memory.
Concert Magic	The Concert Magic function allows complete beginners to enjoy playing the piano by simply tapping the keyboard with a steady rhythm and tempo. Concert Magic songs can also be played back as demo songs.

**P.36** Internal Songs List

## Entering the Music menu mode

1. On the Home screen, press the [2] button to enter the Music menu.
2. Press the [UP]/[DOWN] buttons to select a function to use.
3. Press the [1] button.

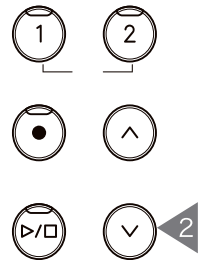

## Demo Songs

### Playing/Stopping demo songs

- On the Demo Songs screen, press the [PLAY/STOP] button to play a demo song.
- Press the [PLAY/STOP] button again to stop the song.

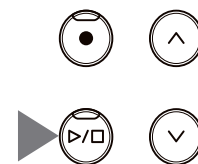

### Changing demo songs

Press the [UP]/[DOWN] or [SOUND SELECT] buttons to change the selected sound and demo song. If the sound is not changed during demo song playback, another demo song will be selected and played at random.

**P.15** Sounds

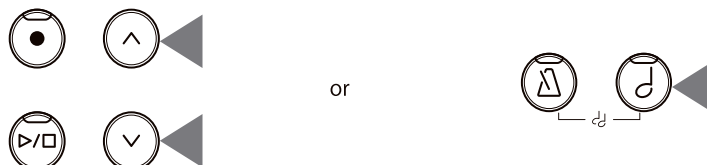

# Lesson

## Lesson song books

US, Canada, Australasia	Rest of the World
Alfred's Basic Piano Library Lesson Book Level 1A	Beyer 106 (Vorschule im Klavierspiel, Opus 101)
Alfred's Basic Piano Library Lesson Book Level 1B	Burgmüller 25 (25 Etudes Faciles, Opus 100)
Beyer 106 (Vorschule im Klavierspiel, Opus 101)	Czerny 30 (Etudes de Mécanisme, Opus 849)
Burgmüller 25 (25 Etudes Faciles, Opus 100)	Chopin Walzer (Chopin waltzes series 1-19)
Czerny 30 (Etudes de Mécanisme, Opus 849)	Alfred's Basic Piano Library Lesson Book Level 1A
Chopin Walzer (Chopin waltzes series 1-19)	Alfred's Basic Piano Library Lesson Book Level 1B

## Playing a lesson song

1. On the Lesson screen, press the [UP]/[DOWN] buttons to select a song book.
2. Press the [1] button to enter the song book selection mode.
3. Press the [UP]/[DOWN] buttons to select a song book.
4. Press the [PLAY/STOP] button to play a song book.

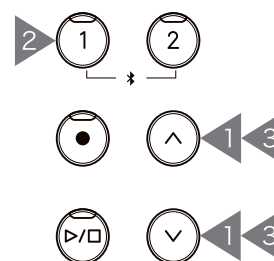

- The sound is set to "SK-EX Competition Grand Piano | Concert".
- Press the [PLAY/STOP] button again to stop the playback of the lesson song. The LED indicator for the [PLAY/STOP] button will turn off.
- After playback has stopped, press and hold the [PLAY/STOP] button to start playback from the beginning.

## Practicing the right-hand (left-hand) parts while playing back the left-hand (right-hand) parts of a lesson song

1. On the Lesson screen, press the [UP]/[DOWN] buttons to select a song book.
2. Press the [1] button to enter the song book selection mode.
3. Press the [1] button to enter the Part Mode screen.
4. Press the [UP]/[DOWN] buttons to select the parts to be played back from "Left & Right," "Left," or "Right".

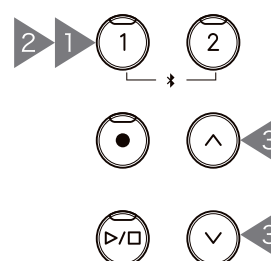

## Changing the tempo

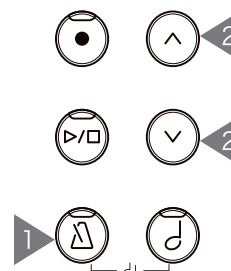

1. While a song is playing, press the [METRONOME] button. The instrument produces beats corresponding to the song.
2. Press the [UP]/[DOWN] buttons to set the tempo.

- Pressing the [UP]/[DOWN] buttons simultaneously will restore the default tempo.



# Concert Magic

## Arrangement types

Type	Description	Example
Easy Beat (EB)	Tap out a constant, steady beat on any key of the keyboard.	'Für Elise' 
Melody Play (MP)	Tap out the rhythm of the melody on any key of the keyboard.	'Twinkle, Twinkle, Little Star' 
Skillful (SK)	Tap out the rhythm of both the melody and the accompaniment notes on any key of the keyboard.	'Waltz of the Flowers' 

## Playing a Concert Magic song

1. On the Concert Magic screen, press the [UP]/[DOWN] buttons to select a song.
2. On the Concert Magic screen, press the [SOUND SELECT] button.
3. Press the [UP]/[DOWN] buttons to select a sound.
4. Keep playing the song by pressing any key.

- The song tempo will be determined by the interval of pressing the keys.
- Pressing the keys gently will produce a soft sound, while pressing heavily will produce a loud sound.

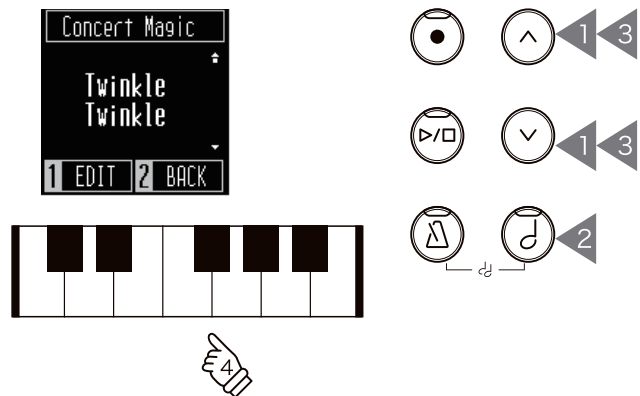

## Listening to a Concert Magic song

On the Concert Magic screen, press the [PLAY/STOP] button to play back a Concert Magic song. Press the [PLAY/STOP] button again to stop the song.

## Setting a Concert Magic song

1. On the Concert Magic screen, press the [1] button.
2. Press the [UP]/[DOWN] buttons to select the setting.
3. Press the [1] button.
4. Press the [UP]/[DOWN] buttons to select the type.

### Demo Mode list

Item	Playback method
All Play	Plays from the first song to the 50th song repeatedly in numerical order.
Repeat Play	Plays the selected songs repeatedly.
Category Play	Plays songs from the selected song's category repeatedly in numerical order.
Random Play	Plays songs selected randomly. The playback starts with 'Twinkle, Twinkle, Little Star.'

### Playing Mode list

Item	Playback method
Normal	Concert Magic songs will be performed according to their arrangement type.
Steady Beat	All Concert Magic songs will be performed by tapping the key with a constant beat.

# Settings Menu

The following settings can be changed in the Settings menu.

Function	Description
Reverb	The Reverb setting adds reverberation to the sound.
Transpose	The Transpose setting allows players to transpose without changing the keyboard key currently used.
Tone Control	The Tone Control setting allows players to optimise the sound quality in order to achieve the best sound quality within the area that the instrument is located.
Low Volume Balance	The Low Volume Balance setting enhances pianissimo touches, allowing the piano to be played more naturally when the [MASTER VOLUME] slider is set to a low level.
Dual	The Dual function allows two sounds to be layered together.
4 Hands	The Four Hands function divides the keyboard into left and right sections, each of which can be played in the same key range.
Tuning	The Tuning setting allows players to adjust the pitch of the instrument.
Touch Curve	The Touch Curve setting allows the relationship between the strength/velocity of playing the keyboard and the volume/tonal character of the sound produced to be adjusted.
Virtual Technician Smart Mode	The Virtual Technician Smart Mode function allows players to make various adjustments on the piano with a single touch of a button.
Damper Noise	The Damper Noise setting adjusts the volume of the noise generated when the damper pedal is depressed and released, or when the damper head touches or moves away from the strings.
Key Volume	The Key Volume setting allows players to adjust the volume of each of the 88 keys.
Startup Settings	The Startup Settings function allows preferred settings to be stored in memory, and automatically recalled as the default settings every time the instrument is turned on.
Spatial Headphone Sound	Spatial Headphone Sound is a feature that enhances the depth and realism of the acoustic piano sound through earphones or headphones.
Phones Type	The Phones Type setting optimises the sound of the instrument when listening through different types of headphones or earphones.
Bluetooth®	This instrument supports wireless connection to smart devices such as smartphones and tablets.
Bluetooth® Audio Volume	This Bluetooth Audio Volume setting allows players to adjust the playback volume of music streamed from smart devices, which is output through the instrument's speakers.
MIDI Settings	MIDI related settings and functions.
Auto Display Off	The Audio Display Off setting can be used to automatically turn off the display when the control panel is not being operated.
Auto Power Off	The Auto Power Off setting can be used to automatically turn off the power after a specified period of inactivity.
Factory Reset	The Factory Reset function restores the instrument back to its factory default configuration.

## Entering the Settings Menu

1. On the Home screen, press the [1] button to enter the Settings Menu.
2. Press the [UP]/[DOWN] buttons to select a function to use.
3. Press the [1] button.
4. Press the [UP]/[DOWN] buttons to set the value and type.
  - Pressing the [UP]/[DOWN] buttons simultaneously will restore the default setting.

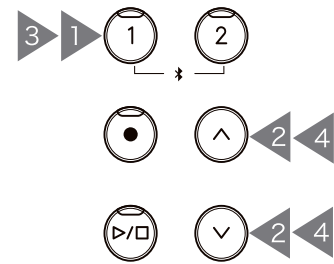

## Reverb

The Reverb setting adds reverberation to the sound.

Type	Effect
Off	Disables the reverb effect.
Room	Simulates the reverb of a small rehearsal room.
Lounge	Simulates the reverb of a piano lounge.
Small Hall	Simulates the reverb of a small hall.
Concert Hall	Simulates the reverb of a concert hall or theatre.
Live Hall	Simulates the reverb of a large hall.
Cathedral	Simulates the reverb of a large cathedral.

## Transpose

The Transpose setting allows players to transpose without changing the keyboard key currently used. This setting may be useful when playing with other instruments tuned for different keys.

The value can be specified in the range from -12 to +12 in semitone steps.

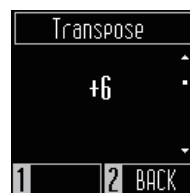

## Tone Control

The Tone Control setting allows players to optimise the sound quality in order to achieve the best sound quality within the area that the instrument is located.

Type	Effect
Flat	Tone control adjustment is not applied.
Brilliance	Adjusts the overall brightness of the sound.
Bass Boost	Emphasises low-range frequencies, creating a deeper sound.
Bass Cut	Reduces low-range frequencies, creating a clearer sound.
Mid Boost	Emphasises mid-range frequencies, creating a harder sound.
Loudness	Emphasises frequencies to retain the digital piano's sound character when playing at low volume levels.
Bright	Emphasises high-range frequencies, creating a brighter sound.
Mellow	Reduces high-range frequencies, creating a softer sound.

### Adjusting the Brilliance value

In the Brilliance setting, the brightness value can be adjusted in the range from -10 to +10.

- On the Tone Control screen, select "Brilliance" and press the [1] button.
- Press the [UP]/[DOWN] buttons to adjust the value.  
<br> Increasing the value will make the sound brighter.

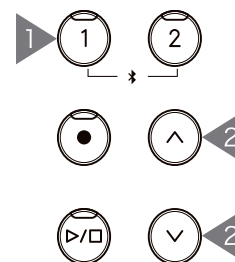

## Low Volume Balance

The Low Volume Balance setting enhances pianissimo touches, allowing the piano to be played more naturally when the [MASTER VOLUME] slider is set to a low level.

The value can be specified in the range from 1 to 5 or set to off. Increasing the value will enhance the sound of pianissimo touches while the volume is reduced.





# Dual

The Dual function allows two sounds to be layered together. Expand the range of musical expression by playing two sounds simultaneously to create a duet of a melody, or by mixing sounds of a similar type to create a thicker sound.

## MEMO

The display shows shortened sound names.

## Selecting a sound for each part

1. On the Dual screen, press the [SOUND SELECT] button and select the part to change its sound.
2. Press the [UP]/[DOWN] buttons to change the sound for the selected part.

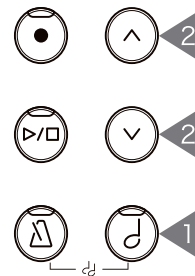

## CHECK

It is also possible to enter the Dual screen by pressing the [SOUND SELECT] and [METRONOME] buttons at the same time.

## Adjusting the volume balance of Dual mode

1. On the Dual screen, press the [1] button to enter the Balance screen.
2. Press the [UP]/[DOWN] buttons to adjust the value.

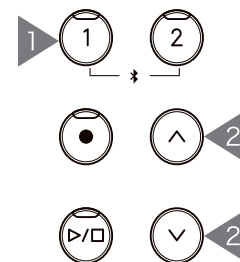

Part 2	Part 1	Description
9	- 1	Balance setting to minimise the volume of Part 1
~	~	
9	- 9	Balance setting to keep the volume of Part 1 and Part 2 at the same level
~	~	
1	- 9	Balance setting to minimise the volume of Part 2

## 4 Hands

The Four Hands function divides the keyboard into left and right sections, each of which can be played in the same key range. In 4 Hands Mode, the sustain (right) pedal and soft (left) pedal act as separate damper pedals for the respective right and left sections of the keyboard.

### CHECK

- In the Four Hands Mode, the Split Point dividing the left and right sections is set to the key F4 (Middle F) and cannot be changed.
- The sostenuto pedal effect applies to the sound from the right section only.

## Selecting a sound

The same sound setting applies to both sections.

### MEMO

The display shows shortened sound names.



## Tuning

The Tuning setting allows players to adjust the pitch of the instrument. This setting may be useful for matching the pitch when playing with an ensemble or playing along with a CD or other audio source.

The pitch can be adjusted in the range from 427.0 to 453.0 Hz in the unit of 0.5 Hz.



## Touch Curve

The Touch Curve setting allows the relationship between the strength/velocity of playing the keyboard and the volume/tonal character of the sound produced to be adjusted. As with an acoustic piano, the digital piano produces a louder sound when the keys are struck with force, and a softer sound when the keys are played gently.

Type	Effect
Light	A very gentle key press will produce a very soft sound.
Normal	Reproduces the standard touch sensitivity of an acoustic piano.
Heavy	Produces a softer sound consistently.
Off	A constant volume is produced regardless of how hard the keys are struck.

## Virtual Technician Smart Mode

The Virtual Technician Smart Mode function allows players to make various adjustments on the piano with a single touch of a button.

Type	Effect
Normal	Default setting for Virtual Technician Smart Mode.
Noiseless	A preset that eliminates the mechanical noises produced when the damper pedal is depressed and keys are released.
Deep Resonance	A preset that emphasises damper and string resonances.
Light Resonance	A preset that reduces damper and string resonances.
Soft	A preset that softens the hammers and increases the touch weight of the keyboard in order to produce a softer tone that is suitable for slow, quiet pieces.
Brilliant	A preset that hardens the hammers in order to produce a brighter tone suitable for modern pieces.
Clean	A preset that hardens the hammers and reduces damper and string resonances.
Full	A preset that emphasises dynamics, with a lightened keyboard touch and powerful damper and string resonances.
Dark	A preset that hardens the hammers and increases the touch weight of the keyboard, in order to produce a dark, gloomy tone.
Rich	A preset that lightenes the touch weight of the keyboard and increases damper and string resonances.
Historical	A preset suitable for romantic, classical music, with a bright, open tone.

## Damper Noise

The Damper Noise setting adjusts the volume of the noise generated when the damper pedal is depressed and released, or when the damper head touches or moves away from the strings.

The value can be adjusted in the range from 0 to 10. Increasing the value will make the noise volume greater.

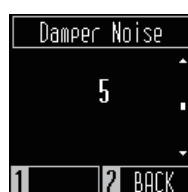

## Key Volume

The Key Volume setting allows players to adjust the volume of each of the 88 keys.

1. On the Key Volume screen, press the [1] button.
2. Press a key to adjust its volume.
3. Press the [UP]/[DOWN] buttons to adjust the volume.

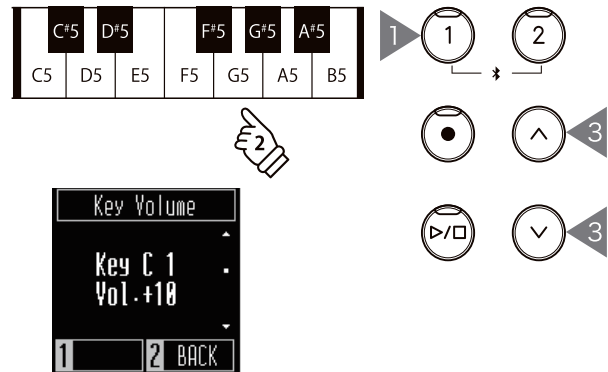

- The adjusted volume value will be saved automatically by exiting the Key Volume function.
- Even after cycling the power, the adjusted Key Volume setting will be re-applied automatically.

## Startup Settings

The Startup Settings function allows preferred settings to be stored in memory, and automatically recalled as the default settings every time the instrument is turned on.

### Settings stored in Startup Settings

- Settings made in the Settings menu
- Metronome tempo, time signature, and volume
- Sounds

On the Startup Settings screen, press the [1] button to store the current settings to memory. When the Startup Settings have been stored, the display will return to the Settings menu.



## Spatial Headphone Sound

Spatial Headphone Sound is a feature that enhances the depth and realism of the acoustic piano sound through earphones or headphones.



### MEMO

The display shows "Spatial HP".

Type	Effect
Off	Disables the Spatial Headphone Sound feature.
Forward	Provides front focuses, somewhat narrow spatial positioning.
Normal	Naturally balanced spatial positioning that is neither forward nor wide.
Wide	Wide, very open spatial positioning.

## Phones Type

The Phones Type setting optimises the sound of the instrument when listening through different types of headphones or earphones.

Type	Effect
Normal	Disables the headphone optimisation.
Open	Optimises the sound for open-type headphones.
Semi-Open	Optimises the sound for semi-open type headphones.
Closed	Optimises the sound for closed-type headphones.
Inner-ear	Optimises the sound for inner-ear type headphones.
Canal	Optimises the sound for canal-type headphones.

## Bluetooth®

This instrument supports wireless connection to smart devices such as smartphones and tablets.

This function can be turned on and off.

Turn on the Bluetooth function of this instrument and enable Bluetooth communications of the smart device application near the instrument.

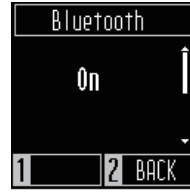

### Bluetooth setting types and connection methods

Type	Description	Connection method
Bluetooth MIDI	Installing a Bluetooth MIDI compatible application on a smart device will allow users to operate the digital piano from the application and send and receive MIDI data.	Tap "CA401 MIDI" on the connection screen of the Bluetooth MIDI compatible application.
Bluetooth Audio	Connect to a smart device to play music and other audio data contained on the smart device.	Tap the "CA401 Audio" option that is displayed when the smart device is turned on. After pairing, it will be connected again automatically every time the power is turned on.

#### CHECK

- Before using an application, be sure to check the latest support status and operating environment information for each application on the Kawai Global website:  
<https://www.kawai-global.com/apps>
- For Bluetooth MIDI and Bluetooth Audio, only one smart device can be connected to each application at the same time.
- Since the digital piano cannot transmit using Bluetooth Audio, speakers and headphones cannot be connected via Bluetooth.

## Bluetooth® Audio Volume

This Bluetooth Audio Volume setting allows players to adjust the playback volume of music streamed from smart devices, which is output through the instrument's speakers. This setting provides an additional method to adjust the audio playback volume, after using the smart device's volume control and the instrument's [MASTER VOLUME] slider.

#### MEMO

The display shows "Bluetooth Vol".

The value can be adjusted in the range from -15 to +15.



## Auto Display Off

The Auto Display Off setting can be used to automatically turn off the display when the control panel is not being operated.

The Auto Display Off setting can be set to 15 seconds, 5 minutes, or 30 minutes. After the display has turned off, pressing any of the control buttons will turn on the display again.



### MEMO

The setting is displayed as "sec." and "min." on the screen.

## Auto Power Off

The Auto Power Off setting can be used to automatically turn off the power after a specified period of inactivity.

The Auto Power Off setting can be set to 15 minutes, 60 minutes, 120 minutes or Off.



### MEMO

The setting is displayed as "min." on the screen.

# Factory Reset

---

The Factory Reset function restores the instrument back to its factory default configuration.

## Initialised settings

- Recorder songs stored in internal memory
- Settings stored using the Startup Settings function.
- Auto Power Off setting
- Key Volume setting

On the Factory Reset screen, press the [1] button to execute Factory Reset, or press the [2] button to cancel. When the Factory Reset is complete, the display will return to the Settings menu.





# Troubleshooting

## Power

---

### The instrument does not turn on.

---

Check that the power cable is correctly connected on both the outlet side and the instrument side. It may be connected on one end, and disconnected on the other. Try disconnecting and then reconnecting the power cable.

P.12

#### 1. Connecting the AC adaptor to the main body

### The power suddenly turns off, or turns off after a period of inactivity

---

Check that the "Auto Power Off" function is not enabled.

### The screen suddenly turns off

---

If the time for the display to turn off has been set in "Auto Display Off", the display will automatically turn off when the set time has elapsed. Tap the display to turn it on again.

## Sound

---

This digital piano attempts to reproduce the rich variety of tones created by an acoustic grand piano as accurately as possible. This includes various resonances, noises, and other subtle characteristics that contribute to the overall piano playing experience. While these additional tones are intended to enhance the realism of the instrument, it is possible to adjust the piano sound to match the player's personal preference, as explained below.

### No sound is produced

---

- Check that the volume is not set to the lowest position.
- Check that a pair of headphones (or a headphone adaptor plug) is not connected to the PHONES jacks.
- Check that Local Control is enabled in the MIDI Settings menu.

P.13

#### Volume and Headphones

## The sound distorts when performing certain pieces or in certain registers

If the volume is increased, the sound may be distorted when performing certain pieces. In this case, turn down the volume before playing the instrument.

## The volume differs depending on the key pressed

Adjust the volume of keys as needed using the Key Volume setting.

P.28

Key Volume

## The sustain pedal is not depressed but the sound in the high end is sustained

This is not abnormal. The keys in the higher register of the keyboard (illustrated below) do not have dampers for stopping the sound. Since this instrument faithfully reproduces that characteristic, the sound from the keyboard is sustained without stepping on the sustain pedal.

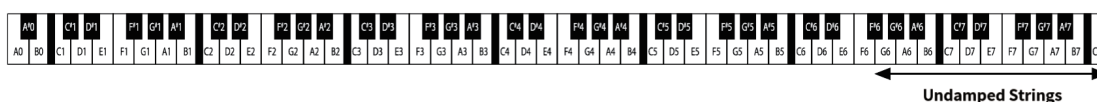

## Pedals

### The pedals make a noise when they are depressed

When the sustain pedal is depressed, you will hear the sound of the strings that occurs when the damper is released even if the keyboard is not being played. This is not a malfunction.

### The pedals are ineffective

Check that the pedal cable is correctly connected to the instrument. Even if it is connected, disconnect the pedal cable and then securely reconnect it.

### When depressing a pedal, the pedal board flexes and is not firm

Check that the pedal support bolt is fully extended.

P.11

Pedals

# Connectivity

---



Bluetooth®

## **The instrument cannot connect to the smart device/app via Bluetooth**

---

- Check that the instrument's Bluetooth function is turned on.
- Bluetooth MIDI should be connected from the settings in the app, not from the Bluetooth settings of the smart device.

## **Cannot connect to a connected smart device**

---

If the connection is immediately disconnected, turn the Bluetooth settings off and then on again, and retry the connection.

## **The name of the instrument does not appear on the smart device**

---

The instrument may be connected to another device. Use "Bluetooth Audio Pairing" to cancel pairing on the instrument.

## **The performance data for the instrument's built-in music cannot be transferred**

---

Performance data for built-in music cannot be output from Bluetooth MIDI.

# Internal Songs List

## Sound / Demo Songs List

Sound Name	Song Title / Composer
SK-EX Competition Grand Piano   Concert	La Campanella / Liszt
EX Concert Grand Piano   Concert	Hungarian Rhapsodies No.6 / Liszt
Upright Piano   Classic	Alpenglühén Op.193 / Oesten
SK-EX Competition Grand Piano   Jazz	Original / Kawai
EX Concert Grand Piano   Pop	Original / Kawai
SK-EX Competition Grand Piano   Mellow	Sonata No.30 Op.109 / Beethoven
EX Concert Grand Piano   Mellow	La Fille aux Cheveux de lin / Debussy
EX Concert Grand Piano   Modern	Original / Kawai
Tine Electric Piano	Original / Kawai
Modern Electric Piano	Original / Kawai
Jazz Organ	Original / Kawai
Church Organ	Chorale Prelude "Wachet auf, ruft uns die Stimme" / Bach
Harpsichord	French Suite No.6 / Bach
Vibraphone	Original / Kawai
String Ensemble	Le quattro stagioni: la "Primavera" / Vivaldi
Slow Strings	Original / Kawai
Choir	Londonderry Air / Irish folk song
New Age Pad	Original / Kawai
Atmosphere	Original / Kawai

# Concert Magic Songs List

## Children's Songs

Song Name	Composer
Twinkle, Twinkle, Little Star	French folk song
I'm A Little Teapot	Traditional
Mary Had A Little Lamb	American folk song
London Bridge	Traditional
Row, Row, Row Your Boat	American folk song
Frère Jacques	French folk song
Old MacDonald Had A Farm	American folk song

## Christmas Songs

Song Name	Composer
Hark The Herald Angels Sing	Mendelssohn
Jingle Bells	Traditional
Deck The Halls	Welsh Air
O Come All Ye Faithful	J.Reading
Joy To The World	Traditional
Silent Night	Traditional
We Wish You A Merry Christmas	British folk song

## American Classics

Song Name	Composer
Battle Hymn Of The Republic	Traditional
Yankee Doodle	American folk song
Londonderry Air	Irish folk song
Clementine	American folk song
Auld Lang Syne	Scottish folk song
Oh Susanna	S.C.Foster
The Camptown Races	S.C.Foster

## American Classics

Song Name	Composer
When The Saints Go Marching In	American folk song
The Entertainer	S.Joplin

## Classical Selections

Song Name	Composer
William Tell Overture	Rossini
Andante from Symphony No.94	Haydn
Für Elise	Beethoven
Clair De Lune	Debussy
Skater's Waltz	E.Waldteufel
Blue Danube Waltz	Strauss
Gavotte	Gossec
Waltz Of The Flowers	Tchaikovsky

## Special Occasions

Song Name	Composer
Bridal Chorus	Wagner
Wedding March	Mendelssohn
Pomp And Circumstance	Elgar

## International Songs

Song Name	Composer
When Irish Eyes Are Smiling	E.R.Ball
Chiapanecas	Mexican folk song
Santa Lucia	Naplish folk song
Funiculi Funiculà	L.Denza
Romance De L'amour	Spanish folk song
My Wild Irish Rose	Chauncy Alcote

# Connecting to Other Devices

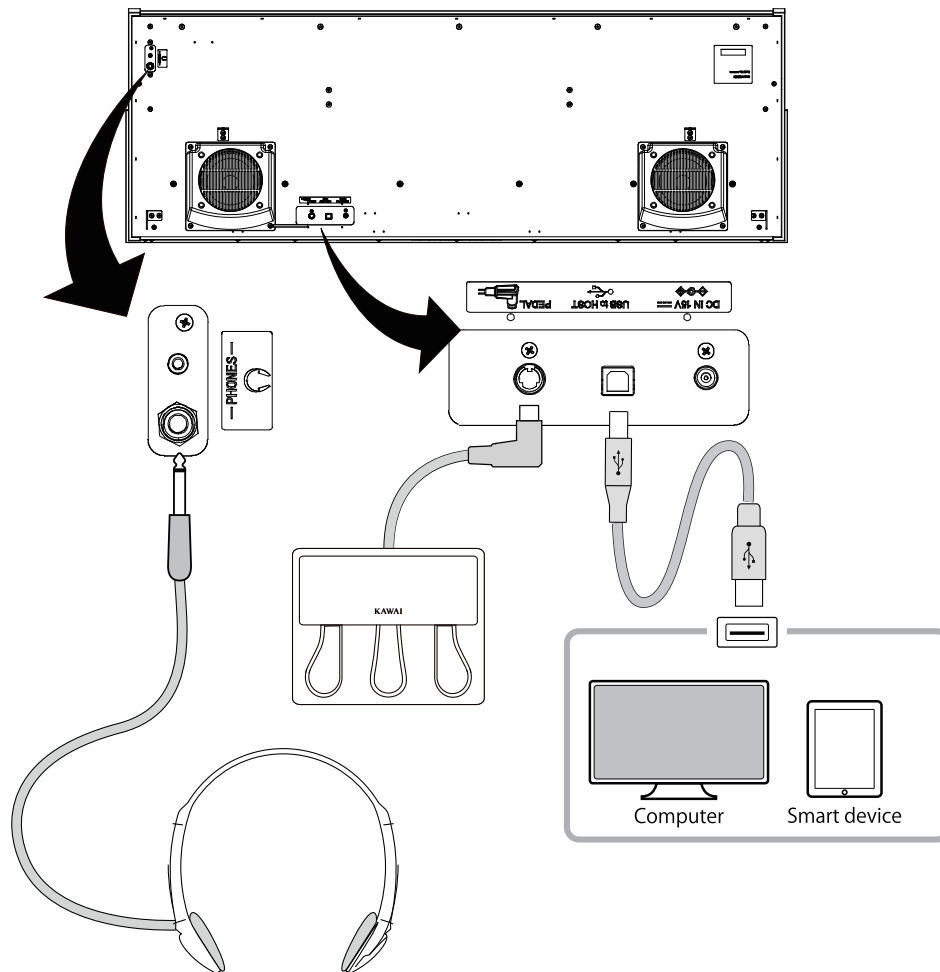

## ① PHONES (Headphones jacks)

These jacks are used to connect headphones. Up to two sets can be connected.

## ② PEDAL (Pedal connector)

This connector is used to plug the pedal cable attached to the pedal unit.

## ③ USB to HOST

This port is used connect the instrument to a computer or smart device using a standard USB cable. The instrument is recognised as a MIDI device that will send and receive MIDI messages. Use the appropriate cable for the device to be connected.

### CHECK

Before connecting the instrument to other devices, make sure to turn off the power of this instrument.

## USB drivers

---

In order to exchange data between this digital piano and a computer via USB connection, the software (USB-MIDI driver) for the digital piano to function properly must be installed in the computer. On most modern operating systems, this driver software will be installed automatically, and additional drivers will not be required. The USB-MIDI driver to use is different depending on the computer's operating system. For more information, please refer to the following page of the Kawai Global website: <https://www.kawai-global.com/usb>

## Smart devices

---

This product supports connection to smart devices and allows players to use applications designed for the instrument. Before using this feature, please check the latest information on the supported applications and operating environment, which is available from the Kawai Global website: <https://www.kawai-global.com/usb>

## Notes regarding USB TO HOST

---

- If Bluetooth MIDI and USB are connected simultaneously, Bluetooth MIDI will be given priority.
- Ensure that the digital piano is turned OFF before attempting to connect the digital piano to a computer using a USB cable.
- When the digital piano is connected to a computer by a USB connection, there may be a short delay before communication begins.
- If the digital piano is connected to a computer via a USB hub and operations become unreliable/unstable, connect the USB cable directly to one of the computer's USB ports.
- Disconnecting the USB cable suddenly, or turning the digital piano on/off during operation may cause instability for digital piano or computer operations in the following situations:
  - while installing the driver
  - while starting up the computer
  - while MIDI applications are performing tasks
  - while communicating with a computer
  - while the computer is in energy saver mode
- If there are any further problems experienced with USB MIDI communication while the instrument is connected, please consult your computer's user's manual and double-check all connections and relevant MIDI settings in the computer's operating system.

## Notes regarding Bluetooth®

---

- A variety of devices operate on the 2.4GHz band used by the Bluetooth function. In some situations, the communication speed or communication distance may decrease, or communication may be disconnected due to the influence of other devices.
- This digital piano is always on standby for Bluetooth connection. If there are multiple Bluetooth compatible devices, be careful not to connect to a device other than the one you want to connect to this digital piano.
- MIDI: Complies with Bluetooth (v5.0)/MIDI over Bluetooth Low Energy
- AUDIO: Bluetooth (supports v5.1 A2DP)

# Assembly Instructions

## ⚠ CAUTION

Please ensure that two or more people work on assembling the digital piano. When moving the digital piano, lift it horizontally and be careful not to pinch your hands or fingers or drop it on your feet.

## Included parts

Before attempting to assemble the digital piano, confirm that all of the parts are included. A Phillips-head screwdriver (not included) will also be required to assemble the instrument.

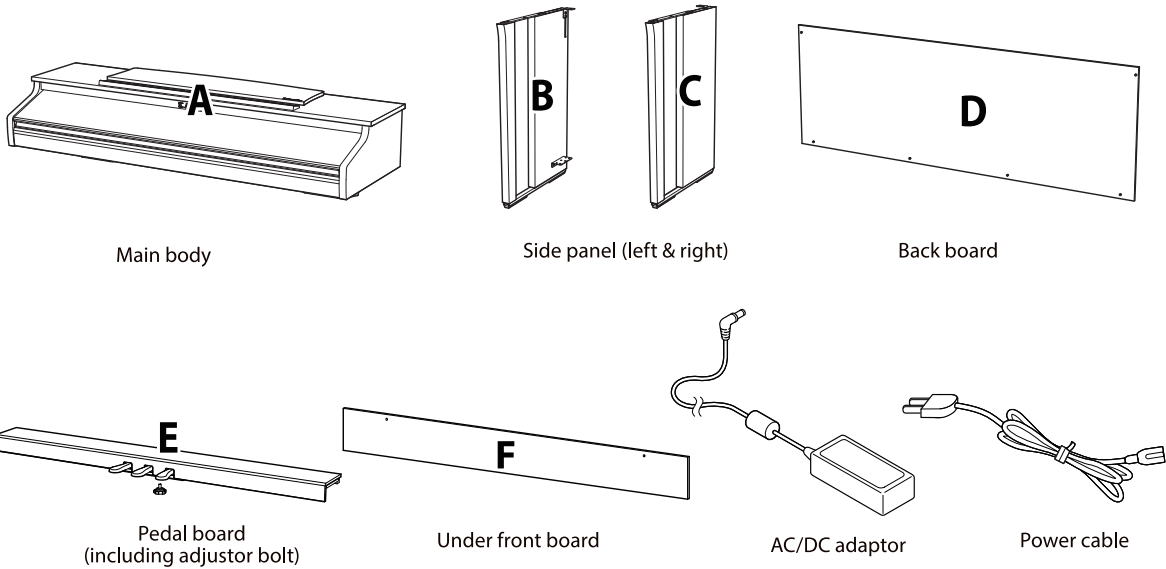

### Screw set

- a** Screw (with flat washer and spring washer) x 4



- b** Flat headed screw (12 mm) x 2



- c** Tapping screw (long, black, 4 x 30 mm) x 4 \*



- d** Tapping screw (short, black, 4 x 20 mm) x 4 \*

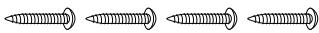

- e** Tapping screw (silver, 4 x 16 mm) x 4 \*\*

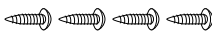

\* For Satin White finished instruments, black screws will be replaced with silver screws.

\*\* The **e** tapping screws are provided in a separate bag.

### Headphone hook set

Headphone hook



Mounting screw x 2  
(4 x 14 mm)





## 1. Attaching the side panels (B and C) to the pedal board (E)

- ① Unfasten and extend the pedal connection cable attached to the bottom of the pedal board (E).
- ② Attach the side panels (B and C) to the pedal board (E) using the temporary mounting screws located on either end of the pedal board.
- ③ Ensure that the side panels (B and C) make close contact with the pedal board (E) so that there are no gaps between the parts, and tighten the temporary mounting screws.
- ④ Insert the four short silver tapping screws **d** into the remaining screw holes as shown, and securely fasten the pedal board to the left and right side panels.

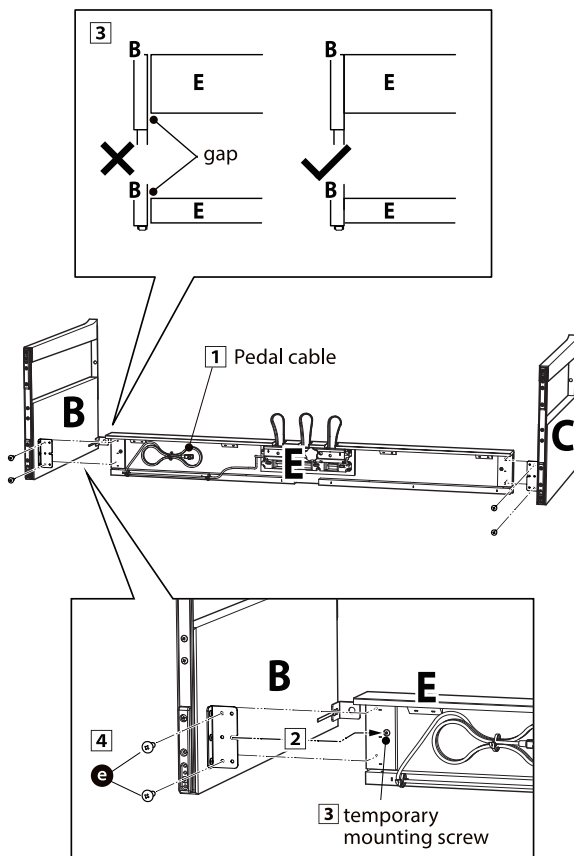

## 2. Attaching the back board (D)

- ① Stand the assembled structure of the pedal board (E) and side panels (B and C) upright (vertically) on the floor as shown in the illustration below.  
At this time, ensure that there are no parts or sheet music on the floor, and that the adjustor bolt is attached to the pedal board.
- ② Loosely attach the back board (D) to the left and right side panels (B and C) using the four long black tapping screws **b**.
- ③ Secure the back board (D) to the pedal board (E) using the four short black tapping screws **c**.
- ④ Tighten the loosely fastened long black tapping screws **b** so that the left and right side panels (B and C) and the back board (D) are aligned and in complete contact with no spaces.

### CHECK

Depending on the colour of the instrument, black screws may be replaced with silver screws.

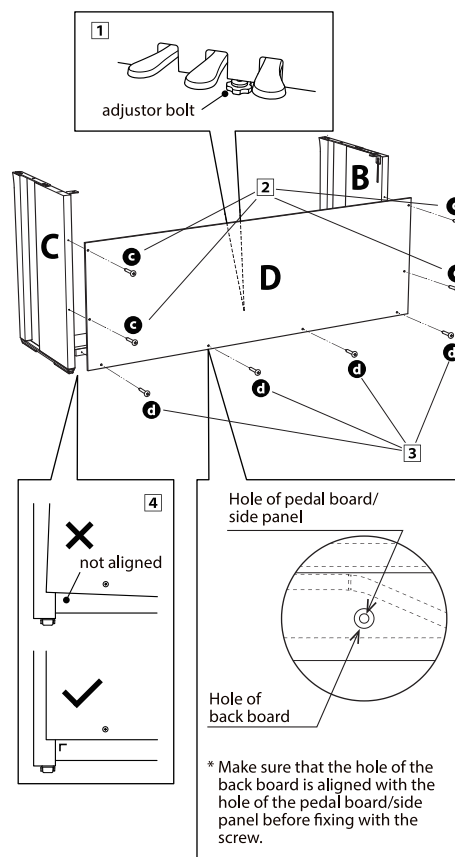

### 3. Mounting the main body (A) onto the stand

① Lift the main body (A) and carefully place it onto the stand.

Position the main body (A) towards the front of the stand, so that the metal fitting holes are visible when viewed from above.

② Secure the side panels (C) in place. While supporting the main body (A) with one hand so that it does not tip and fall, gently slide the main body (A) backwards until the hooks on the main body (A) engage with the metal fittings on the side panels (B and C) and lock into place.

#### ⚠ CAUTION

When lifting the main body (A) onto the stand, be careful not to catch/trap hands and fingers.

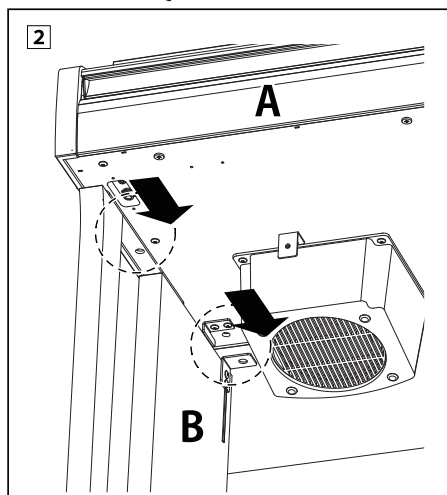
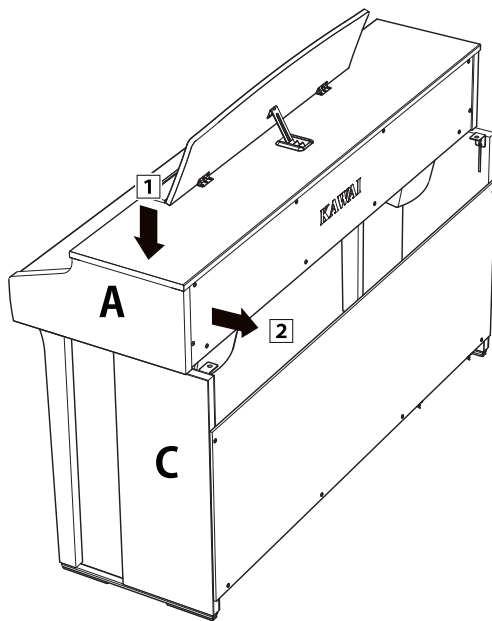

### 4. Fastening the main body (A) to the stand

① Loosely fasten the main body (A) to the stand using four screws (with washer) **a**.

② Loosely tighten the screws **a**, and move the main body (A) into position so that the four screws can be inserted straight. Then, adjust the main body (A) so that the overhang of the main body (A) is even on the left and right when viewed from the front.

③ Tighten the loosely fastened screws **a** until the spring washer is compressed.

#### ⚠ CAUTION

Tighten all screws securely to ensure that the main body (A) is firmly attached to the stand. It is extremely dangerous if the main body (A) falls from the stand.

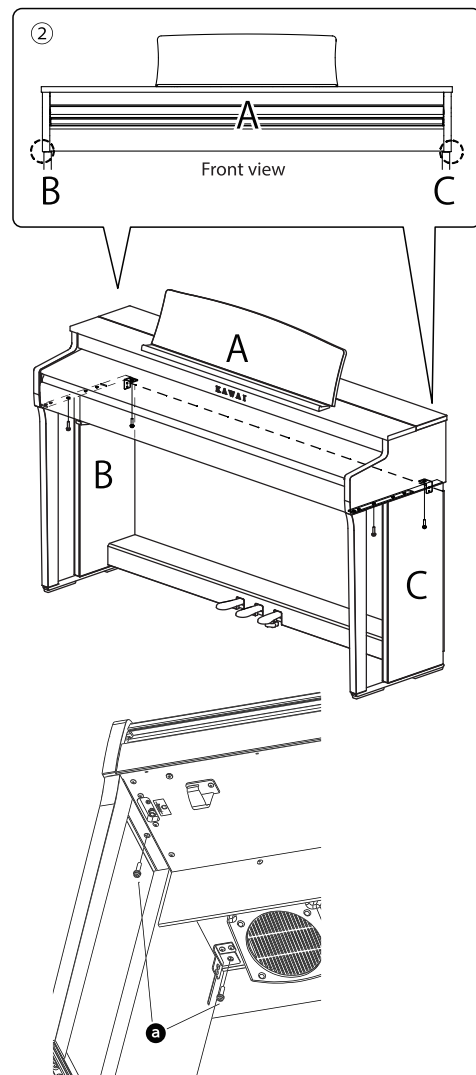

## 5. Connecting the cables

- ① Pass the pedal connection cable coming out of the pedal board (E) through the aperture of the back board (D) to the back of the instrument, and connect it to the PEDAL terminal on the bottom of the main body (A).
- ② Connect the power cable into the [AC INLET] terminal.
- ③ Use the binders on the side boards (B) to fix the cables in place.

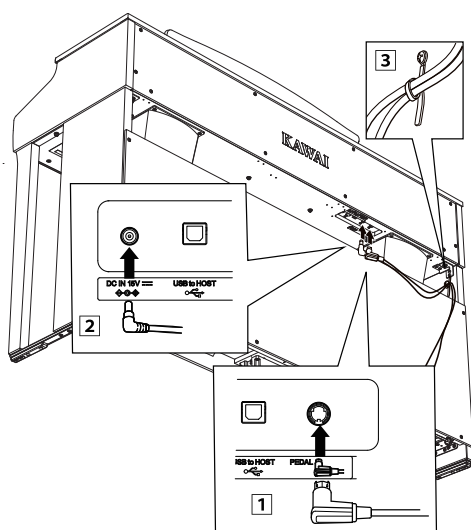

### ⚠ CAUTION

When inserting the plug at the end of the pedal cable into the jack on the bottom of the main body of the digital piano, be sure to align the pins with the position of the hole in the jack, and then insert the plug straight into the jack as far as it will go. If the plug is forcibly inserted in the improper alignment, the pins may bend or break.

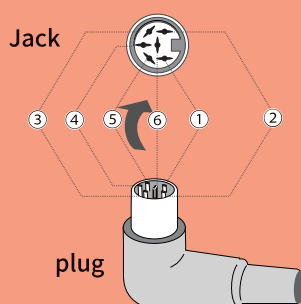

## 6. Attaching the front under board (F)

Attach the front under board (F) to the metal brackets located underneath the main body using the two flat headed screws **6**.

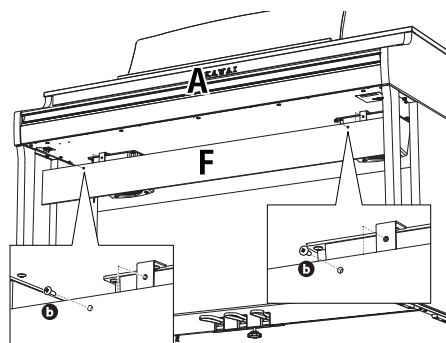

## 7. Attaching the headphone hook

Attach the headphone hook to the underside of the main body using the two installation screws provided as shown in the illustration below.

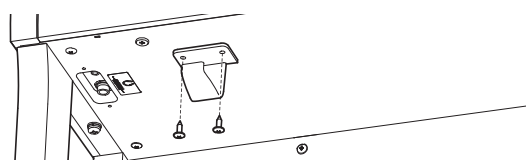

## 8. Adjusting the pedal support bolt

Be sure to turn the pedal support bolt on the back of the pedal base (E) anti-clockwise to extend the bolt until it makes contact with the floor and supports the pedals firmly. Depending on the material and condition of the floor, there may be a noise caused by friction with the floor when the pedal is depressed. If this happens, place felt or carpet between the pedal support bolt and the floor.

### ⚠ CAUTION

If the instrument is used with the pedal support bolt floating off the floor or pressed strongly against the floor, the pedal board may be damaged. When moving the instrument, lift the instrument off the floor and do not drag it.

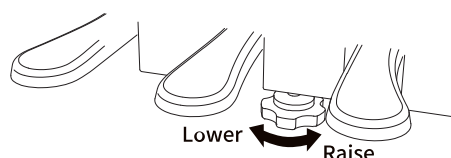

## Information about Adaptor Specifications

This adaptor specification table conforms to the requirements of EU Commission Regulation (EU) 2019/1782.

	Adaptor Type			
	PS-129	PS-154	PS-241	PS-242
<b>Manufacturer's trademark</b>	<b>KAWAI</b>	<b>KAWAI</b>	<b>KAWAI</b>	<b>KAWAI</b>
<b>Model identifier</b>	<b>PS-129</b>	<b>PS-154</b>	<b>PS-241</b>	<b>PS-242</b>
<b>Input voltage</b>	<b>230 V</b>	<b>230 V</b>	<b>230 V</b>	<b>230 V</b>
<b>Input AC frequency</b>	<b>50 Hz</b>	<b>50 Hz</b>	<b>50 Hz</b>	<b>50 Hz</b>
<b>Output voltage</b>	<b>12.0 V</b>	<b>15.0 V</b>	<b>24.0 V</b>	<b>24.0 V</b>
<b>Output current</b>	<b>2.0 A</b>	<b>4.0 A</b>	<b>6.2 A</b>	<b>5.0 A</b>
<b>Output power</b>	<b>24.0 W</b>	<b>60.0 W</b>	<b>150.0 W</b>	<b>120.0 W</b>
<b>Average active efficiency</b>	<b>90.38%</b>	<b>90.17%</b>	<b>90.41%</b>	<b>91.55%</b>
<b>Efficiency at low load (10%)</b>	<b>85.71%</b>	<b>85.13%</b>	<b>78.62%</b>	<b>88.84%</b>
<b>No-load power consumption</b>	<b>0.061 W</b>	<b>0.200W</b>	<b>0.135 W</b>	<b>0.020 W</b>

# EU Declaration of Conformity

## EU Declaration of Conformity

BG	<b>ОПРОСТЕНА ЕС ДЕКЛАРАЦИЯ ЗА СЪОТВЕТСТВИЕ</b>
Bulgarian	С настоящото Kawai Europa GmbH декларира, че този тип радиосъоръжение [ CN201 ] е в съответствие с Директива 2014/53/EC. Цялостният текст на ЕС декларацията за съответствие може да се намери на следния интернет адрес:
ES	<b>DECLARACIÓN UE DE CONFORMIDAD SIMPLIFICADA</b>
Spanish	Por la presente, Kawai Europa GmbH declara que el tipo de equipo radioeléctrico [ CN201 ] es conforme con la Directiva 2014/53/UE. El texto completo de la declaración UE de conformidad está disponible en la dirección Internet siguiente:
CS	<b>ZJEDNODUŠENÉ EU PROHLÁŠENÍ O SHODĚ</b>
Czech	Tímto Kawai Europa GmbH prohlašuje, že typ rádiového zařízení [ CN201 ] je v souladu se směrnicí 2014/53/EU. Úplně znění EU prohlášení o shodě je k dispozici na této internetové adrese:
DA	<b>FORENKLET EU-OVERENSSTEMMELSESERKLÆRING</b>
Danish	Hermed erklærer Kawai Europa GmbH, at radioudstyrtypen [ CN201 ] er i overensstemmelse med direktiv 2014/53/EU. EU-overensstemmelseerklæringens fulde tekst kan findes på følgende internetadresse:
DE	<b>VEREINFACHTE EU-KONFORMITÄTSEKTLÄRUNG</b>
German	Hiermit erklärt Kawai Europa GmbH, dass der Funkanlagentyp [ CN201 ] der Richtlinie 2014/53/EU entspricht. Der vollständige Text der EU-Konformitätserklärung ist unter der folgenden Internetadresse verfügbar:
ET	<b>LIHTSUSTATUD ELI VASTAVUSDEKLARATSIOON</b>
Estonian	Käesolevaga deklareerib Kawai Europa GmbH, et käesolev raadioseadme tüüp [ CN201 ] vastab direktiivi 2014/53/EL nõuetele. ELi vastavusdeklaratsiooni täielik tekst on kättesaadav järgmisel internetiaadressil:
EL	<b>ΑΠΛΟΥΣΤΕΥΜΕΝΗ ΔΗΛΩΣΗ ΣΥΜΜΟΡΦΩΣΗΣ ΕΕ</b>
Greek	Με την παρούσα ο/η Kawai Europa GmbH, δηλώνει ότι ο ραδιοεξοπλισμός [ CN201 ] πληροί την οδηγία 2014/53/ΕΕ. Το πλήρες κείμενο της δήλωσης συμμόρφωσης ΕΕ διατίθεται στην ακόλουθη ιστοσελίδα στο διαδίκτυο:
EN	<b>SIMPLIFIED EU DECLARATION OF CONFORMITY</b>
English	Hereby, Kawai Europa GmbH declares that the radio equipment type [ CN201 ] is in compliance with Directive 2014/53/UE. The full text of the EU declaration of conformity is available at the following internet address:
FR	<b>DECLARATION UE DE CONFORMITE SIMPLIFIEE</b>
French	Le soussigné, Kawai Europa GmbH, déclare que l'équipement radioélectrique du type [ CN201 ] est conforme à la directive 2014/53/UE. Le texte complet de la déclaration UE de conformité est disponible à l'adresse internet suivante:
HR	<b>POJEDNOSTAVLJENA EU IZJAVA O SUKLADNOSTI</b>
Croatian	Kawai Europa GmbH ovime izjavljuje da je radijska oprema tipa [ CN201 ] u skladu s Direktivom 2014/53/EU. Cjeloviti tekst EU izjave o sukladnosti dostupan je na sljedećoj internetskoj adresi:
IT	<b>DICHIARAZIONE DI CONFORMITÀ UE SEMPLIFICATA</b>
Italian	Il fabbricante, Kawai Europa GmbH, dichiara che il tipo di apparecchiatura radio [ CN201 ] è conforme alla direttiva 2014/53/UE. Il testo completo della dichiarazione di conformità UE è disponibile al seguente indirizzo Internet:
LV	<b>VIENKĀRŠOTA ES ATBILSTĪBAS DEKLARĀCIJA</b>
Latvian	Ar šo Kawai Europa GmbH deklarē, ka radioiekārta [ CN201 ] atbilst Direktīvai 2014/53/ES. Pilns ES atbilstības deklarācijas teksts ir pieejams šādā interneta vietnē:
LT	<b>SUPAPRASTINTA ES ATITIKTIES DEKLARACIJA</b>
Lithuanian	Aš, Kawai Europa GmbH, patvirtinu, kad radijo įrenginių tipas [ CN201 ] atitinka Direktyvą 2014/53/ES. Visas ES atitikties deklaracijos teksto prieinamas šiuo interneto adresu:
HU	<b>EGYSZERŰSÍTETT EU-MEGFELELŐSÉGI NYILATKOZAT</b>
Hungarian	Kawai Europa GmbH igazolja, hogy a [ CN201 ] típusú rádióberendezés megfelel a 2014/53/EU irányelvnek. Az EU-megfelelőségi nyilatkozat teljes szövege elérhető a következő internetes címen:
MT	<b>DIKJARAZZJONI SSIMPLIFIKATA TA' KONFORMITÀ TAL-UE</b>
Maltese	B'dan, Kawai Europa GmbH, niddikjara li dan it-tip ta' taghmir tar-radju [ CN201 ] huwa konformi mad-Direttiva 2014/53/UE. It-test kollu tad-dikjarazzjoni ta' konformità tal-UE huwa disponibbli f'dan l-indirizz tal-Internet li ġej:
NL	<b>VEREENVOUDIGDE EU-CONFORMITEITSVERKLARING</b>
Dutch	Hierbij verklaar ik, Kawai Europa GmbH, dat het type radioapparatuur [ CN201 ] conform is met Richtlijn 2014/53/EU. De volledige tekst van de EU-conformiteitsverklaring kan worden geraadpleegd op het volgende internetadres:
PL	<b>UPROSZCZONA DEKLARACJA ZGODNOŚCI UE</b>
Polish	Kawai Europa GmbH niniejszym oświadczam, że typ urządzenia radiowego [ CN201 ] jest zgodny z dyrektywą 2014/53/UE. Pełny tekst deklaracji zgodności UE jest dostępny pod następującym adresem internetowym:
PT	<b>DECLARAÇÃO UE DE CONFORMIDADE SIMPLIFICADA</b>
Portuguese	O(a) abaixo assinado(a) Kawai Europa GmbH declara que o presente tipo de equipamento de rádio [ CN201 ] está em conformidade com a Diretiva 2014/53/UE. O texto integral da declaração de conformidade está disponível no seguinte endereço de Internet:
RO	<b>DECLARAȚIA UE DE CONFORMITATE SIMPLIFICATĂ</b>
Romanian	Prin prezenta, Kawai Europa GmbH declară că tipul de echipamente radio [ CN201 ] este în conformitate cu Directiva 2014/53/UE. Textul integral al declarației UE de conformitate este disponibil la următoarea adresă internet:
SK	<b>ZJEDNODUŠENÉ EÚ VYHLÁSENIE O ZHODE</b>
Slovak	Kawai Europa GmbH týmto vyhlasuje, že rádiové zariadenie typu [ CN201 ] je v súlade so smernicou 2014/53/EU. Úplné EÚ vyhlásenie o zhode je k dispozícii na tejto internetovej adrese:
SL	<b>POENOSTAVLJENA IZJAVA EU O SKLADNOSTI</b>
Slovenian	Kawai Europa GmbH potrjuje, da je tip radijske opreme [ CN201 ] skladen z Direktivo 2014/53/EU. Celotno besedilo izjave EU o skladnosti je na voljo na naslednjem spletnem naslovu:
FI	<b>YKSINKERTAISTETTU EU-VAATIMUSTENMUKAISUUSVAKUUTUS</b>
Finnish	Kawai Europa GmbH vakuuttaa, että radiolaitetyyppi [ CN201 ] on direktiivin 2014/53/EU mukainen. EU-vaatimustenmukaisuusvakuutuksen täysimittainen teksti on saatavilla seuraavassa internetosoitteessa:
SV	<b>FÖRENKLAD EU-FÖRSÄKRAN OM ÖVERENSSTÄMMELSE</b>
Swedish	Härmed försäkras Kawai Europa GmbH att denna typ av radioutrustning [ CN201 ] överensstämmer med direktiv 2014/53/EU. Den fullständiga texten till EU-försäkran om överensstämmelse finns på följande webbadress:
<a href="https://www.kawai-global.com/">https://www.kawai-global.com/</a>	

# Specifications

Keyboard	Grand Feel Compact with Let-Off , Triple Sensor, and Counterweights 88 wooden keys with Ivory Touch key surfaces
Display	128 x 128 dots OLED
Polyphony	Max. 192 notes (depending on the selected sound)
Sounds	19 sounds
Metronome	1/4, 2/4, 3/4, 4/4, 5/4, 3/8, 6/8 beat
Internal Recorder	3 song recorder – approximately 10,000 note memory capacity
Built-in Songs/Pieces	338 songs (Demo Songs: 19 songs, Lesson: 279 songs, Concert Magic: 40 songs)
Effect	Reverb (Room, Lounge, Small Hall, Concert Hall, Live Hall, Cathedral)
Headphone Functions	Spatial Headphone Sound, Phones Type
Bluetooth® Functions	MIDI: Bluetooth (Ver. 5.0)/MIDI over Bluetooth Low Energy compliant Audio: Bluetooth (supports Ver. 5.1 A2DP)
Other Functions	Tone Control, Low Volume Balance, Dual, 4 Hands, Tuning, Touch Curve, Virtual Technician Smart Mode, Damper Noise, Key Volume, Startup Settings, Bluetooth®, Bluetooth® Audio Volume, MIDI Settings, Auto Display Off, Auto Power Off, Factory Reset
Pedals	Sustain (with half-pedal support), Soft, Sostenuto
Key Cover	Sliding type
Jacks	Headphones x 2, USB to HOST
Output Power	20 W x 2
Speakers	13 cm x 2 (woofer), 5 cm x 2 (tweeter)
Output Power	AC100~240V, 50/60Hz
Power Consumption	12 W
Dimensions	1360 (W) x 486 (D) x 915 (H) mm (music rest flat)
Weight	57.5 kg

- Specifications are subject to change without notice.
- Availability of Bluetooth function dependent on market location.



# **KAWAI**

---

THE FUTURE OF THE PIANO

