

Here's What You Can Do

Having Fun Playing the Piano

♪ Playing the Different Tones

page 6

This instrument features not only grand piano tones for use in concerts, but also has a wide range of other built-in instrument tones. You can also layer the tones when you play.

♪ Listening to and Practicing with the Built-in Songs

page 6

This piano comes with built-in songs in a variety of genres from classical to jazz, songs for practicing and more. Try using these built-in songs as examples when you practice. A metronome is also available to help develop your sense of rhythm when you're practicing.

♪ Recording Your Performance

page 8

You can record your own keyboard performance, and then play back to check it. Listen back to what you play and use this to help build your playing skills.

Using Bluetooth®

♪ Playing music through the piano's speakers (Bluetooth® Audio)

page 10

You can connect your smartphone or tablet to this instrument and listen to your favorite songs through the piano's speakers. This lets you "play along" with the performances of the musicians you admire.

♪ Using the piano with apps (Bluetooth® MIDI)

page 11

Connect this piano with an app for access to an even greater palette of tones. You can also use this functionality to experience a new world of piano performance by finding new sheet music and by using the practice assist features.

Contents

Quick Operations	2
Before You Play	4
Opening/Closing the Keyboard Cover	4
Connecting Other Devices (Rear)	4
Connecting Other Devices (Bottom)	4
Basic Operations of the RP107	5
Playing the Piano, Listening to Songs and Practicing	6
Selecting a Tone	6
Playing Back a Song	6
Practicing with the Metronome	7
Recording a Performance	8
Recording Your Keyboard Performance	8
Exporting Your Performance to a USB Flash Drive	8
Advanced Features	9
Outputting Sound from Both Headphones and the Built-in Speakers (Speaker Auto Mute)	9
Saving the Settings (Memory Backup)	9
Returning to the Factory Settings (Factory Reset)	9

Connecting the Piano and a Mobile Device via Bluetooth®	10
Here's What You Can Do	10
Play Music Through the Piano's Speakers	10
Using the Piano with an App	11
Troubleshooting	13
USING THE UNIT SAFELY	15
IMPORTANT NOTES	16
Main Specification	17
Internal Song List	18
Index	20

Downloading the app

iOS

Android

Download the app for your smartphone or tablet for use with the piano.

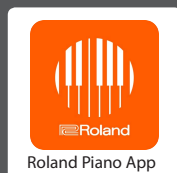

This app lets you view sheet music in digital form, practice songs as if you were playing a game, or keep a record of your practicing.

Before using this unit, carefully read "USING THE UNIT SAFELY" and "IMPORTANT NOTES" (leaflet "USING THE UNIT SAFELY" and Owner's Manual p. 15). After reading, keep the document(s) where it will be available for immediate reference.

Quick Operations

Hold down the  (settings) button and press the keys to switch between the various functions.

Select a tone	1	Press one key to select a single tone that plays with each key press.						
	2	Press two keys at the same time to select two different tones that play together with each key press. This function is called "Dual Play".						
Select a song	2	Select the built-in song category.						
	3	Select either a song on the USB flash drive, or a song recorded in internal memory.						
	4	Select the song to play back. → "Internal Song List" (p. 18)						
Play back or stop a song	5	Play back all of the songs within the category, or just one. Press the same key again to stop playback.						
Specifying the keyboard tone for song playback (SMF play mode)	6	Normally you will use the "Auto-Select" setting.						
		<table border="1"> <thead> <tr> <th>Setting</th> <th>Explanation</th> </tr> </thead> <tbody> <tr> <td>Auto-Select (default)</td> <td>Either "Internal" or "External" is selected automatically depending on the song that you play back.</td> </tr> <tr> <td>Internal</td> <td>The tone for the song that plays back and the tone you use when playing the keyboard are the same. The tone for the song changes when you change the tone on the RP107. We recommend this setting when playing the built-in songs. The damper resonance (*1) effect is applied to the piano tone for the song.</td> </tr> <tr> <td>External</td> <td>A different tone can be used for the song that plays back and for the tone you use when playing the keyboard. The tone for the song doesn't change when you change the tone on the RP107. We recommend this setting when playing back song files from your computer connected via USB. The damper resonance (*1) effect is not applied to the piano tone for the song.</td> </tr> </tbody> </table>	Setting	Explanation	Auto-Select (default)	Either "Internal" or "External" is selected automatically depending on the song that you play back.	Internal	The tone for the song that plays back and the tone you use when playing the keyboard are the same. The tone for the song changes when you change the tone on the RP107. We recommend this setting when playing the built-in songs. The damper resonance (*1) effect is applied to the piano tone for the song.
Setting	Explanation							
Auto-Select (default)	Either "Internal" or "External" is selected automatically depending on the song that you play back.							
Internal	The tone for the song that plays back and the tone you use when playing the keyboard are the same. The tone for the song changes when you change the tone on the RP107. We recommend this setting when playing the built-in songs. The damper resonance (*1) effect is applied to the piano tone for the song.							
External	A different tone can be used for the song that plays back and for the tone you use when playing the keyboard. The tone for the song doesn't change when you change the tone on the RP107. We recommend this setting when playing back song files from your computer connected via USB. The damper resonance (*1) effect is not applied to the piano tone for the song.							
		(*1) This refers to the overall resonance of the acoustic piano when its damper pedal is pressed (the sound of other strings vibrating in sympathy when you press the damper pedal, and the resonance of the entire instrument).						
Bluetooth settings	7	Turn Bluetooth on to connect to the "Roland Piano App" app. (Default value: On) → "Connecting the Piano and a Mobile Device via Bluetooth" (p. 10)						
Start and stop the metronome	8	The metronome switches on/off with each key press.						
Change the metronome's volume	9	1–10 (default value: 5)						
Change the time signature	10	0/4 (*2), 2/2, 3/2, 2/4, 3/4, 4/4, 5/4, 6/4, 7/4, 3/8, 6/8, 8/8, 9/8, 12/8 (default value: 4/4) (*2) Each beat plays with the same sound when the metronome plays.						
Change the tempo	11	10–500 (default: 108)						
Add ambience to the sound (Ambience)	12	The reverberation that is characteristic of a performance in a concert hall can be added to the sound. Higher values produce deeper ambience; lower values produce shallower ambience. 0–10 (default value: 1)						
Make the ambience sound natural when using headphones (Headphones 3D Ambience)	13	You can apply a Headphones 3D Ambience effect that creates the impression that the sound is being heard from the piano itself even when you're using headphones. (Default value: On) * The Headphones 3D Ambience effect applies only to piano sounds; it does not apply to other sounds.						
Adjust the brightness of the sound (Brilliance)	14	You can adjust the brightness of the sound when you play the keyboard or when you play back a song. Higher values produce brighter sounds. -10→+10 (default value: 0)						

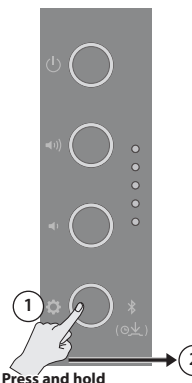

Press and hold 

	1					2				6		5	4	3	7	9	8																									
	A#0	C#1	D#1	F#1	G#1	A#1	C#2	D#2	F#2	G#2	A#2	B2	C#3	D#3	F#3	G#3	A#3	C#4																								
Concert Piano	Ballad Piano	Mellow Piano	Bright Piano	Stage EP	Pop EP	Magical Piano	Harpischord	Celesta	Vibraphone	Pipe Organ	Combo Jz. Organ	SymphonicStr1	Soft Pad	Jazz Scat	Listening	Ensemble	Entertainment	Do Re Mi Lesson	Scales	Hanon	Beyer	Burgmüller	Czerny 100	Auto-Select	Internal	External	Play/stop one song	Play/stop all songs	Go to previous song	Go to first song	Go to next song	USB Memory	Internal Memory (one song only)	On (default value)	Off	-1	5 (default value)	+1	On/off			
A0	B0	C1	D1	E1	F1	G1	A1	B1	C2	D2	E2	F2	G2	A2	B2	C3	D3	E3	F3	G3	A3	B3	C4	D4																		

Before You Play

Opening/Closing the Keyboard Cover

Make sure to use both hands when closing or opening the keyboard cover.

* When opening or closing the keyboard cover, take care not to pinch your fingers between the moving part and the piano unit. In places where small children are present, make sure that an adult provides supervision and guidance.

Opening the Keyboard Cover

Use both hands to lift up the edge of the cover, and push it away from you.

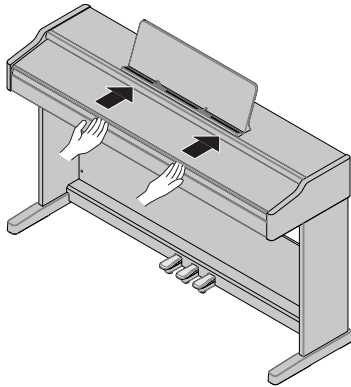

Closing the Keyboard Cover

Hold the cover with both hands and gently pull it towards you.

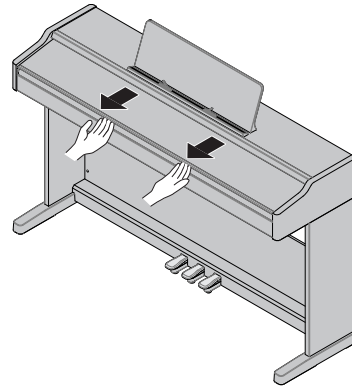

* Do not open the cover with objects (such as paper or metal items) lying on top. This might cause the objects to be pushed inside the piano unit, and you may not be able to retrieve them.

Connecting Other Devices (Rear)

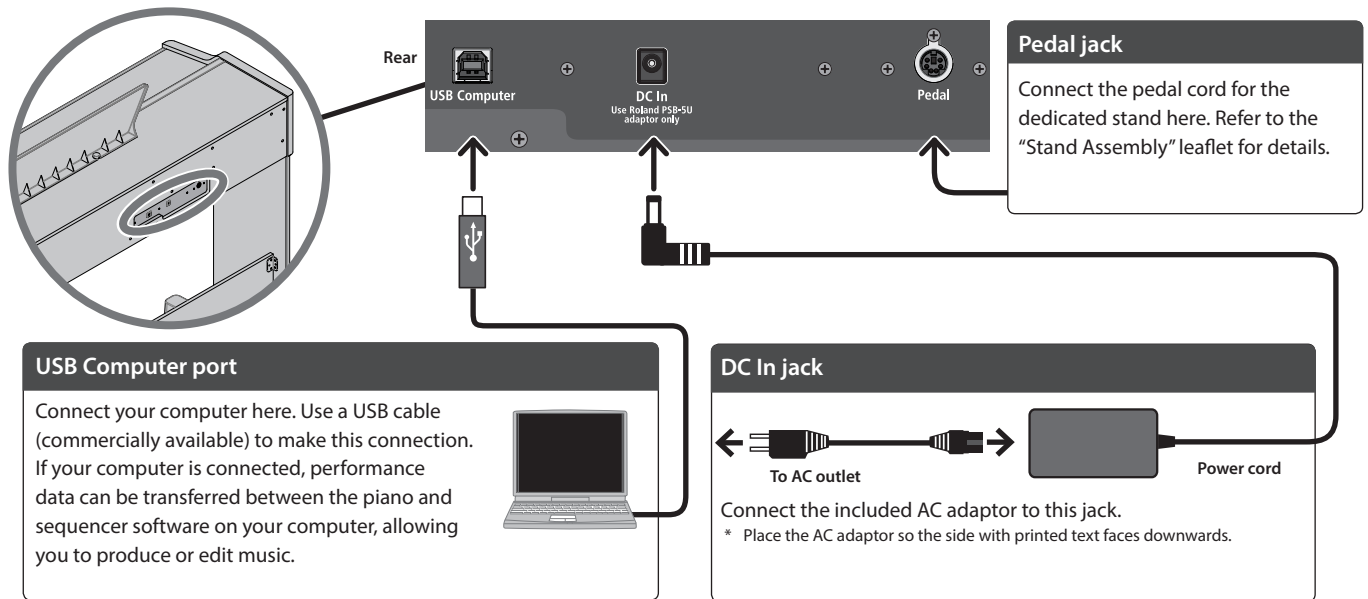

Connecting Other Devices (Bottom)

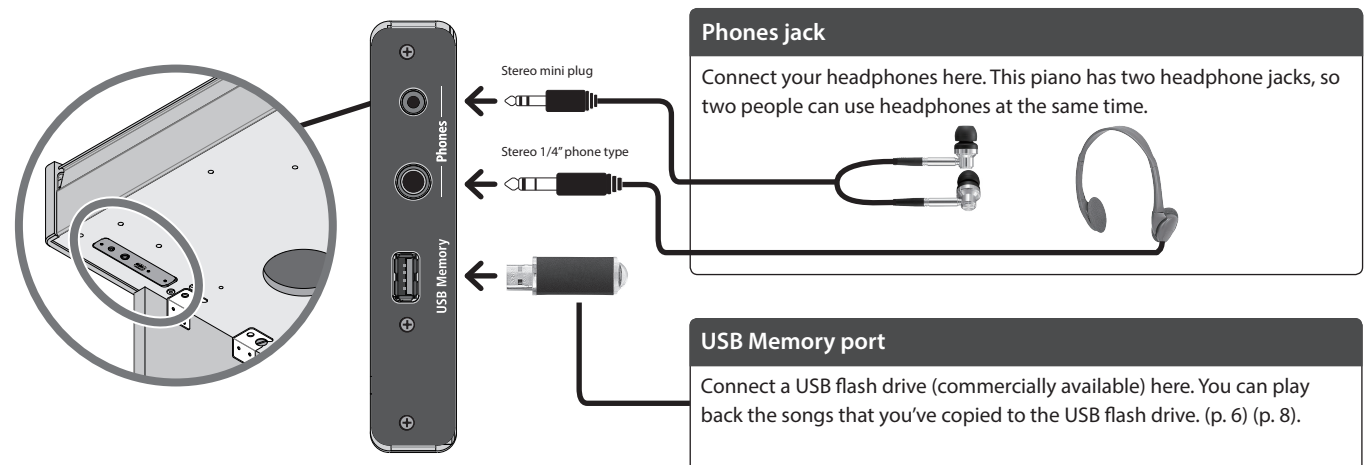

Basic Operations of the RP107

Turning the power on/off

Press the [⏻] (power) button to turn on the power.
 Long-press the [⏻] (power) button to turn the power off.
 * Before turning the unit off, always be sure to turn the volume down. Even with the volume turned down, you might hear some sound when switching the unit on/off. However, this is normal and does not indicate a malfunction.

Adjusting the Volume

Use the two volume buttons to adjust the volume.
 [🔊] (volume +) button: raises the volume.
 [🔊] (volume -) button: lowers the volume.
 These buttons adjust the built-in speaker volume when you are using the speakers, and the buttons adjust the headphones volume when headphones are connected.
 * The indicators to the right of the buttons light up according to the volume (more lights = louder volume). When all of the indicators are lit, the volume is at maximum. When all of the indicators are off, no sound is heard.

The power to this unit will be turned off automatically after a predetermined amount of time has passed since it was last used for playing music, or its buttons or controls were operated (Auto Off function). If you do not want the power to be turned off automatically, disengage the Auto Off function (p. 3).

- When the power is turned off, any settings you were editing will be lost. You must save settings that you want to keep (p. 9).
- To restore power, turn the power on again.

Using the Music Rest

1. Slightly loosen the screws that fasten the music rest (about 2–3 mm), and hook the bottom part of the music rest into the gap between the screws and the piano. While holding the music rest with one hand, use your other hand to turn the screws and stabilize the music rest.

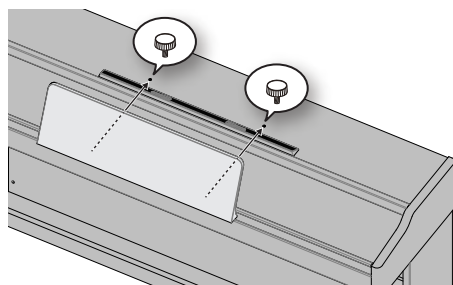

When attaching, firmly insert the music rest as far as it can go, and grip it with your hand so that it doesn't fall over. Take care not to get your hand pinched.

- * Do not apply excessive force to the music rest.
- * When removing the music rest, loosen the screws while holding it with one hand. After you remove the music rest, firmly retighten the screws.

Changing the Settings

Hold down the [⚙️] (settings) button and press the keys to switch between the various functions.
 → “Quick Operations” (p. 2)

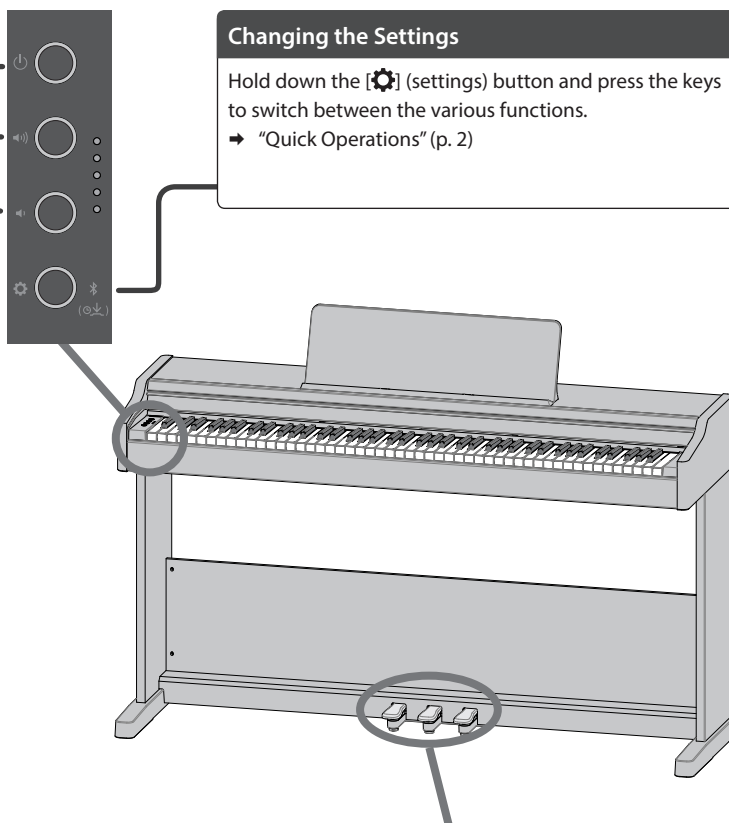

Using the Pedals

By pressing the pedals, you can apply effects to the sound of the piano. The pedals on Roland pianos work the same as typical grand piano pedals.

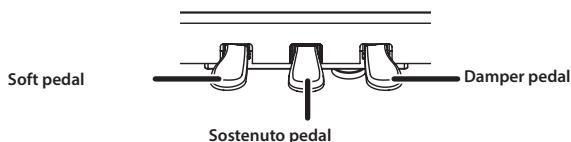

Damper pedal (right)	While this pedal is held down, the notes sustain without a break in the sound, even if you take your fingers off the keys. The resonance of the sound is affected by how deeply you press the pedal. * The higher notes of the piano (from the highest key down around 1½ octaves) linger for a while after you play them even if the pedal is not pressed, like a grand piano.
Sostenuto pedal (center)	When you play a note and then press this pedal before releasing the keys, the sound sustains for only those keys. * This has no effect on notes that you play after pressing the pedal.
Soft pedal (left)	This pedal is used to make the sound softer. Playing with the soft pedal depressed produces a sound that is not as strong as when otherwise played with the equivalent strength. The softness of the tone can be varied subtly by the depth to which you press the pedal. * As this is a rather subtle effect, it may be difficult to notice when playing certain tones or in certain performance situations.

- * When operating the pedal, take care not to pinch your fingers between the moving part and the piano unit. In places where small children are present, make sure that an adult provides supervision and guidance.

- * To prevent malfunction and equipment failure, always turn down the volume, and turn off all the units before making any connections.
- * Never turn off the power, disconnect the USB flash drive or unplug the power cord while this instrument is in the middle of an operation (the topmost three volume indicators blink).
- * Never turn off the power or disconnect a USB flash drive or the power cord while the USB flash drive access indicator is blinking.

English

日本語

Deutsch

Français

Italiano

Español

Português

Nederlands

简体中文

Playing the Piano, Listening to Songs and Practicing

Selecting a Tone

In addition to piano sounds, the piano lets you enjoy performing with many other sounds.

You can also connect the instrument to an app that give you access to even more tones, such as “Do Re Mi” and GM2 tones.

→ “Connecting the Piano and a Mobile Device via Bluetooth” (p. 10)

1. Hold down the [G] button and play a key from A0 to B1. This selects the tone corresponding to the key you pressed.

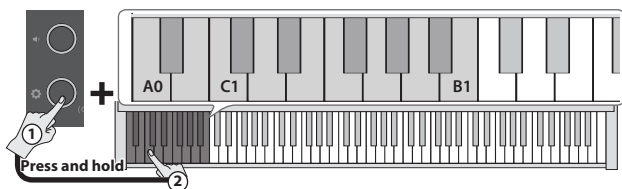

Tone Name	Explanation
Concert Piano (A0)	An extravagant concert grand piano. This is the most recommended piano tone for use in any genre.
Ballad Piano (A#0)	A relaxing grand piano. Good for songs that are more quiet and relaxed.
Mellow Piano (B0)	A grand piano tone that's even more laid back than the Ballad Piano. Recommended for songs with a soft, relaxed mood.
Bright Piano (C1)	A grand piano with a brilliant tone. Recommended for making the piano stand out in an ensemble.
Stage EP (C#1)	The most popular electric piano tone, featuring a characteristic tremolo effect. Good for pop music and ballads.
Pop EP (D1)	An electric piano with an attack that stands out, emphasizing the low and high frequencies. Recommended when performing solos in songs and similar situations.
Magical Piano (D#1)	A piano tone with a bright and sparkling feel, featuring a piano sound plus bell and pad synthesizer sounds.
Harpsichord (E1)	A classical instrument sound used in baroque music. Produces a characteristically delicate sound that's made by plucking strings with a plectrum.
Celesta (F1)	A well-known classical instrument sound used in Tchaikovsky's "Nutcracker Suite". Produces a uniquely brilliant and pleasant tone that's like a glockenspiel.
Vibraphone (F#1)	An instrument that's a larger version of the glockenspiel, with a characteristically spacious and clear tone. Playing in a relaxed way also offers a sound with variation.
Pipe Organ (G1)	A pipe organ that's used in places like churches. Suitable for playing baroque music.
Combo Jz. Organ (G#1)	A tonewheel organ. Often used when playing jazz music.
SymphonicStr1 (A1)	A large string ensemble with a characteristically warm sound. Can be used for both slow and rapid passages. Useful in a variety of situations such as when layered with a piano tone.
Soft Pad (A#1)	A synthesizer tone with a distinctive spacious sound. Useful when layered with instruments like piano or electric piano, giving a quiet warmth to the sound.
Jazz Scat (B1)	Vocal sounds that can be triggered in four stages according to how hard you play the keys (Doo, Doot, Bap and Daw). This lets you enjoy playing a cappella-style passages with a thick sound.

MEMO

Press two keys at the same time to select two different tones that play together with each press of a key. This function is called “Dual Play”.

Playing Back a Song

Here's how you can listen to the built-in songs. The built-in songs are separated into several categories.

→ For details on the built-in songs, refer to “Internal Song List” (p. 18).

Selecting a category

1. Hold down the [G] button and play a key from C2 to G#2, or from F3 to F#3.

This selects the category corresponding to the key you pressed.

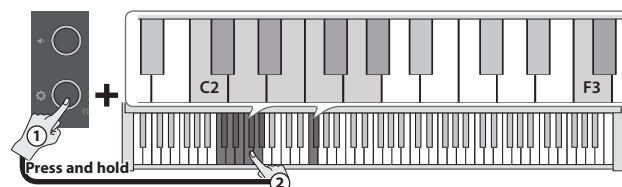

Category name	Explanation
Listening (C2)	Piano songs recommended for listening.
Ensemble (C#2)	Famous songs, mainly classical pieces. These include piano concertos, duets, and jazz arrangements of classical pieces. Since this collection contains songs that are challenging to play, they are recommended for those at intermediate level or above.
Entertainment (D2)	Arrangements of well-known songs from around the world, including pop, jazz, and children's songs, in arrangements that can be enjoyed by a wide range of people from the beginner to the advanced player.
Do Re Mi Lesson (D#2)	You can use these lessons to learn the basics of music, by singing solfège along with the songs or practicing score-reading.
Scales (E2)	Scales in all keys (major scales, minor scales).
Hanon (F2)	Exercises No. 1–20 from Hanon's "The Virtuoso Pianist".
Beyer (F#2)	Beyer's "Vorschule im Klavierspiel" Op.101, No. 1–106.
Burgmüller (G2)	Burgmüller's "25 Études faciles et progressives" Op.100.
Czerny #100 (G#2)	Czerny's "100 Progressive Studies" for piano practice.
USB Memory (F3)	Plays back songs from a USB flash drive. (*)
Internal Memory (F#3)	Plays back a song (only one) that's recorded on the piano.

(*) The RP107 can play back data in the following formats.

- SMF formats 0/1
- Audio files (WAV 44.1 kHz, 16-bit linear)
- Audio files (MP3, 44.1 kHz, 64 kbps–320 kbps)

Selecting a playback method

2. Hold down the [⚙️] button and play a key from C3 to C#3.

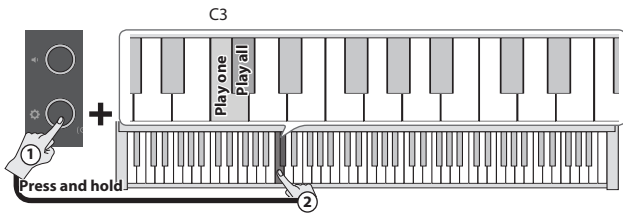

Keys to press	Explanation
Play one song (C3)	Plays one song from the given category.
Play all songs (C#3)	Plays all songs in the given category.

Hold down the [⚙️] button and press the same key again to stop playback.

Changing songs

3. Hold down the [⚙️] button and press a key from D3 to E3.

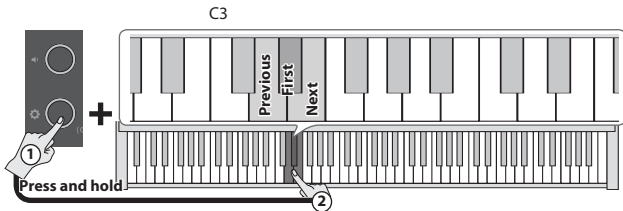

Keys to press	Explanation
Previous song (D3)	This selects the previous song in the given category.
First song (D#3)	This selects the first song in the given category.
Next song (E3)	This selects the next song in the given category.

Practicing with the Metronome

You can play while listening to the metronome. The metronome's tempo and time signature can be changed.

Start and Stop the Metronome

1. Hold down the [⚙️] button and play the C4 key.

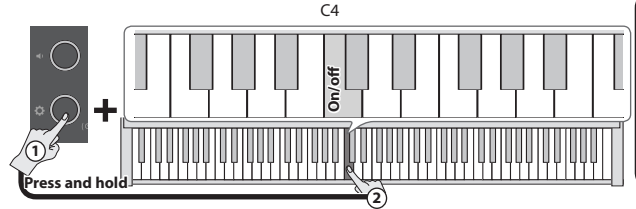

Changing the Metronome's Volume

1. Hold down the [⚙️] button and play a key from A3 to B3.

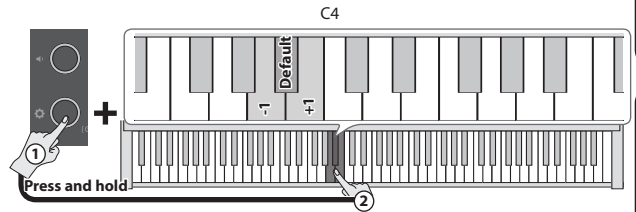

Metronome volume	1–10 (default value: 5)
------------------	-------------------------

Changing the Time Signature

1. Hold down the [⚙️] button and press a key from D4 to E4.

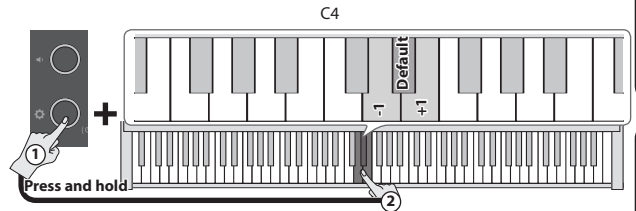

Time signature	0/4 (*2), 2/2, 3/2, 2/4, 3/4, 4/4, 5/4, 6/4, 7/4, 3/8, 6/8, 8/8, 9/8, 12/8 (default value: 4/4)
----------------	---

(*) Each beat plays with the same sound when the metronome plays.

Changing the Tempo

1. Hold down the [⚙️] button and press a key from F#4 to B4.

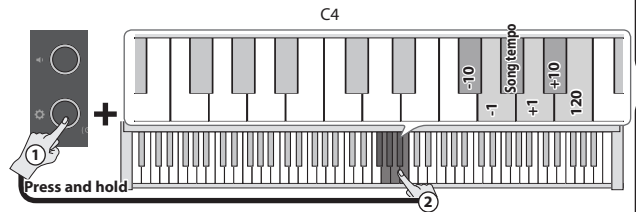

Tempo	10–500 (default: 108)
-------	-----------------------

English

日本語

Deutsch

Français

Italiano

Español

Português

Nederlands

简体中文

Recording a Performance

Recording Your Keyboard Performance

You can record your own keyboard performance, and then play back to check it.

Getting Ready to Record

1. Select the tone that you want to play.

2. You can sound the metronome if you like (p. 7).

* The metronome setting is stored in the song, and you can use the same settings during playback.

Starting/Stopping Recording

3. Hold down the [RECORD] button and press the [VOLUME -] (volume -) button.

The topmost volume indicator blinks, and the instrument enters record standby.

If you decide to cancel recording, press the [RECORD] button.

MEMO

Once the instrument enters record standby, only these functions are available until recording stops: adjusting the volume, starting and stopping the metronome, changing the metronome's volume and changing the tempo.

4. Hold down the [RECORD] button and play the C3 key.

Recording starts after a one-measure count-in.

The topmost volume indicator blinks rapidly during recording.

MEMO

You can also start recording by playing the keyboard instead of pressing the [RECORD] button and C3 key. In this case, a count is not sounded.

5. Play the instrument.

6. To stop recording, hold down the [RECORD] button and press the [VOLUME -] (volume -) button again.

Once all the volume indicators blink, saving is finished.

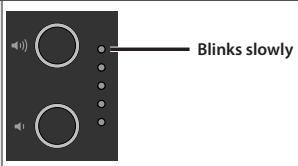
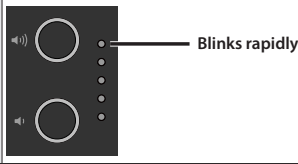
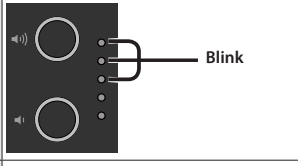
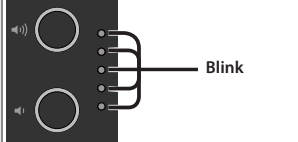
Standby	
Recording	
Now saving the recording	
Save complete	

Listening to the Recorded Performance

7. Hold down the [RECORD] button and play the C3 key.

After you record, the newly recorded song is selected.

The recorded song starts playing back.

If You Want to Redo the Recording

1. Redo the operations from step 3.

* Only one song's worth of performance data can be recorded to internal memory. To rerecord, you must overwrite the existing data.

Exporting Your Performance to a USB Flash Drive

Here's how to copy your recorded song to a USB flash drive.

1. Connect the USB flash drive where you want to copy the data to the USB Memory port.

2. Hold down the [RECORD] button and press the C7 key.

The volume indicators light as shown in the illustration.

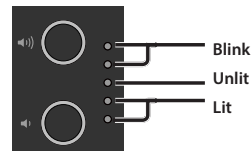

3. Press the [VOLUME +] (volume +) button.

This copies the song.

To cancel, press the [VOLUME -] (volume -) button or the [RECORD] button.

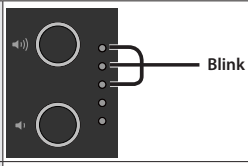
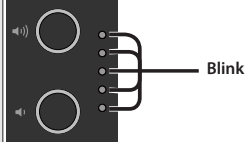
Now copying song	
Copy completed	

* Never turn off the power or disconnect the USB flash drive while a song is being copied.

* You can copy up to 100 songs.

Advanced Features

Outputting Sound from Both Headphones and the Built-in Speakers (Speaker Auto Mute)

By factory default, the built-in speakers are set not to make sound when you connect a pair of headphones into the Phones jack. By changing the settings, you can make sound come from both the headphones and the built-in speakers.

* Changing the settings also changes the tonal character of the sound you hear in your headphones.

1. Press the [⚙️] button while holding down the [🔊] (volume +) button and the [🔊] (volume -) button.
2. Press the [⚙️] button to switch between settings.

When headphones are connected to the Phones jack	Volume indicator display
Sound comes only from headphones (default setting)	
Sound comes from both headphones and built-in speakers	

3. To exit settings, press the [🔊] (volume +) button or the [🔊] (volume -) button.

Saving the Settings (Memory Backup)

This piano remembers the “settings that are saved automatically” even when the power is turned off and then on again. If you set the “Memory Backup” setting, the settings saved by memory backup are stored as well. Other settings return to their default values when you turn the power off and on again.

1. Hold down the [⚙️] button and press the [🔊] (volume +) button.

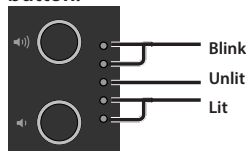

2. Press the [🔊] (volume +) button.

The current settings are saved.

To cancel, press the [🔊] (volume -) button or the [⚙️] button.

Settings that are saved automatically	Page
Speaker volume	p. 5
Headphone volume	p. 5
Bluetooth On/Off	p. 2
USB Audio/Bluetooth Volume	p. 3
Auto-off	p. 3
Settings that are saved by “Memory Backup”	Page
Sound ambience (Ambience)	p. 2
Brilliance (Brilliance)	p. 2
Headphones 3D Ambience	p. 2
Key Touch	p. 3
Master tuning	p. 3
Metronome (Volume)	p. 2
SMF Play Mode	p. 2
Speaker Auto Mute	p. 9

Returning to the Factory Settings (Factory Reset)

Here’s how to restore all registrations and internally saved settings to the factory-set condition. This function is called “Factory Reset”.

NOTE

When you perform a factory reset, all settings are initialized, and the songs recorded in internal memory are erased.

1. Turn on the power while holding down the [🔊] (volume +) and [🔊] (volume -) buttons, and keep holding the [🔊] (volume +) and [🔊] (volume -) buttons.

Take your fingers off the buttons once the volume indicators light up as shown below.

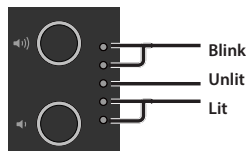

2. Press the [🔊] (volume +) button.

The factory reset is executed.

To cancel, press the [🔊] (volume -) button or the [⚙️] button.

Now executing factory reset	
Completed	

* Never turn off the power while the factory reset is in progress.

3. Once the volume indicators show the “Completed” status, turn the power off and then on again.

English

日本語

Deutsch

Français

Italiano

Español

Português

Nederlands

简体中文

Connecting the Piano and a Mobile Device via **Bluetooth**[®]



Here's What You Can Do

Bluetooth functionality creates a wireless connection between a mobile device such as a smartphone or tablet (subsequently referred to as "mobile device") and the piano, letting you do the following.

→ Play Music Through the Piano's Speakers page 10

Music data stored on your mobile device can be played wirelessly through the piano's speakers.

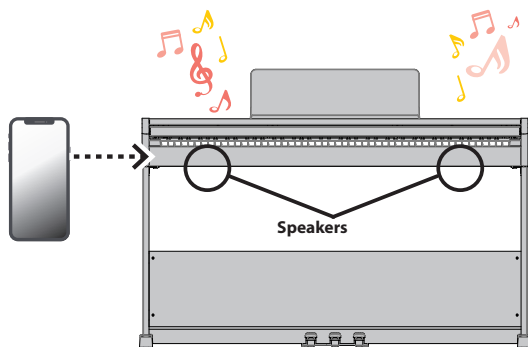

→ Using the Piano with an App page 11

Install the app ("Roland Piano App" by Roland) on your mobile device to exchange data with the piano.

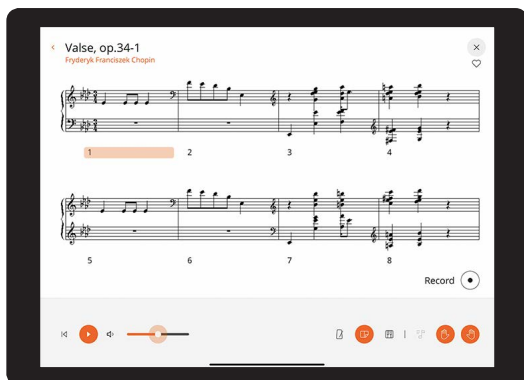

App "Roland Piano App"

Play Music Through the Piano's Speakers

Here's how to configure the settings so that music data saved on your mobile device can be played wirelessly through the piano's speakers.

- * Once a mobile device has been paired with the piano, there is no need to pair again. Refer to the steps in "Connecting an Already-Paired Mobile Device" (p. 11).

Initializing the Settings (Pairing)

This example shows how to configure the settings for an iPad. If you are using an Android device, refer to the instructions for settings in the owner's manual that came with your mobile device.

1. Place the mobile device that you want to connect near the piano.
2. Hold down the [G] button (⌘) on the piano for at least five seconds.

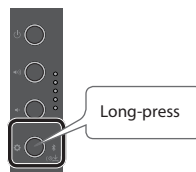

Take your finger off once the [G] button blinks (blue)

3. Turn on the **Bluetooth** function of the mobile device.

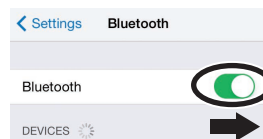

4. Tap "RP107 Audio", shown on the **Bluetooth** device screen of your mobile device.

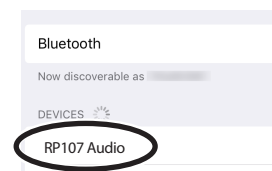

The piano and mobile device are paired. When pairing is completed, information similar to the following is shown.

Mobile device	"RP107 Audio" is added in "My Devices".
Piano	[G] button lights up (blue)

Now you've finished initializing the settings.

Pairing

To use **Bluetooth**, you must first "pair" the piano with your mobile device to create a one-to-one connection between them.

"Pairing" is the procedure of registering (mutually authenticating) your mobile device with the piano.

Pair the devices by following the steps shown for each function.

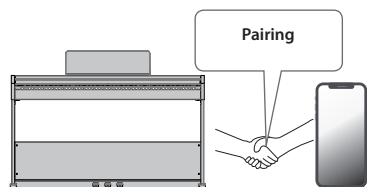

The pairing process

Separate pairing is required for "playing music through the piano's speakers" and for "using the piano with an app". Note that these processes are different.

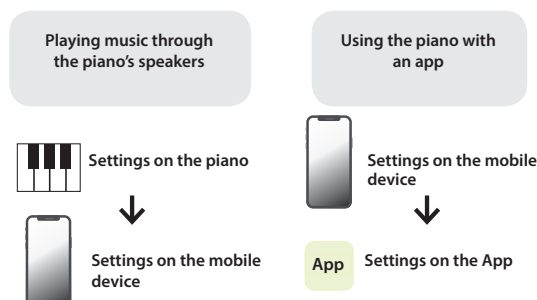

Connecting an Already-Paired Mobile Device

1. Turn on the Bluetooth function of the mobile device.

The piano and mobile device are connected wirelessly.

MEMO

If you were unable to connect using the steps above, tap "RP107 Audio", displayed in the **Bluetooth** device screen of the mobile device.

Playing Back Audio

When you play back music data on the mobile device, the sound is heard from the piano's speakers.

Adjusting the volume of Bluetooth audio

Normally, you should adjust the volume on the mobile device that you're using.

If you've done this and you're still unable to adjust the volume the way you want, refer to the operations below.

1. Hold down the [G] button and press the F7, F#7 or G7 keys to adjust the volume.

Keys to press	Explanation
F7	Decreases the volume by -1.
F#7	Sets the volume to the default (7).
G7	Increases the volume by +1.
Setting range	1-10 (default value: 7)

Using the Piano with an App

Here's how to make the settings to use an app installed on your mobile device along with this piano.

Apps You Can Use with This Piano

App name	Supported OS	Explanation
 Roland Piano App	iOS Android	This app lets you view sheet music in digital form, practice songs as if you were playing a game, or keep a record of your practicing. 

- * Download from the App Store or from Google Play (free).
- * In addition to the above, you can also use music apps (such as GarageBand) that are compatible with **Bluetooth MIDI**.
- * The information provided about apps made by Roland was current when this manual was published. For the latest information, refer to the Roland website.

Making the Settings (Pairing)

You can make settings for using the piano together with an app that's installed on your mobile device. This shows the steps for using the "Roland Piano App" app with the iPad as an example.

- * In the case of "using the piano with an app", settings on the piano are not necessary. Perform operations in the app to pair it with the piano.

1. Turn on the Bluetooth function of the mobile device.

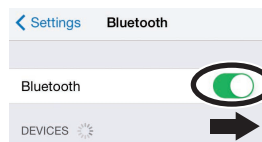

NOTE

Even if the "DEVICES" field shows the name of the device you're using (such as "RP107 MIDI"), do not tap it.

2. Start the app that you installed on your mobile device.

3. Tap "Connection" at the top of the app screen, and tap "Connect Piano".

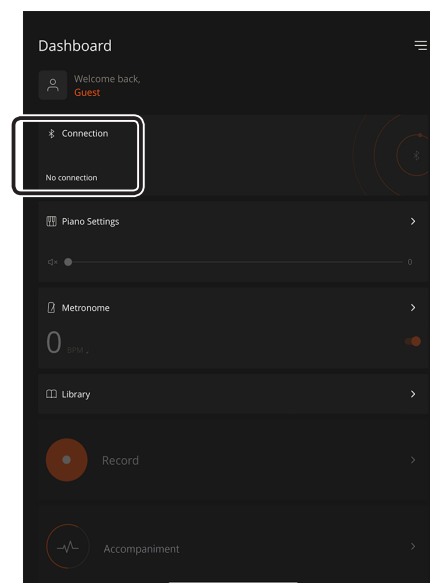

The app screen shows "RP107 MIDI".

4. Tap "RP107 MIDI".

The piano and mobile device are paired. When pairing is completed, information similar to the following is shown.

Mobile device	"RP107 MIDI" is added in the "My Devices" field
Piano	[G] button lights up (blue)

This completes the settings.

If Pairing Doesn't Work

If the pairing process in "Using the Piano with an App" (p. 11) was not successful, try steps 1–4 shown below.

1 Make sure that the piano's Bluetooth function is "On"

1. Hold down the [G3] button and press the G3 key.
The piano's Bluetooth function turns on.

2 Exit all apps on your mobile device

Closing the app

1. Swipe up from the bottom of the home screen, stopping your finger around the middle of the screen. Next, swipe the app screen up.

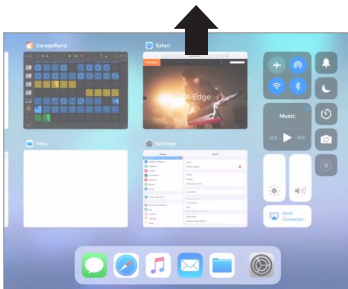

* The method for closing apps may differ depending on your mobile device. Use the method that's appropriate for your device to close the apps.

3 If already paired, cancel pairing, and turn off the Bluetooth function

Clearing the pairing

1. In the mobile device's screen, tap the "i" located beside "Connected", and tap "Forget This Device".

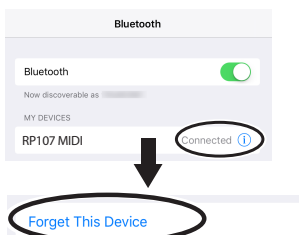

2. Turn the Bluetooth switch off.

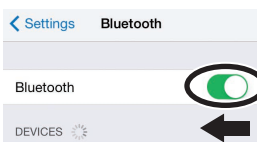

4 Restart your mobile device

5 Perform the pairing procedure of p. 11 from step 1

MEMO

If you've checked these points and the problem still occurs, please refer to the Roland support website.

<https://www.roland.com/support/>

Troubleshooting

Problem	Items to check	Cause/Action	Page
Problems with the piano's sound			
No sound	Is the volume turned down?	Raise the volume.	p. 5
	Could headphones or an adaptor plug be inserted in the Phones jack?	If headphones or an adaptor plug are inserted in the headphones jack, sound is not output from the speakers.	p. 4
	If you want sound to be produced from headphones, is the device connected correctly?		
Pitch of the keyboard or song is incorrect	Could you have made Transpose settings?	Disable transpose in the Transpose settings.	p. 3
	Is the Master Tune setting appropriate?	When shipped from the factory, the reference pitch is set to "442.0 Hz". Check the Master Tuning settings.	p. 3
Sounds are heard twice (doubled) when the keyboard is played	Could "Dual Play" be specified, so that two tones are layered?	Hold down the  (settings) button and press the A0 key to exit Dual Play mode.	p. 6
	Could the piano be connected to an external sequencer?	If you don't want the piano to be played from another sound module, set your music production software's "soft thru" setting to "Off".	-
Reverberation remains even if you defeat the Ambience effect	This simulates the depth and ambience of the acoustic piano's sound, and is not a malfunction. Even if the Ambience effect is off, the acoustic piano's own resonance remains.		-
The sound of the higher notes suddenly changes from a certain key	On an acoustic piano, the higher notes of the piano (from the highest key down around 1½ octaves) fully sustain after you play them even if the damper pedal is not pressed. The sound is also different. In this way, this piano faithfully recreates the sound of an acoustic piano. Also, the key range that is unaffected by the damper pedal changes depending on the transpose settings.		-
When you press a key, the sound of a note you didn't press is also faintly heard	In some cases, a note you play might cause a different note (whose frequency is an integer multiple of the first note) to resonate, producing the sensation that the sound has changed; this is not a malfunction.		-
High-pitched ringing is heard	If you can hear this in headphones: Some piano tones that feature a brilliant and consistent sound include many high-frequency components, which may include some reverberations that could sound metallic. This is a faithful recreation of the original characteristics of a piano, and is not a malfunction. This kind of reverberation tends to be more audible when the more ambience effect is applied, so you might try reducing the ambience effect to help mitigate this issue.		p. 2
	If you can't hear this through headphones: There may be another issue causing this, such as the sound resonating with the piano unit. Please contact your dealer or a Roland customer service center.		-
Low notes sound wrong, or are buzzy	Could the volume be set to maximum?	If the volume is at the maximum, the sound might be distorted depending on how you play the piano. If this occurs, lower the volume.	p. 5
	If you can hear this in headphones: It may be that the piano has malfunctioned. Please contact your dealer or a Roland customer service center.		-
	If you can't hear this through headphones: It may be that the objects near the piano are resonating because of the high volume of sound coming from the speakers. You can take the following measures to minimize resonances. <ul style="list-style-type: none"> • Keep the volume down. • Locate the speakers 10–15 cm (4–6 inch) away from walls or other surfaces. • Move away from the objects that are resonating. 		-
The sound is heard differently depending on the tone settings	When using "Dual Play" which layers two tones, the sound you hear may differ depending on the specific combination. For some combinations, the effect is not applied to the left-hand tone. This is not a malfunction.		-

English

日本語

Deutsch

Français

Italiano

Español

Português

Nederlands

简体中文



Troubleshooting

Problem	Items to check	Cause/Action	Page
Problems with the pedals			
Pedal does not work, or is "stuck"	Is the pedal connected correctly?	Check the pedal jack located on the back of the piano.	p. 4
	Could you have disconnected or connected the pedal cord while the power was on?	If you disconnect the pedal cord while the piano is powered-on, the pedal effect might remain applied. Connect or disconnect the pedal cord while the piano is powered off.	p. 5
	Could Twin Piano be turned on?	If Twin Piano is on, the right pedal will affect only the right-hand keyboard zone and the left pedal will affect only the left-hand keyboard zone.	p. 3
Problems with song playback			
Song volume is inaudible or too low	Is the song playback volume set to "1"?	Raise the song playback volume.	p. 3
Changing the "Song Volume" does not change the volume.	Could the SMF Play Mode be set to "Internal"?	Set the SMF Play Mode to "External".	p. 2
The selected sound changes when you play back a song	Could the SMF Play Mode be set to "Internal"?	Set the SMF Play Mode to "External".	p. 2
Can't play back a song saved in USB flash drive	Is the file extension "WAV" or ".MP3" or ".MID"?	This piano can play back three types of file: WAVE format or MP3 format audio files, and MIDI files.	p. 6
Problems with recording			
Volume differs between recording and playback	Is the song playback volume set too low?	Raise the song playback volume.	p. 3
Other problems			
Can't change the settings	Is the topmost volume indicator blinking rapidly?	If the topmost volume indicator is blinking rapidly, the piano is in record standby mode, or is currently recording. In this state, only these functions are available: adjusting the volume, starting and stopping the metronome, changing the metronome's volume and changing the tempo.	p. 8
Even though you're using headphones to mute the sound, a thumping sound is heard when you play the keyboard	The keyboard of this piano is designed to simulate the mechanism of an acoustic piano. Even on an acoustic piano, a thumping sound is actually being produced when you press a key. Such sounds do not indicate a malfunction.		–
Power turns off on its own	Could you have made settings so that the power automatically turns off when the piano has not been used for a time?	If you don't need the power to turn off automatically, turn the Auto Off setting "Off".	p. 3
	When trying to play an SMF or audio file recorded at an extremely loud volume from a USB flash drive, the protective circuit of this unit may activate and shut off the power.	Lower the song playback volume.	p. 3
Power does not turn on	Is the AC adaptor connected correctly?		p. 4
Even-numbered or odd-numbered volume indicators are alternately blinking	A system error has occurred. Turn the piano off and on again. If this doesn't solve the problem, perform a factory reset.		p. 9



USING THE UNIT SAFELY

INSTRUCTIONS FOR THE PREVENTION OF FIRE, ELECTRIC SHOCK, OR INJURY TO PERSONS

About ⚠ WARNING and ⚠ CAUTION Notices

 WARNING	Used for instructions intended to alert the user to the risk of death or severe injury should the unit be used improperly.
 CAUTION	Used for instructions intended to alert the user to the risk of injury or material damage should the unit be used improperly. * Material damage refers to damage or other adverse effects caused with respect to the home and all its furnishings, as well to domestic animals or pets.

About the Symbols

	The ⚠ symbol alerts the user to important instructions or warnings. The specific meaning of the symbol is determined by the design contained within the triangle. In the case of the symbol at left, it is used for general cautions, warnings, or alerts to danger.
	The ⓧ symbol alerts the user to items that must never be carried out (are forbidden). The specific thing that must not be done is indicated by the design contained within the circle. In the case of the symbol at left, it means that the unit must never be disassembled.
	The ⚡ symbol alerts the user to things that must be carried out. The specific thing that must be done is indicated by the design contained within the circle. In the case of the symbol at left, it means that the power-cord plug must be unplugged from the outlet.

ALWAYS OBSERVE THE FOLLOWING

WARNING

Concerning the Auto Off function

The power to this unit will be turned off automatically after a predetermined amount of time has passed since it was last used for playing music, or its buttons or controls were operated (Auto Off function). If you do not want the power to be turned off automatically, disengage the Auto Off function (p. 3).



Use only the supplied AC adaptor and the correct voltage

Be sure to use only the AC adaptor supplied with the unit. Also, make sure the line voltage at the installation matches the input voltage specified on the AC adaptor's body. Other AC adaptors may use a different polarity, or be designed for a different voltage, so their use could result in damage, malfunction, or electric shock.



Use only the supplied power cord

Use only the attached power cord. Also, the supplied power cord must not be used with any other device.



CAUTION

Cautions when moving this unit

If you need to move the instrument, take note of the precautions listed below. At least two persons are required to safely lift and move the unit. It should be handled carefully, all the while keeping it level. Make sure to have a firm grip, to protect yourself from injury and the instrument from damage.



- Check to make sure the Screws securing the unit to the stand have not become loose. Fasten them again securely whenever you notice any loosening.
- Disconnect the power cord.
- Disconnect all cords coming from external devices.
- Close the lid.
- Remove the music stand.

Take care so as not to get fingers pinched

When handling the following moving parts, take care so as not to get fingers, toes, etc., pinched. Whenever a child uses the unit, an adult should be on hand to provide supervision and guidance.



- Keyboard Cover (p. 4)
- Pedals (p. 5)

Precautions concerning use of bench

When using the bench, please observe the following points:

- Do not use the bench as a toy, or as a stepping stool.
- Do not allow two or more persons to sit on the bench.
- Do not sit on the bench if the bolts holding the bench legs are loose. (If the bolts are loose, immediately re-tighten them using the supplied tool.)



Keep small items out of the reach of children

To prevent accidental ingestion of the parts listed below, always keep them out of the reach of small children.

- Included Parts
Screws



IMPORTANT NOTES

Power Supply

- Place the AC adaptor so the side with the indicator faces upwards. The indicator will light when you plug the AC adaptor into an AC outlet.

Placement

- Do not allow objects to remain on top of the keyboard. This can be the cause of malfunction, such as keys ceasing to produce sound.
- Depending on the material and temperature of the surface on which you place the unit, its rubber feet may discolor or mar the surface.

Care of the Keyboard

- Do not write on the keyboard with any pen or other implement, and do not stamp or place any marking on the instrument. Ink will seep into the surface lines and become unremovable.
- Do not affix stickers on the keyboard. You may be unable to remove stickers that use strong adhesives, and the adhesive may cause discoloration.
- To remove stubborn dirt, use a commercially available keyboard cleaner that does not contain abrasives. Start by wiping lightly. If the dirt does not come off, wipe using gradually increasing amounts of pressure while taking care not to scratch the keys.

Repairs and Data

- Before sending the unit away for repairs, be sure to make a backup of the data stored within it; or you may prefer to write down the needed information. Although we will do our utmost to preserve the data stored in your unit when we carry out repairs, in some cases, such as when the memory section is physically damaged, restoration of the stored content may be impossible. Roland assumes no liability concerning the restoration of any stored content that has been lost.

Additional Precautions

- Any data stored within the unit can be lost as the result of equipment failure, incorrect operation, etc. To protect yourself against the irretrievable loss of data, try to make a habit of creating regular backups of the data you've stored in the unit.
- Roland assumes no liability concerning the restoration of any stored content that has been lost.
- The sound of keys being struck and vibrations produced by playing an instrument can be transmitted through a floor or wall to an unexpected extent. Please take care not to cause annoyance to others nearby.
- Do not apply undue force to the music rest while it is in use.

Using External Memories

- Please observe the following precautions when handling external memory devices. Also, make sure to carefully observe all the precautions that were supplied with the external memory device.
 - Do not remove the device while reading/writing is in progress.
 - To prevent damage from static electricity, discharge all static electricity from your person before handling the device.

Caution Regarding Radio Frequency Emissions

- The following actions may subject you to penalty of law.
 - Disassembling or modifying this device.
 - Removing the certification label affixed to the back of this device.
 - Using this device in a country other than where it was purchased

Intellectual Property Right

- It is forbidden by law to make an audio recording, video recording, copy or revision of a third party's copyrighted work (musical work, video work, broadcast, live performance, or other work), whether in whole or in part, and distribute, sell, lease, perform or broadcast it without the permission of the copyright owner.
- Do not use this product for purposes that could infringe on a copyright held by a third party. We assume no responsibility whatsoever with regard to any infringements of third-party copyrights arising through your use of this product.
- The copyright of content in this product (the sound waveform data, style data, accompaniment patterns, phrase data, audio loops and image data) is reserved by Roland Corporation.
- Purchasers of this product are permitted to utilize said content (except song data such as Demo Songs) for the creating, performing, recording and distributing original musical works.
- Purchasers of this product are NOT permitted to extract said content in original or modified form, for the purpose of distributing recorded medium of said content or making them available on a computer network.
- This product contains eParts integrated software platform of eSOL Co.,Ltd. eParts is a trademark of eSOL Co., Ltd. in Japan.
- The **Bluetooth**® word mark and logos are registered trademarks owned by **Bluetooth SIG, Inc.** and any use of such marks by Roland is under license.
- This Product uses the Source Code of µT-Kernel under T-License 2.0 granted by the T-Engine Forum (www.tron.org).
- This product includes third party open source software.
 - Copyright © 2009-2018 Arm Limited. All rights reserved.
 - Licensed under the Apache License, Version 2.0 (the "License");
 - You may obtain a copy of the License at <http://www.apache.org/licenses/LICENSE-2.0>
 - Copyright © 2018 STMicroelectronics. All rights reserved.
 - This software component is licensed by ST under BSD 3-Clause license, the "License";
 - You may obtain a copy of the License at <https://opensource.org/licenses/BSD-3-Clause>
 - This product is using the Jansson (<http://www.digip.org/jansson/>) source code.
 - Copyright © 2009-2016 Petri Lehtinen <petri@digip.org> Released under the MIT license
 - <http://opensource.org/licenses/mit-license.php>
- Roland, SuperNATURAL, and Roland Piano App are either registered trademarks or trademarks of Roland Corporation in the United States and/or other countries.
- Company names and product names appearing in this document are registered trademarks or trademarks of their respective owners.

Main Specification

Sound generator	Piano Sound: SuperNATURAL Piano
Keyboard	PHA-4 Standard Keyboard: with Escapement and Ivory Feel (88 keys)
Bluetooth	Bluetooth Ver 4.2 Supported profiles: A2DP (Audio), GATT (MIDI over Bluetooth Low Energy) Supported codec: SBC (compatible with SCMS-T content protection)
Power Supply	AC Adaptor
Power consumption	8 W (When using the included AC adaptor)
	Approximate power consumption when playing the piano at medium volume: 4 W Power consumption when sound has not been played after power-on: 3 W
Dimensions	With music rest: 1,378 (W) x 410 (D) x 982 (H) mm 54-1/4 (W) x 16-3/16 (D) x 38-11/16 (H) inches
Weight	37.0 kg/82.0 lbs
Option	Owner's Manual, Leaflet "USING THE UNIT SAFELY", Leaflet "Assembling the RP107", AC adaptor, Power cord

* This document explains the specifications of the product at the time that the document was issued. For the latest information, refer to the Roland website.

English

日本語

Deutsch

Français

Italiano

Español

Português

Nederlands

简体中文

Internal Song List

No.	Song Name	Composer
Listening		
1	Valse, op.34-1	Fryderyk Franciszek Chopin
2	Polonaise op.53	Fryderyk Franciszek Chopin
3	Nocturne No.20	Fryderyk Franciszek Chopin
4	Die Forelle	Franz Peter Schubert, Arranged by Franz Liszt
5	Reflets dans l'Eau	Claude Achille Debussy
6	La Fille aux Cheveux de Lin	Claude Achille Debussy
7	La Campanella	Franz Liszt
8	Scherzo No.2	Fryderyk Franciszek Chopin
9	Barcarolle	Fryderyk Franciszek Chopin
10	Zhavoronok	Mikhail Ivanovich Glinka, Arranged by Mily Alexeyevich Balakirev
Ensemble		
1	Piano Concerto No.1 *	Peter Ilyich Tchaikovsky
2	Piano Concerto No.2 *	Sergei Rachmaninoff
3	Canon (Jazz Arrangement) *	Johann Pachelbel
4	Sicilienne (Jazz Arrangement) *	Gabriel Fauré
5	Berceuse from Dolly Suite	Gabriel Fauré
6	Le jardin féerique from Ma mère l'Oye	Maurice Ravel
7	Le Quattro Stagioni "La Primavera" *	Antonio Vivaldi
8	Marche Militaire Nr.1 *	Franz Peter Schubert
9	Waltz from the Sleeping Beauty *	Peter Ilyich Tchaikovsky
10	L'Apprenti sorcier *	Paul Dukas
11	Salut d'Amour	Edward Elgar
12	Pavane pour une infante défunte	Maurice Ravel
13	Menuett G Dur BWV Anh.114	Johann Sebastian Bach
14	Präludium C Dur BWV846	Johann Sebastian Bach
15	Türkischer Marsch	Wolfgang Amadeus Mozart
16	Für Elise	Ludwig van Beethoven
17	Türkischer Marsch	Ludwig van Beethoven
18	Auf Flügeln des Gesanges	Felix Mendelssohn
19	Étude, op.10-3	Fryderyk Franciszek Chopin
20	Valse, op.64-1	Fryderyk Franciszek Chopin
21	Fantaisie-Impromptu	Fryderyk Franciszek Chopin
22	Träumerei	Robert Alexander Schumann
23	Dolly's Dreaming Awakening	Theodor Oesten
24	Brautchor	Wilhelm Richard Wagner
25	Liebesträume Nr.3	Franz Liszt
26	Ungarische Tänze Nr.5	Johannes Brahms
27	Clair de Lune	Claude Achille Debussy
28	1ère Arabesque	Claude Achille Debussy
29	Golliwog's Cakewalk	Claude Achille Debussy
30	Je te veux	Erik Satie
Entertainment		
1	Polovtsian Dances	Alexander Borodin
2	Ombra mai fù	George Frideric Handel
3	Lascia ch'io pianga	George Frideric Handel
4	Twinkle Twinkle Little Star	French Folk Song
5	Mary Had a Little Lamb	Traditional
6	Bear Song	American Folk Song
7	Ich Bin Ein Musikante	German Folk Song

No.	Song Name	Composer
8	Grand Father's Clock	Henry Work
9	Jingle Bells	James Pierpont
10	We Wish You a Merry Christmas	Carol
11	Silent Night	Franz Gruber
12	Amazing Grace	Hymn
13	Lavender's Blue	Traditional
14	Aura Lee	George R. Poulton
15	Auld Lang Syne	Traditional
16	Greensleeves	Traditional
17	Maple Leaf Rag	Scott Joplin
18	The Entertainer	Scott Joplin
19	When The Saints Go Marching In	Traditional
20	Little Brown Jug	Joseph Winner
DoReMi		
1-15	Training No.1 - 15	Roland Corporation
16	Twinkle Twinkle Little Star	French Folk Song
17	Summ,Summ,Summ	Traditional
18	Frog Song	German Folk Song
19	The Cuckoo	Traditional
20	Oh! Susanna	Stephen Foster
21	Let's Clap Hands	Traditional
22	Das klinget so herrlich	Wolfgang Amadeus Mozart
23	Wiegenlied	Johannes Brahms
24	Les Patineurs	Émile Waldteufel
25	Minuet	Johann Sebastian Bach
26	Old Folks At Home	Stephen Foster
27	Deck the Halls	Carol
28	Danny Boy	Irish Song
29	Korobeiniki	Russian Folk Song
30	Sakura Sakura	Japanese Folk Song

No.	Song Name	Composer
Scales		
1–36	Major Scales, Minor Scales	–
Hanon		
1–20	1–20	Charles-Louis Hanon
Beyer		
1–106	1–106	Ferdinand Beyer
Burgmuller		
1	Openness	Johann Friedrich Franz Burgmüller
2	Arabesque	
3	Pastoral	
4	A Small Gathering	
5	Innocence	
6	Progress	
7	The Clear Stream	
8	Gracefulness	
9	The Hunt	
10	Tender Flower	
11	The Young Shepherdess	
12	Farewell	
13	Consolation	
14	Austrian Dance	
15	Ballad	
16	Sighing	
17	The Chatterbox	
18	Restlessness	
19	Ave Maria	
20	Tarantella	
21	Angelic Harmony	
22	Gondola Song	
23	The Return	
24	The Swallow	
25	The Knight Errant	
Czerny 100		
1–100	1–100	Carl Czerny

* All rights reserved. Unauthorized use of this material for purposes other than private, personal enjoyment is a violation of applicable laws.

* Songs marked by an asterisk (*) are arranged by Roland Corporation. The copyrights to these songs are owned by the Roland Corporation.

* Songs in Listening category are piano solos. They have no accompaniment.

* The performance data for the tone demos and the internal songs is not transmitted from the USB Computer port or via **Bluetooth** (MIDI).

* If the SMF Play Mode is set to "Internal, (p. 2)" there will be some parts whose volume does not change when you adjust the Song Volume value (p. 3). If the SMF Play Mode is set to "External", the volume of all parts will change.

English

日本語

Deutsch

Français

Italiano

Español

Português

Nederlands

简体中文

Index

A		U	
Add ambience to the sound	2	USB Audio/ Bluetooth Volume.....	3, 11
Adjust the brightness of the sound	2	USB Computer port	4
Ambience	2	USB Memory port.....	4
App	11	USB Memory.....	8
Auto Memory Backup	9	V	
Auto-off	3	Volume	3, 5
B		(Volume-) button	5
Bluetooth	2, 10	(Volume+) button.....	5
Brilliance	2	D	
D		Damper pedal	5
Damper pedal	5	Damper resonance.....	2
Damper resonance.....	2	DC In jack.....	4
DC In jack.....	4	Dual Play	2, 6
Dual Play	2, 6	F	
F		Factory reset	9
Factory reset	9	H	
H		Headphones	4, 9
Headphones	4, 9	I	
I		Internal.....	2, 6, 18
Internal.....	2, 6, 18	K	
K		Keyboard cover	4
Keyboard cover	4	Key Touch	3
Key Touch	3	M	
M		Master tuning.....	3
Master tuning.....	3	Memory backup	9
Memory backup	9	Metronome.....	2
Metronome.....	2	Music Rest	5
Music Rest	5	P	
P		Pairing.....	10, 11
Pairing.....	10, 11	Pedal	5
Pedal	5	Pedal jack.....	4
Pedal jack.....	4	Phones jack.....	4
Phones jack.....	4	Play back or stop a song.....	2
Play back or stop a song.....	2	(POWER) button	5
(POWER) button	5	R	
R		Recording	8
Recording	8	S	
S		Saving the settings.....	9
Saving the settings.....	9	Select a song	2
Select a song	2	(Settings) button.....	2
(Settings) button.....	2	SMF Play Mode	2
SMF Play Mode	2	Soft pedal	5
Soft pedal	5	Song volume	3
Song volume	3	Sostenuto pedal	5
Sostenuto pedal	5	Speaker Auto Mute	9
Speaker Auto Mute	9	T	
T		Tempo.....	2
Tempo.....	2	Time signature.....	2
Time signature.....	2	Tones.....	2, 6
Tones.....	2, 6	Transpose	3
Transpose	3	Twin Piano.....	3
Twin Piano.....	3		