

# KAWAI

## NOVUS NV10S / NV5S Owner's Manual

---

Important Information

---

Preparation

---

Basic Operation

---

Adjustments & Settings

---

Appendix

EN

# Important Safety Instructions

## SAVE THESE INSTRUCTIONS

INSTRUCTIONS PERTAINING TO A RISK OF FIRE, ELECTRIC SHOCK, OR INJURY TO PERSONS



### WARNING

TO REDUCE THE RISK OF FIRE OR ELECTRIC SHOCK, DO NOT EXPOSE THIS PRODUCT TO RAIN OR MOISTURE.

**AVIS : RISQUE DE CHOC ELECTRIQUE - NE PAS OUVRIR.**

TO REDUCE THE RISK OF ELECTRIC SHOCK, DO NOT REMOVE COVER (OR BACK). NO USER-SERVICEABLE PARTS INSIDE. REFER SERVICING TO QUALIFIED SERVICE PERSONNEL.



The lightning flash with arrowhead symbol, within an equilateral triangle, is intended to alert the user to the presence of uninsulated "dangerous voltage" within the product's enclosure that may be of sufficient magnitude to constitute a risk of electric shock to persons.



The exclamation point within an equilateral triangle is intended to alert the user to the presence of important operating and maintenance (servicing) instructions in the literature accompanying the product.

### Examples of Picture Symbols



Denotes that care should be taken. The example instructs the user to take care not to allow fingers to be trapped.



Denotes a prohibited operation. The example instructs that disassembly of the product is prohibited.





Denotes an operation that should be carried out. The example instructs the user to remove the power cord plug from the AC outlet.

### Read all the instructions before using the product.

- 1) Read these instructions.
- 2) Keep these instructions.
- 3) Heed all warnings.
- 4) Follow all instructions.
- 5) Do not use this apparatus near water.
- 6) Clean only with dry cloth.
- 7) Do not block any ventilation openings. Install in accordance with the manufacturer's instructions.
- 8) Do not install near any heat sources such as radiators, heat registers, stoves, or other apparatus (including amplifiers) that produce heat.
- 9) Do not defeat the safety purpose of the polarized or grounding-type plug. A polarized plug has two blades with one wider than the other. A grounding type plug has two blades and a third grounding prong. The wide blade or the third prong are provided for your safety. If the provided plug does not fit into your outlet, consult an electrician for replacement of the obsolete outlet.
- 10) Protect the power cord from being walked on or pinched particularly at plugs, convenience receptacles, and the point where they exit from the apparatus.
- 11) Only use attachments/accessories specified by the manufacturer.
- 12) Use only with the cart, stand, tripod, bracket, or table specified by the manufacturer, or sold with the apparatus. When a cart is used, use caution when moving the cart/apparatus combination to avoid injury from tip-over. 
- 13) Unplug this apparatus during lightning storms or when unused for long periods of time.
- 14) Refer all servicing to qualified service personnel. Servicing is required when the apparatus has been damaged in any way, such as power-supply cord or plug is damaged, liquid has been spilled or objects have fallen into the apparatus, the apparatus has been exposed to rain or moisture, does not operate normally, or has been dropped.

# Règles de sécurité (Supplémentaires pour le Canada)

## CONSERVEZ CES INSTRUCTIONS

	<b>CAUTION</b> RISK OF ELECTRIC SHOCK DO NOT OPEN		<b>AVERTISSEMENT</b> POUR REDUIRE LES RISQUES D'INCENDIE OU D'ELECTROCUTION, PROTEGEZ CET APPAREIL DE LA PLUIE OU DE L'HUMIDITE.
---	---	---	---

### AVIS : RISQUE DE CHOC ELECTRIQUE - NE PAS OUVRIR.

POUR REDUIRE LES RISQUES D'INCENDIE OU D'ELECTROCUTION, NE DEMONTEZ PAS LE COUVERCLE (OU L'ARRIERE). A L'INTERIEUR, AUCUNE PARTIE N'EST REPARABLE PAR L'UTILISATEUR. POUR LA MAINTENANCE, ADRESSEZ-VOUS A DU PERSONNEL QUALIFIE.





Le symbole de l'éclair avec une pointe de flèche à l'intérieur d'un triangle équilatéral met en garde l'utilisateur contre la présence de tension dangereuse, non isolée, à l'intérieur de l'appareil, dont l'amplitude peut être suffisante pour induire un risque d'électrocution d'une personne.



Le point d'exclamation à l'intérieur d'un triangle équilatéral alerte l'utilisateur de la présence de règles d'utilisation et d'entretien importantes dans la notice qui accompagne l'appareil.

### Exemples de symboles graphiques

	Indique que des précautions doivent être prises. L'exemple indique à l'utilisateur qu'il doit faire attention à ne pas se faire coincer les doigts.
	Indique une manipulation interdite. L'exemple indique que le démontage de l'appareil est interdit.
	Indique qu'une manipulation doit être effectuée. L'exemple indique à l'utilisateur qu'il doit débrancher le câble d'alimentation de la prise secteur.



### AVERTISSEMENT

Indique un risque potentiel qui peut entraîner la mort, ou de graves lésions, si l'appareil n'est pas manipulé correctement.

Faite attention de ne pas introduire un produit étranger à l'intérieur de l'appareil.

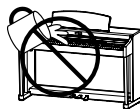

L'introduction d'eau, d'aiguilles ou d'épingles à cheveux, peut provoquer une panne ou un court-circuit. Ce produit doit être mis à l'abri des écoulements ou projections d'eau. Ne jamais placer sur le produit des objets contenant des liquides, tels que des vases ou autres récipients.

Ce produit n'est pas totalement déconnecté du circuit électrique lorsqu'il est mis hors tension par le bouton d'arrêt. Si l'appareil ne doit pas être utilisé pendant une longue période, débranchez le câble d'alimentation de la prise secteur.



- Si vous ne le faisiez pas la foudre pourrait provoquer un incendie.
- Si vous ne le faisiez pas, la surchauffe de l'appareil pourrait provoquer un incendie.

Il est recommandé de placer l'instrument à proximité de la prise de courant et de positionner le câble d'alimentation secteur de sorte qu'il puisse être débranché rapidement en cas d'urgence, le courant électrique étant toujours présent tant que la prise est branchée même si le bouton de mise en marche est en position Arrêt.

### [Seuls les produits avec 3P fiche]

#### INSTRUCTIONS DE MISE À LA TERRE

Ce produit doit être mis à la terre. En cas de défaillance matérielle ou de panne, la mise à la terre fournit un chemin de moindre résistance au courant électrique afin de réduire le risque d'électrocution. Ce produit est équipé d'un câble avec un conducteur de protection et une fiche de mise à la terre. La fiche doit être branchée dans une prise appropriée correctement installée et mise à la terre conformément à tous les codes et règlements locaux.

DANGER - La connexion incorrecte du conducteur de protection peut présenter un risque d'électrocution.

Consultez un électricien ou un réparateur qualifié si vous avez des doutes en ce qui concerne la mise à la terre du produit. Ne modifiez pas la fiche fournie avec le produit – si elle n'est pas adaptée à la prise, faites installer une prise correcte par un électricien qualifié.



### PRECAUTION

Indique un risque potentiel qui peut entraîner la détérioration, ou des dommages, pour l'appareil ou ses propriétés, si celui-ci n'est pas manipulé correctement.

Description de la l'emplacement de la référence (Le cas échéant):

Anglais phrase: The nameplate label is located on the underside of the instruments, as indicated below.

Français phrase: La référence commerciale est inscrite sur une étiquette en dessous de votre instrument, conformément à l'indication ci-dessous.

Votre piano doit être placé à un endroit tel que sa position n'altère pas sa propre ventilation. Gardez une distance minimum de 5 cm autour de l'instrument pour une aération suffisante.

**WARNING - When using electric products, basic precautions should always be followed, including the following.**



## WARNING

Indicates a potential hazard that could result in death or serious injury if the product is handled incorrectly.

**The product should be connected to an AC outlet of the specified voltage.**

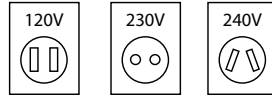

- If you are going to use an AC power cord, make sure that it has the correct plug shape and conforms to the specified power voltage.
- Failure to do so may result in fire.

**Do not insert or disconnect the power cord plug with wet hands.**



Doing so may cause electric shock.

**Take care not to allow any foreign matter to enter the product.**

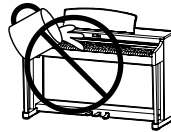

Entry of water, needles or hair pins may result in breakdown or short-circuit. The product shall not be exposed to dripping or splashing. No objects filled with liquids, such as vases, shall be placed on the product.

**The chair must be used properly (it must be used only when playing the product).**

- Do not play with it or stand on it.
- Only one person is allowed to sit on it.
- Do not sit on it when opening the lid.
- Re-tighten the bolts occasionally.

Doing so may cause the chair to fall over or your fingers to be trapped, resulting in injury.

**When using the headphones, do not listen for long periods of time at high volume levels.**

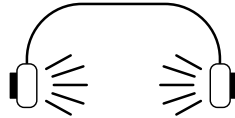

Doing so may result in hearing problems.

**Do not lean against the keyboard.**

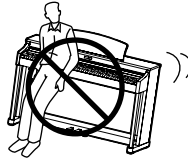

Doing so may cause the product to fall over, resulting in injury.

**Do not disassemble, repair or modify the product.**

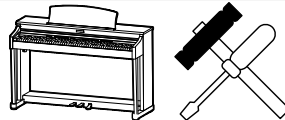

Doing so may result in product breakdown, electric shock or short-circuit.

**When disconnecting the AC power cord's plug, always hold the plug and pull it to remove it.**



Pulling the AC power cord itself may damage the cord, causing a fire, electric shock or short-circuit.

**The product is not completely disconnected from the power supply even when the power switch is turned off. If the product will not be used for a long time, unplug the AC power cord from the AC outlet.**



- Failure to do so may cause fire in case of lightning.
- Failure to do so may over-heat the product, resulting in fire.

**This product may be equipped with a polarized line plug (one blade wider than the other). This is a safety feature. If you are unable to insert the plug into the outlet, contact an electrician to replace your obsolete outlet. Do not defeat the safety purpose of the plug.**

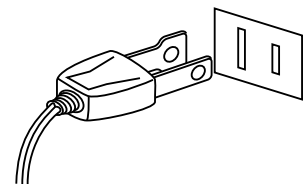

**This product shall be near the AC outlet and the power cord plug in a position so that it can readily be disconnected in an emergency because electricity is always charging while the plug is in the AC outlet even in a power switch off condition.**



## CAUTION

Indicates a potential hazard that could result in injury or damage to the product or other property if the product is handled incorrectly.

**Do not use the product in the following areas.**

- Areas, such as those near windows, where the product is exposed to direct sunlight
- Extremely hot areas, such as near a heater
- Extremely cold areas, such as outside
- Extremely humid areas
- Areas where a large amount of sand or dust is present
- Areas where the product is exposed to excessive vibrations

Using the product in such areas may result in product breakdown. Use the product only in moderate climates (not in tropical climates).

**When you close the keyboard cover, close it gently.**

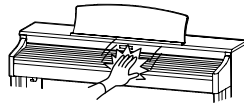

Closing it roughly may trap your fingers, resulting in injury.

**Before connecting cords, make sure that the power to this product and other devices is turned OFF.**

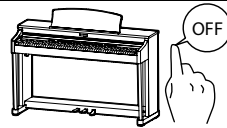

Failure to do so may cause breakdown of this product and other devices.

**Do not drag the product on the floor. Take care not to drop the product.**

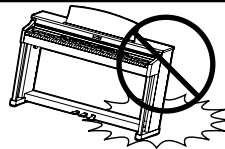

Please lift up the product when moving it. Please note that the product is heavy and must be carried by more than two persons. Dropping the product may result in breakdown.

**Do not place the product near electrical appliances such as TVs and radios.**

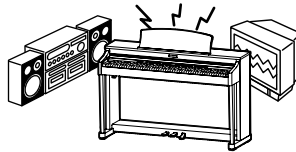

- Doing so may cause the product to generate noise.
- If the product generates noise, move the product sufficiently away from the electrical appliance or connect it to another AC outlet.

**When connecting the AC power cord and other cords, take care not to get them tangled.**

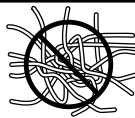

Failure to do so may damage them, resulting in fire, electric shock or short-circuit.

**Do not wipe the product with benzene or thinner.**



- Doing so may result in discoloration or deformation of the product.
- When cleaning the product, put a soft cloth in lukewarm water, squeeze it well, then wipe the product.

**Do not stand on the product or exert excessive force.**



Doing so may cause the product to become deformed or fall over, resulting in breakdown or injury.

**Do not place naked flame, such as lighted candles on the product.**

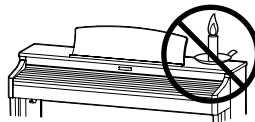

Doing so may cause the illumination to fall over, resulting in fire.

**Ensure that the ventilation is not impeded by covering the ventilation openings with items, such as newspaper, table-cloths, curtains, etc.**

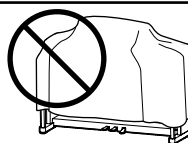

Failure to do so may over-heat the product, resulting in fire.

**The product should be located so that its location or position does not interfere with its proper ventilation. Ensure a minimum distance of 5cm around the product for sufficient ventilation.**

**The product should be serviced by qualified service personnel when:**

- The power supply cord or the plug has been damaged.
- Objects have fallen, or liquid has been spilled into the product.
- The product has been exposed to rain.
- The product does not appear to operate normally or exhibits a marked change in performance.
- The product has been dropped, or the enclosure damaged.

**Notes on Repair**

Should an abnormality occur in the product, immediately turn the power OFF, disconnect the power cord plug, and then contact the shop from which the product was purchased.

**CAUTION:**

To prevent electric shock, match wide blade of plug to wide slot, fully insert.

**ATTENTION:**

Pour éviter les chocs électriques, introduire la lame la plus large de la fiche dans la borne correspondante de la prise et pousser jusqu'au fond.



**An information on Disposal for users**

If your product is marked with this recycling symbol it means that, at the end of its life, you must dispose of it separately by taking it to an appropriate collection point.

You should not mix it with general household waste. Disposing of this product correctly will prevent potential negative effects on the environment and human health which could otherwise arise due to inappropriate waste handling.

For further details, please contact your local authority.

(European Union only)

**Instruction for AC power cord (U.K.)**

**IMPORTANT**

THE WIRES IN THIS MAINS LEAD ARE COLOURED IN ACCORDANCE WITH THE FOLLOWING CODE.

- BLUE : NEUTRAL
- BROWN : LIVE

As the colours of the wires in the mains lead of this apparatus may not correspond with the coloured markings identifying the terminals in your plug, proceed as follows:

The wire which is coloured BLUE must be connected to the terminal which is marked with the letter N or coloured BLACK.

The wire which is coloured BROWN must be connected to the terminal which is marked with the letter L or coloured RED.

Do not plug either terminal of the power cord to the the ground od AC outlet on the wall.

**FCC Information (U.S.A)**

**CAUTION :** Changes or modifications not expressly approved by the party responsible for compliance could void the user's authority to operate the equipment.

**NOTE :** This equipment has been tested and found to comply with the limits for a Class B digital device, pursuant to Part 15 of the FCC Rules. These limits are designed to provide reasonable protection against harmful interference in a residential installation. This equipment generates, uses and can radiate radio frequency energy and, if not installed and used in accordance with the instructions, may cause harmful interference to radio communications. However, there is no guarantee that interference will not occur in a particular installation. If this equipment does cause harmful interference to radio or television reception, which can be determined by turning the equipment off and on, the user is encouraged to try to correct the interference by one or more of the following measures:

- Reorient or relocate the receiving antenna.
- Increase the separation between the equipment and receiver.
- Connect the equipment into an outlet on a circuit different from that to which the receiver is connected.
- Consult the dealer or an experienced radio/TV technician for help.

**Declaration of Conformity**

Products :	Electronic Piano
Model Number :	NV10S/NV5S
Responsible Party Name :	Kawai America Corporation
Address :	2055 East University Drive Rancho Dominguez, CA 90220
Telephone :	310-631-1771

This device complies with Part 15 of the FCC Rules.

Operation is subject to the following two conditions:

- (1) this device may not cause harmful interference, and
- (2) this device must accept any interference received, including interference that may cause undesired operation.

The nameplate label is located on the underside of the instrument, as indicated below.

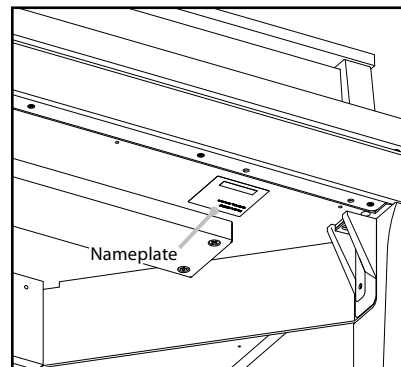

This applies only to products distributed by Kawai America Corporation.

# Introduction

**Thank you for purchasing this Kawai Novus NV10S/NV5S hybrid piano.**

This owner's manual contains important information regarding the instrument's usage and operation. Please read all sections carefully, keeping this manual handy for future reference.

## ■ About this owner's manual

---

- This owner's manual provides information for customers to enjoy using this instrument immediately after purchase, and explanations about the various functions of this instrument.
- Display illustrations shown in this manual may differ from the actual displays of the product depending on its version.

## ■ Nameplate

---

The model name and serial number of the product are indicated on the nameplate label located on the underside of the instrument.

## ■ Cleaning

---

- Make sure to unplug the power cord before cleaning.
- Clean the product body with a dry, soft cloth.
- If the surface of the pedals becomes dirty, clean the pedals using a dry dish-washing sponge.
- Do not attempt to clean the pedals using rust-removing solvents, abrasives or files.
- Do not clean the product using benzene or thinner which may cause discoloring or deformation.

## ■ Intellectual property rights

---

- "Windows" is a registered trademark of Microsoft Corporation.
- "Mac" is a registered trademark of Apple Inc.
- Some samples © PREMIER Engineering Inc.
- The Bluetooth® word mark and logos are registered trademarks owned by the Bluetooth SIG, Inc. and any use of such marks by Kawai Musical Instruments Mfg. Co., Ltd. is under license.
- Qualcomm aptX is a product of Qualcomm Technologies, Inc. and/or its subsidiaries.  
Qualcomm is a trademark of Qualcomm Incorporated, registered in the United States and other countries.  
aptX is a trademark of Qualcomm Technologies International, Ltd., registered in the United States and other countries.



Qualcomm® aptX™

- Other company names and product names mentioned or referenced herein are registered trademarks or trademarks of respective owners.
- Kawai Musical Instruments Mfg. Co., Ltd. shall have no liability for any acts in violation of the Copyright Act made by any users of this product.

## ■ About tuning

---

This piano is a digital instrument and does not require tuning.

If any aspect of this instrument does not function or perform as expected, please contact the store from where the instrument was purchased to seek assistance.

# Table of Contents

## Important Information

Important Safety Instructions .....	2
Introduction .....	7
Table of Contents .....	8
Part Names and Functions .....	10

## Preparation

Opening/Closing the Key Cover .....	12
Using the Music Rest .....	12
Turning on the Power .....	13
Adjusting the Volume .....	14
Using Headphones .....	14
Using Pedals .....	15
Part Names and Functions .....	16
1. Home screen structure .....	16
2. Touchscreen Operations .....	17

## Basic Operation

Piano Tab .....	18
1. Piano tab home screen overview .....	18
2. Piano Editor window .....	20
(1) Piano Variation .....	20
(2) Virtual Technician .....	22
(3) Ambience .....	23
(4) Reverb .....	24
(5) Tuning .....	25
(6) Transpose .....	25
(7) Favorite .....	25
(8) Menu .....	25
Sound Tab .....	26
1. Sound tab home screen overview .....	26
2. Sound Editor .....	28
(1) Main Sound .....	28
(2) Sub Sound .....	29
(3) Virtual Technician (Piano sounds only) .....	31
(4) Reverb .....	31

(5) Effect .....	32
(6) Tuning .....	34
(7) Transpose .....	34
(8) Other sound settings .....	34
(9) Favorite .....	34
(10) Menu .....	35

## Music Tab .....

1. Music tab home screen overview .....	36
2. Player screen overview .....	38
3. Player screen functions .....	40
(1) Player .....	40
(2) Lesson .....	40
(3) Concert Magic .....	42

## Using the Metronome .....

## Recorder .....

(1) Recording .....	48
(2) Recorder menu .....	52

## Adjustments & Settings

### Virtual Technician .....

(1) Touch Curve .....	55
(2) Voicing .....	56
(3) Resonance Depth .....	56
(4) Damper Resonance .....	57
(5) Damper Noise .....	57
(6) String Resonance .....	57
(7) Undamped String Resonance .....	58
(8) Cabinet Resonance .....	59
(9) Key-off Effect .....	59
(10) Fall-Back Noise .....	59
(11) Hammer Noise .....	60
(12) Hammer Delay .....	60
(13) Topboard .....	60
(14) Decay Time .....	61
(15) Release Time .....	61
(16) Minimum Touch .....	61
(17) Stretch Tuning .....	61
(18) Temperament .....	62



(19) Temperament Key .....	63
(20) Key Volume .....	63
(21) Half-Pedal Adjust .....	63
(22) Soft Pedal Depth .....	64
(23) Damper Hold .....	64
<b>Settings Menu</b> .....	65
1. Speaker/Headphone .....	65
(1) Tone Control .....	65
(2) Wall EQ (NV5S only) .....	66
(3) Low Volume Balance .....	66
(4) Speaker Volume .....	66
(5) Spatial Headphone Sound .....	67
(6) Headphone Type .....	67
(7) Headphone Volume .....	67
(8) Line In Volume .....	68
2. 4 Hands Mode .....	69
3. Bluetooth .....	70
(1) Bluetooth MIDI .....	70
(2) Bluetooth MIDI Device Name .....	70
(3) Bluetooth Audio .....	71
(4) Bluetooth Audio Volume .....	71
4. USB Memory .....	72
5. MIDI .....	72
6. User Data .....	72
(1) Sounds   Favorite .....	72
(2) Sounds   Recently Played .....	72
(3) Sounds   User .....	72
(4) Music   Favorite .....	72
(5) Music   Recently Played .....	72
(6) Music   Recorder .....	72
(7) Factory Reset .....	72
7. System .....	73
(1) LCD Brightness .....	73
(2) Display Scale .....	73
(3) Auto Display Off .....	73
(4) Auto Power Off .....	73
(5) Startup Screen .....	74
(6) Startup Settings .....	74

(7) Language .....	74
(8) Information .....	74

## Appendix

<b>Troubleshooting</b> .....	76
<b>Sound List</b> .....	79
<b>Drum Rhythm List</b> .....	80
<b>Sound Demo Song List</b> .....	81
<b>Connecting to Other Devices</b> .....	82
Jack Panel and Headphone Panel (NV10S) / Jack/Control Box (NV5S) .....	83
<b>USB MIDI (USB to Host Connector)</b> .....	84
<b>Information about Bluetooth®</b> .....	85
<b>Assembly Instructions (NV10S only)</b> .....	86
<b>EU Declaration of Conformity</b> .....	91
<b>Specifications</b> .....	92

# Part Names and Functions

## [ NV10S ]

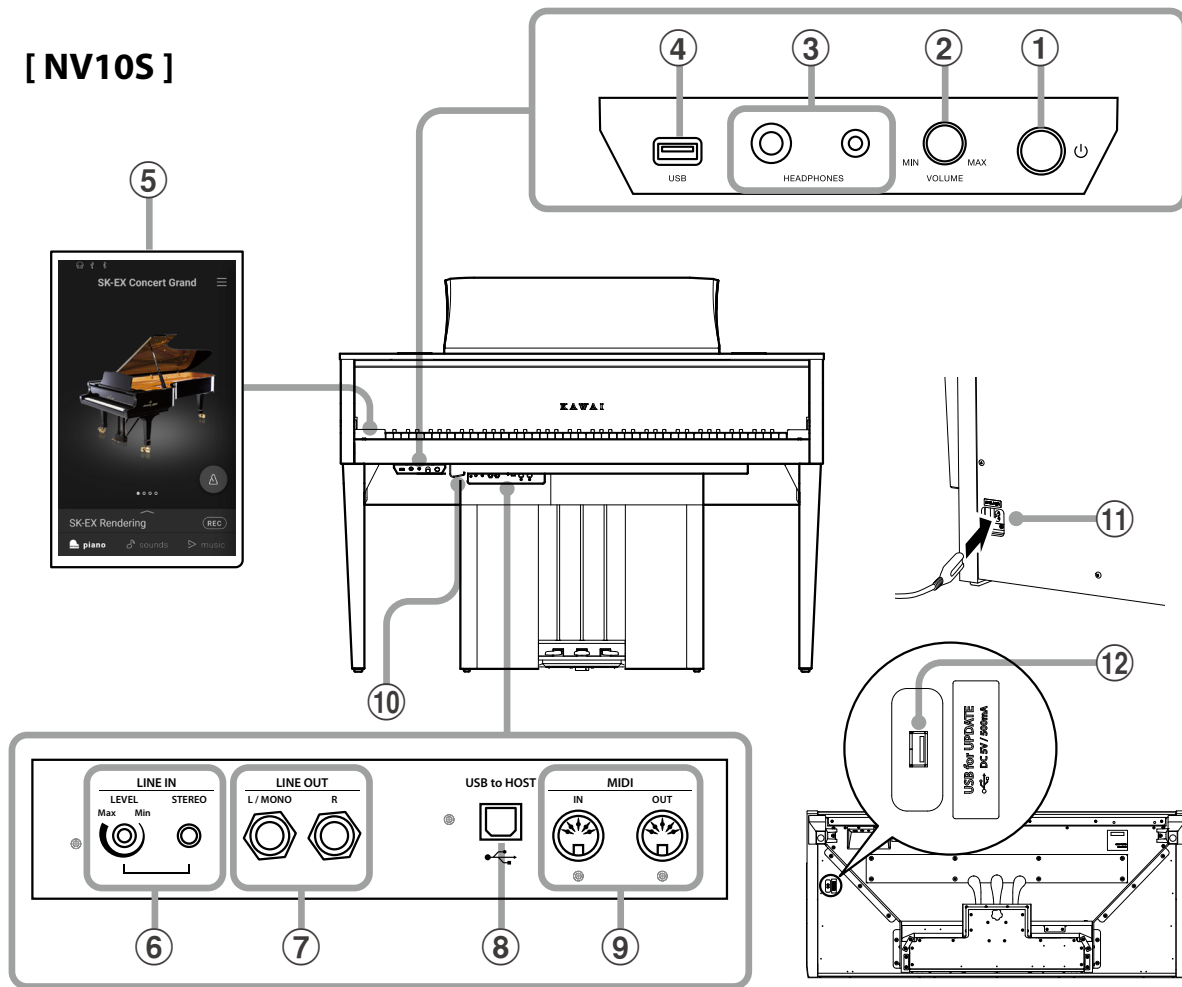

## [ NV5S ]

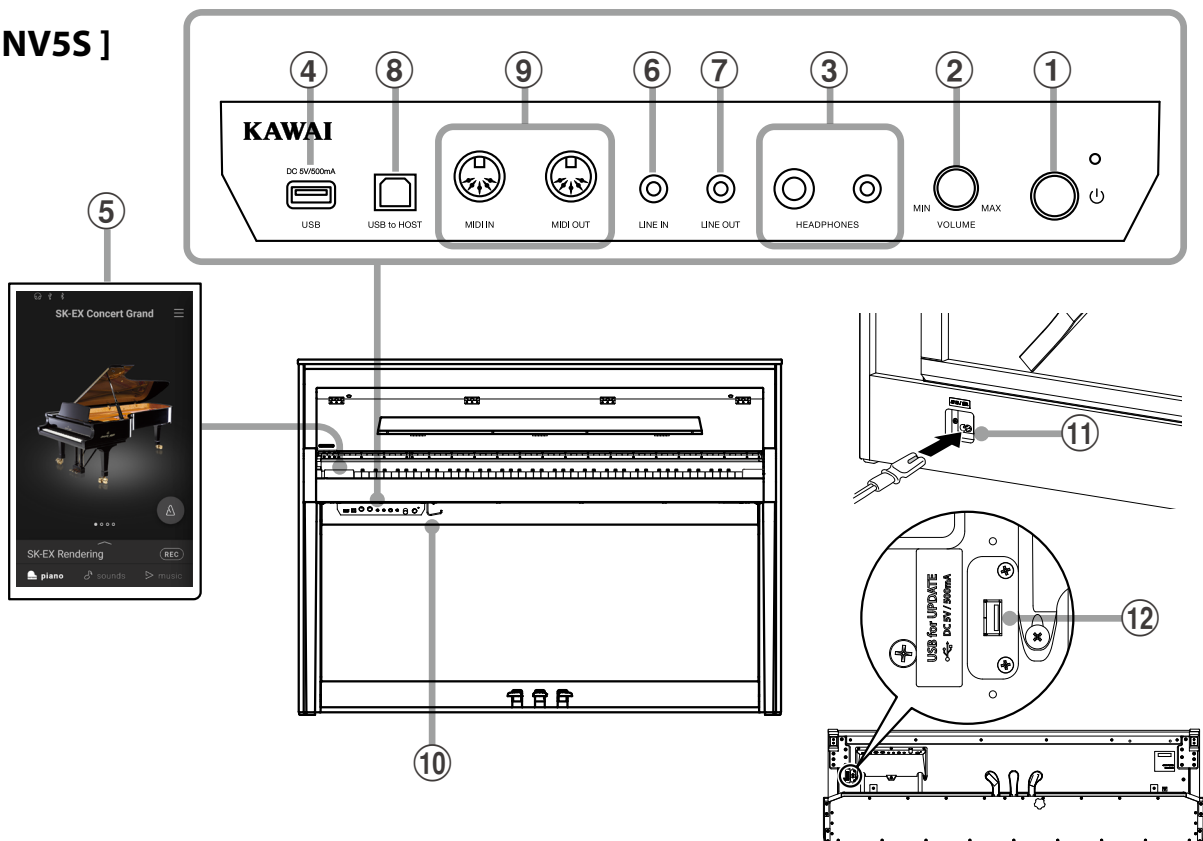

**① POWER button**

This button is used to turn the instrument on/off.

**② MASTER VOLUME knob**

This knob controls the master volume level of the instrument's built-in speakers or headphones, if connected.

**☑ CHECK**

The MASTER VOLUME knob will also affect the volume level of the LINE OUT connectors.

**③ PHONES jacks**

These jacks are used to connect stereo headphones to the NV10S/NV5S hybrid piano.

1/4" and 1/8" connectors are provided for convenience, and both can be used simultaneously, allowing two pairs of headphones to be connected at the same time.

**④ USB to DEVICE port**

This port is used to connect a USB memory device to the instrument.

**⑤ TOUCHSCREEN display**

The touchscreen display provides useful information such as the currently selected mode, sound name, settings values, and the status of various functions. The touchscreen is also used to interact with the instrument by gently tapping on buttons and icons that appear, or by swiping left and right, or up and down.

**☑ CHECK**

- A protective plastic film is attached to the display during production. Please remove this film before attempting to play the instrument.
- The display can be set to turn off automatically after a period of inactivity.

**Ref.** "Auto Display Off" P. 73.

**⑥ LINE IN STEREO jack**

This jack is used to connect the 1/8" stereo output from smart phones, tablets, computers, or other electronic audio equipment to the NV10S/NV5S hybrid piano's amplifier and speakers.

The input level can be adjusted by using the LEVEL knob (NV10S only).

**⑦ LINE OUT STEREO jack**

These jacks are used to connect the stereo output (Left/Right 1/4" phone plug for NV10S, Stereo mini 1/8" phone plug for NV5S) of the NV10S/NV5S hybrid piano to external amplifiers, mixers, recording devices, and similar equipment.

**⑧ USB to HOST port**

This port is used to connect the NV10S/NV5S hybrid piano to a computer using a USB "B to A" type cable in order to send and receive MIDI data.

**⑨ MIDI IN / OUT jacks**

These jacks are used to connect the NV10S/NV5S hybrid piano to external MIDI devices such as other musical instruments or a computer in order to send and receive MIDI data.

**Ref.** "Connecting to Other Devices" P. 82.

**⑩ Headphone hook**

This hook can be used to hang headphones when not in use.

**⑪ AC IN socket**

This socket is used to connect the power cable.

**⑫ USB for UPDATE port**

This port is used to connect a USB memory device to the touchscreen display in order to update the touchscreen software.

# Opening/Closing the Key Cover

## Opening the key cover

Gently lift the key cover with both hands.

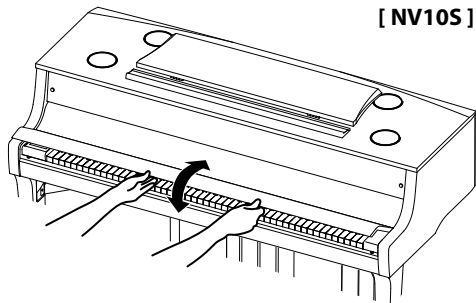

## Closing the key cover

To close the key cover, slowly push or pull it forwards. The Soft Fall system will gently lower the key cover naturally.

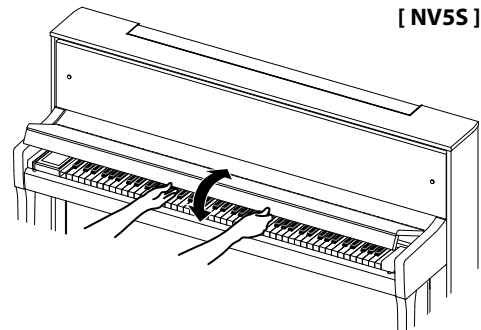

- When opening the key cover, ensure that there are no items placed on top of the key cover. If any items placed on top of the key cover fall inside the instrument, it may cause an electric shock, short circuit, fire or failure of the instrument.
- Be careful to ensure that hands or fingers do not get caught between the key cover and the instrument.
- For the NV5S, ensure that the music rest is folded-up before closing the key cover. If the key cover is closed while the music rest is folded down, the music rest and/or keyboard may be damaged.
- The key cover is designed to close slowly using the Soft Fall mechanism. However, the Soft Fall mechanism may not work effectively if the key cover is only partially opened. Therefore, when opening the key cover, be careful not to release your hands from the key cover until fully open.

# Using the Music Rest

## [ NV10S ]

### Setting up the music rest

Lift the music rest, then lower the metal prop (rear side) into the recessed holder to set the desired music rest angle. (The music rest can be set to one of six different angle positions.)

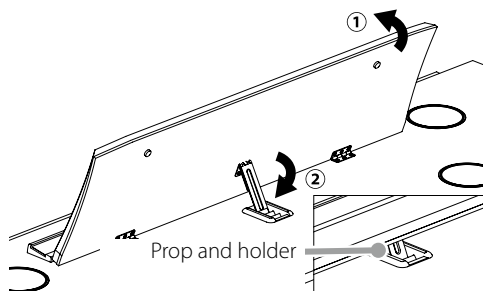

### Folding down the music rest

To lower the music rest, gently lift the prop from the recessed holder, then lower the music rest.

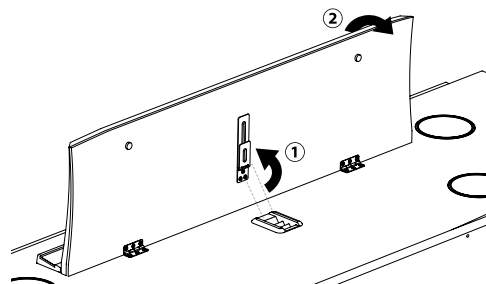

## [ NV5S ]

Gently fold down the music rest into position.

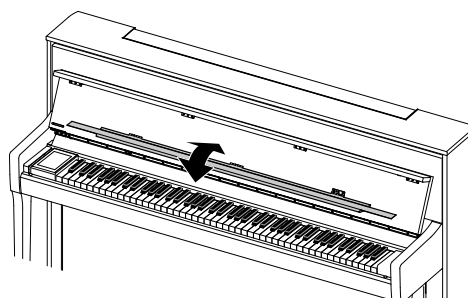

# Turning on the Power

## 1. Connecting the power cable to the instrument

Connect the included power cable to the "AC IN" socket located on the back side of the instrument, in the bottom left corner.

[ NV10S ]

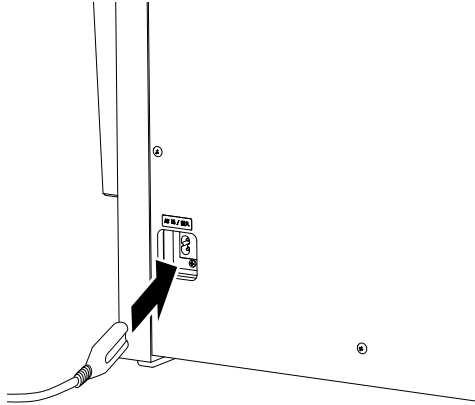

[ NV5S ]

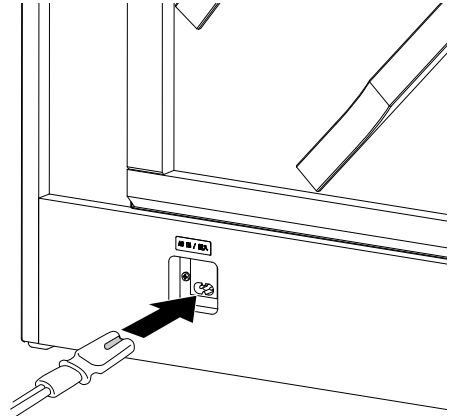

## 2. Connecting the power cable to an outlet

Connect the instrument's power cable to an AC outlet.

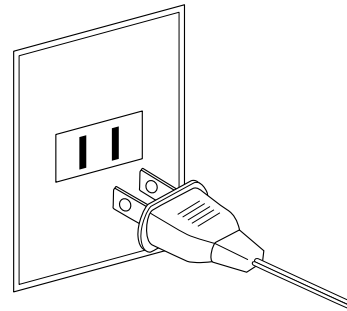

## 3. Turning on the power

Press the POWER button located on the right hand side of the instrument.

The instrument will turn on and the KAWAI logo will appear in the touchscreen display. After a short period, the Piano screen will appear, indicating that the instrument is ready to be played.

To turn off the power, press and hold the POWER button again for 1~2 seconds.



**Do not turn the power off until the startup process is completed.**

[ NV10S ]

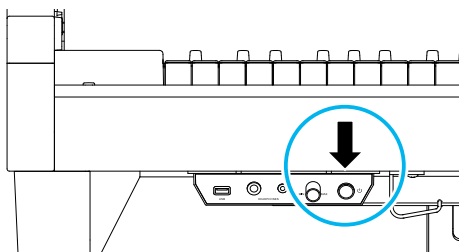

[ NV5S ]

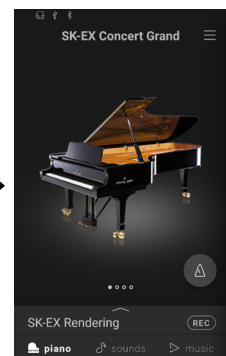
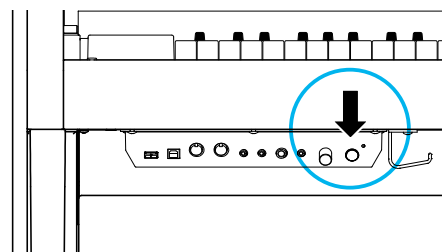

# Adjusting the Volume

The MASTER VOLUME knob controls the volume level of the instrument's speakers, or headphones if connected.

Turn the knob clockwise to increase the volume, and anti-clockwise to decrease the volume.

Use this knob to set the volume to a comfortable listening level - the middle is often a good starting point.

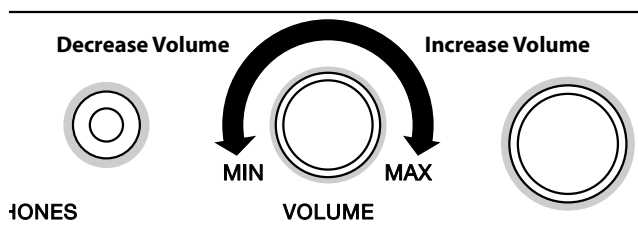

## CHECK

- The MASTER VOLUME knob will also affect the volume level of the LINE OUT connectors.
- The maximum volume level of the speakers can be reduced by using the "Speaker Volume" setting.

Ref. "Speaker Volume" P. 66.

# Using Headphones

## Using headphones

Use the jacks located beneath the keyboard on the left hand side to connect stereo headphones to the NV10S/NV5S hybrid piano. 1/4" and 1/8" connectors are provided for convenience.

Two pairs of headphones can be connected and used simultaneously.

[ NV10S ]

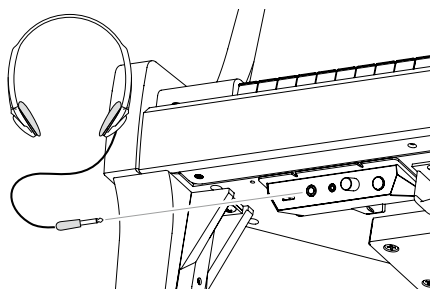

[ NV5S ]

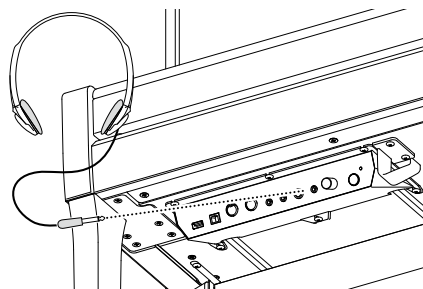

## Checking the connection of the headphones

The headphones icon will appear in the status bar of the touchscreen display.

Headphones icon



## Attaching the headphone hook (optional)

A headphone hook is included with the NV10S/NV5S hybrid piano and can be used to hang headphones when not in use. If desired, attach the headphone hook to the underside of the keyboard as shown in the illustration.



**Do not attempt to place heavy items onto the headphone hook. Doing so may damage the headphone hook.**

[ NV10S ]

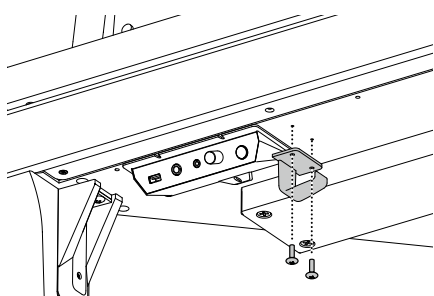

[ NV5S ]

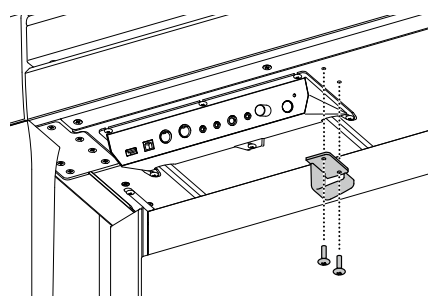

# Using Pedals

As with a grand piano, the NV10S/NV5S hybrid piano features three pedals: damper, sostenuto, and soft.

## ■ Damper pedal (right pedal)

Depressing this pedal sustains the sound after one's hands have been lifted from the keyboard – greatly enriching the piano sound, while also assisting smooth “legato” passages.

The damper pedal is capable of responding to half pedaling.

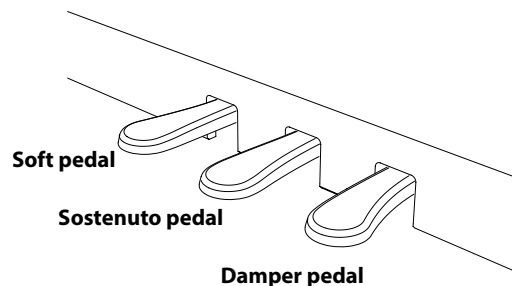

## ■ Soft pedal (left pedal)

Depressing this pedal softens the sound, reducing its volume. The soft pedal of NV10S only is also capable of responding to half pedaling.

When the rotary speaker effect is selected, the soft pedal is also used to alternate the speed of the rotary simulation between “Slow” and “Fast” effect modes.

## ■ Sostenuto pedal (centre pedal)

Depressing this pedal after playing the keyboard and before releasing the keys, sustains the sound of only those notes that have been played. Any keys that are subsequently played after the sostenuto pedal is depressed will not be sustained.

## ■ Pedal support bolt

A pedal support bolt is attached to the base of the pedal board to aid stability when the pedals are pushed.

Turn the bolt anti-clockwise until it makes contact with the floor and supports the pedals firmly. If the pedal support bolt does not make proper contact with the floor, the pedal board may become damaged.

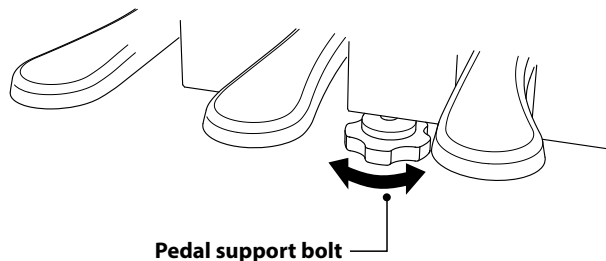

**When moving the instrument, always adjust or remove the pedal support bolt, then readjust when the instrument is in its new position.**

## ■ Caring for the pedals

If the surface of the pedals becomes dirty, clean the pedals using a dry dish-washing sponge. Do not attempt to clean the pedals using rust-removing solvents, abrasives or files.

## ■ Grand Pedal System

The NV10S/NV5S hybrid piano features the Grand Pedal System, which replicates the position and individual weighting of the damper, soft, and sostenuto pedals of a Shigeru Kawai SK Concert Grand piano. It is also possible to adjust the sensitivity of the damper pedal, and the effectiveness of the soft pedal using the “Half-Pedal Adjust” and “Soft Pedal Depth” settings.

Ref. “Half-Pedal Adjust” P. 63  
“Soft Pedal Depth” P. 64.

# Part Names and Functions



## 1. Home screen structure

The NV10S/NV5S hybrid piano's user interface is arranged into three different "home" screens, which are selected by tapping the corresponding Piano, Sound, and Music tabs shown at the bottom of the touchscreen display.

Functions that are common to each home screen are explained below.

### Status bar

This area indicates the status of connected devices (headphones, USB, Bluetooth), and important functions (transpose, effects, reverb).

Icon	Description
 (Headphones icon)	This icon is displayed when headphones are connected.
 (USB icon)	This icon is displayed when a USB memory device is connected to the [USB to DEVICE] port.
 (Bluetooth icon)	This icon is displayed when the Bluetooth MIDI or Bluetooth Audio functions are turned on.

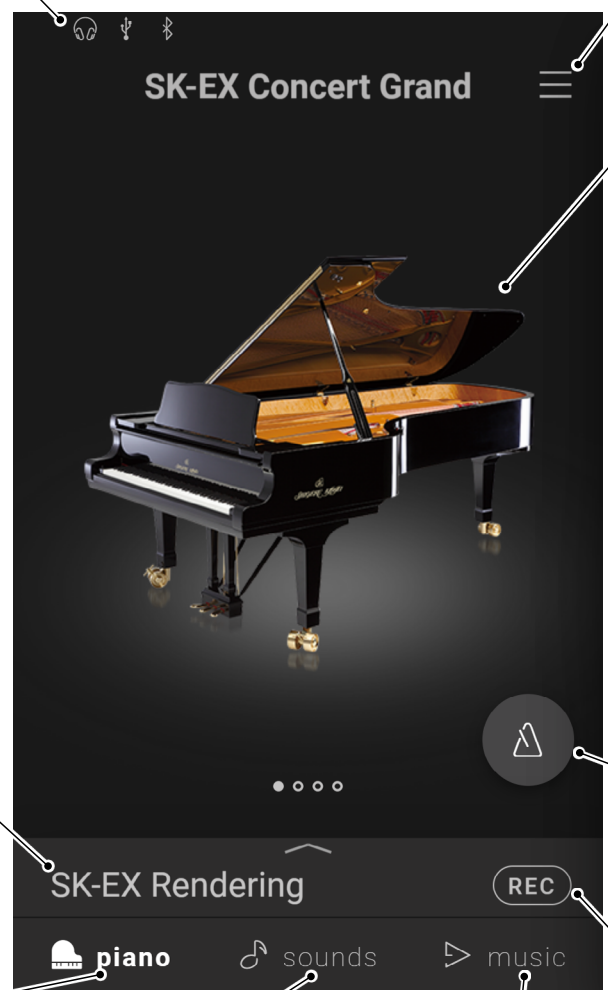

### Selection bar

This area displays the name of the currently selected sound/variation or piece of music.

Tap this area to display information about the current sound/piece of music, make adjustments, or show additional options.

### Piano tab Ref. P. 18

This tab is used to access all of the available acoustic piano sounds.

This tab is recommend for acoustic piano performance.

### Sound tab Ref. P. 26

This tab is used to access all of the available sounds, including acoustic pianos, electric pianos, organs, strings, etc.

This tab also allows two sounds to be played simultaneously, and for additional effects to be applied.

### Music tab Ref. P. 36

This tab is used to access a wide range of music built into the instrument.

This tab is also used to play music stored on a USB memory device, or recorded to the internal memory.



## Menu button Ref. P. 65

This button is used to display the menu, which provides access to various settings that control the hybrid piano.

## Selection area

This area is used to select the desired sound (Piano tab, Sound tab) or piece of music (Music tab).

## MEMO

The selection area will change depending on the current "home" screen.

By default, the NV10S/NV5S hybrid piano will always start-up with the Piano screen, however this behaviour can be changed via the System settings menu.

Ref. "Startup Screen" P. 74

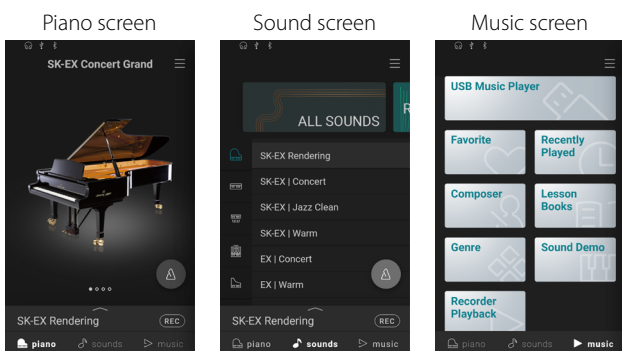

## Metronome button Ref. P. 44

This button is used to start/stop the Metronome, and open the metronome settings window.

 : The Metronome is counting.

 : The Metronome is stopped.

## Recorder button Ref. P. 46

This button is used to change the state of the Recorder.

 (Inactive): The Recorder is not in use.

 (Standby): The Recorder is in standby, and will start by tapping the button again, or pressing a key on the keyboard.

 (Recording): The Recorder is recording.

# 2. Touchscreen Operations

The explanations below outline the different methods of interacting with the touchscreen, and how these operations are referenced in this owner's manual.

## Tap



Touch an area of the screen (e.g. an icon or button) and release it immediately.

In this owner's manual, this operation is indicated by:



## Swipe

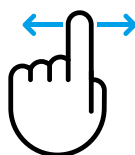

Touch and hold an area of the screen, slide your finger left or right, then release.

In this owner's manual, this operation is indicated by:



## Scroll

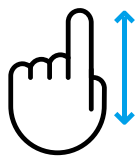

Touch and hold an area of the screen, slide your finger up or down, then release.

In this owner's manual, this operation is indicated by:



## Drag

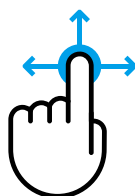

Touch and hold an icon or button, slide your finger to another position, then release.

In this owner's manual, this operation is indicated by:



## 1. Piano tab home screen overview

### Piano Selection area

The name and picture of the currently selected piano is shown in this area. The piano can be changed by swiping left and right.

Piano name	Characteristics
SK-EX Concert Grand	A concert grand piano with a clear tonal color and rich powerful bass.
EX Concert Grand	A concert grand piano with an elegant detailed tone and exceptionally broad dynamic range.
SK-5 Grand Piano	A medium-sized grand piano with a polished brilliant tone.
Upright Piano	A full-bodied traditional upright piano.

### Selection bar

This area displays the name of the currently selected piano sound. Tap this bar to open the Piano Editor window, which allows various aspects of the sound to be adjusted.

#### ■ Piano Editor window

The Piano Editor window allows various aspects of the sound to be adjusted.

Function	Description	Ref.
Piano Variation	Change the sound variation of the current piano.	P. 20
Virtual Technician	Change the overall tonal character of the current piano sound, or adjust the various parameters individually.	P. 22
Ambience (SK-EX Rendering only)	Adjust the type and amount of ambience applied to the current sound, in order to simulate various different virtual environments.	P. 23
Reverb (All except SK-EX Rendering)	Adjust the type and amount of reverb applied to the current sound, in order to simulate various different virtual environments.	P. 24
Tuning	Adjust the overall pitch of the current sound in 0.5 Hz steps. This setting may be useful when playing with other instruments/sound sources.	P. 25
Transpose	Adjust the overall pitch of the current sound in semi-tone steps. This setting may be useful when playing with other instruments tuned for different keys.	P. 25
Menu area	Store the current sound to memory, or display the Metronome and Recorder functions.	P. 25

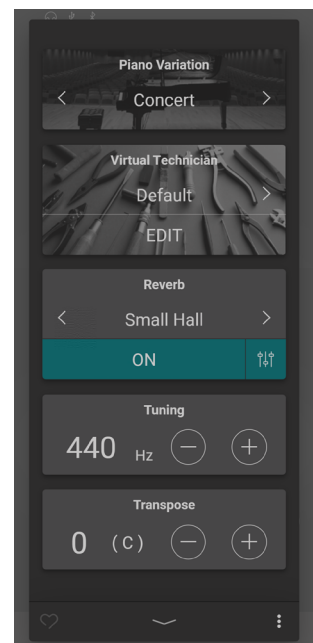

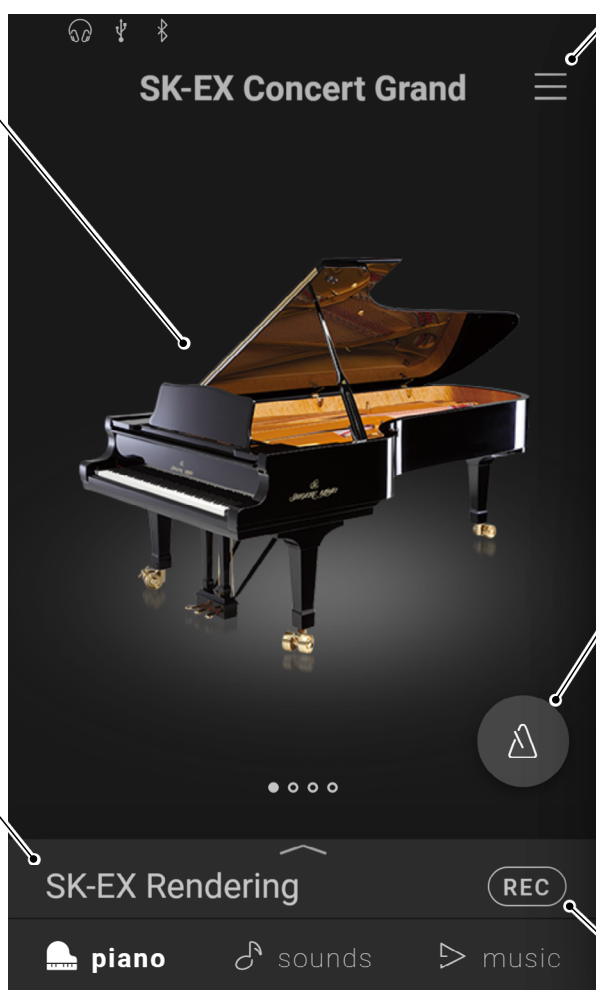



### Menu button Ref. P. 65

This button is used to display the menu, which provides access to various settings that control the hybrid piano.



### Metronome button Ref. P. 44

This button is used to start/stop the Metronome, and open the metronome settings window.

-  : The Metronome is counting.
-  : The Metronome is stopped.

### Recorder button Ref. P. 46

This button is used to change the state of the Recorder.

-  (Inactive): The Recorder is not in use.
-  (Standby): The Recorder is in standby, and will start by tapping the button again, or pressing a key on the keyboard.
-  (Recording): The Recorder is recording.

## 2. Piano Editor window



This window allows various aspects of the current piano sound to be adjusted.

Tap the Selection bar on the Piano tab screen to open the Piano Editor window.

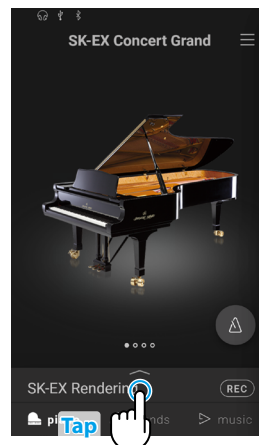
To close the Piano Editor window, tap the  button at the bottom of the window.



### (1) Piano Variation

In the Piano Variation area, tap the   buttons to change the piano sound variation.

#### CHECK

Rendering Type will only be displayed when the “SK-EX Rendering” piano sound variation is selected.

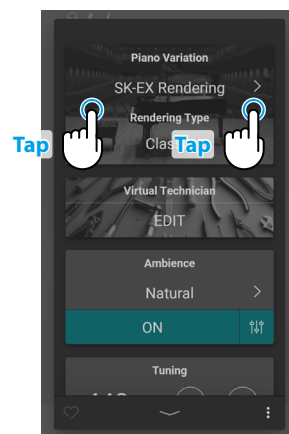
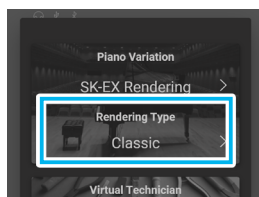

#### ■ SK-EX Concert Grand

Piano Variation	Rendering Type	Description
SK-EX Rendering	Classic	A standard grand piano sound with a broad dynamic range.
	Classic2	A Lustrous and brilliant grand piano sound.
	Romantic	A mellow grand piano sound with soft hammers.
	Full	A big grand piano sound with a strong bass and bright character.
	Jazz	A clean grand piano sound that is suitable for jazz.
	Brilliant	A bright grand piano sound with emphasised treble.
	Rich	A rich grand piano sound with emphasised resonances.
	Ballad	A clear, light grand piano sound that is suitable for ballads.
	Vintage	A soft grand piano sound with a vintage character.
	Boogie	A small grand piano with a detuned character.
Concert	—	A standard grand piano sound with a broad dynamic range.
Jazz Clean	—	A grand piano sound with a thick and clear character.
Warm	—	A soft and warm grand piano sound.

#### MEMO About SK-EX Rendering

The SK-EX Rendering piano sound variation combines high resolution multi-channel sampling with advanced modelling algorithms, reproducing 10 different acoustic piano characters that are suitable for a variety of musical genres.

## ■ EX Concert Grand

Piano Variation	Description
Concert	A luxurious and fluent grand piano sound.
Warm	A soft and warm sound grand piano sound.
Standard	A distinctive and bright grand piano sound.
Pop Grand	A bright and powerful grand piano sound.
Pop Piano	A bright and exciting grand piano sound with a characteristic attack.
New Age	A clear and transparent grand piano sound.
Modern	A transparent grand piano sound that is suitable for performing modern music.

## ■ SK-5 Grand Piano

Piano Variation	Description
Classical	A lustrous grand piano sound that is crisp and distinctive.
Jazz Old School	A thick and vintage grand piano sound.
Pop	A strong and distinctive grand piano sound that is suitable for pop music.

## ■ Upright Piano

Piano Variation	Description
Classical	A deep upright piano sound that produces a feeling of nostalgia.
Boogie	A thick and vintage upright piano sound.
Honky Tonk	A bright upright piano sound with a detuned character.

## (2) Virtual Technician

In the Virtual Technician area, tap the < > buttons to change the Virtual Technician preset.

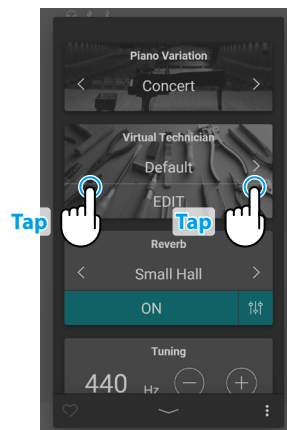

### ✓ CHECK

Virtual Technician presets will not be displayed when the “SK-EX Rendering” piano sound variation is selected.

### ■ Virtual Technician preset

Preset	Description
Default	The default piano sound without additional adjustments.
Noiseless	A piano adjusted to minimise additional damper and string resonances, and mechanism noises.
Deep Resonance	A piano adjusted to emphasise damper and string resonances.
Ligth Resonance	A piano adjusted to reduce damper and string resonances.
Soft	A piano adjusted by softening the hammers and increasing the touch weight of the keyboard in order to produce a softer tone that is suitable for slow, quiet pieces.
Brilliant	A piano adjusted by hardening the hammers in order to produce a brighter tone for modern pieces.
Clean	A piano adjusted by hardening the hammers and reducing the damper and string resonances.
Full	A piano adjusted to emphasise dynamics with a lightened keyboard touch and powerful damper and string resonances.
Dark	A piano adjusted by hardening the hammers and increasing the touch weight of the keyboard, in order to produce a dark, gloomy tone.
Rich	A piano adjusted by lightening the touch weight of the keyboard and increasing damper and string resonances.
Historical	A piano adjusted for romantic, classical music, with a bright, open tone.
User	This preset will be selected automatically after adjusting a Virtual Technician preset using the edit screen.

Tap the [Edit] button to show the Virtual Technician edit screen, allowing various parameters to be adjusted individually.

Ref. “Virtual Technician” P. 54



### (3) Ambience

1. In the Ambience area, tap the [On/Off] buttons to turn Ambience simulation on/off.

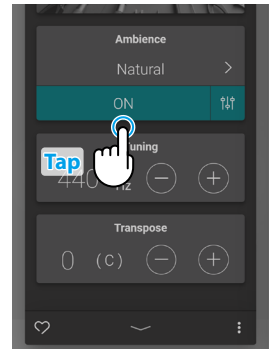

2. In the Ambience area, tap the < > buttons to change the Ambience type.

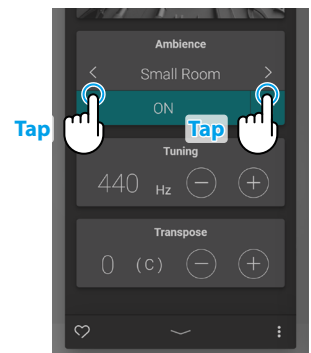

3. In the Ambience area, tap the  $\updownarrow$  button to show additional options for controlling the Depth.

Drag the Depth slider right/left to increase/decrease the depth of the Ambience simulation.

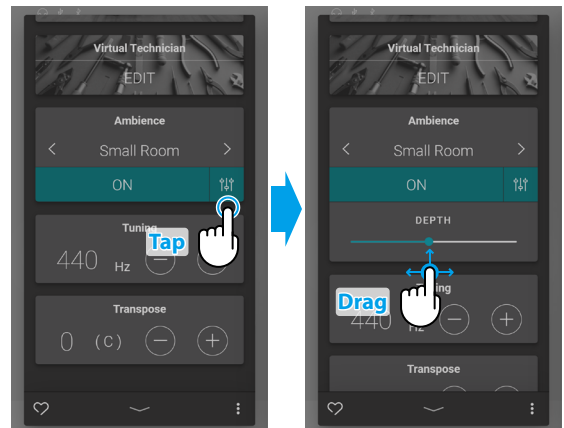

#### ✓ CHECK

Ambience will only be displayed when the "SK-EX Rendering" piano sound variation is selected.

#### ■ Ambience types

Type	Description
Natural	Simulates the ambience of a natural environment.
Small Room	Simulates the ambience/reverberation of a small room.
Medium Room	Simulates the ambience/reverberation of a medium-sized room.
Large Room	Simulates the ambience/reverberation of a large room.
Mellow Lounge	Simulates the ambience/reverberation of a recording studio.
Bright Lounge	Simulates the ambience/reverberation of a wooden recording studio.
Studio	Simulates the soft ambience/reverberation of a lounge.
Wood Studio	Simulates the bright ambience/reverberation of a lounge.
Live Stage	Simulates the ambience/reverberation of a live stage.
Echo	Simulates the ambience/reverberation of an echo chamber.

## (4) Reverb

1. In the Reverb area, tap the [On/Off] buttons to turn Reverb simulation on/off.

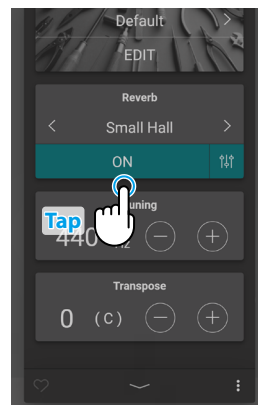

2. In the Reverb area, tap the < > buttons to change the Reverb type.

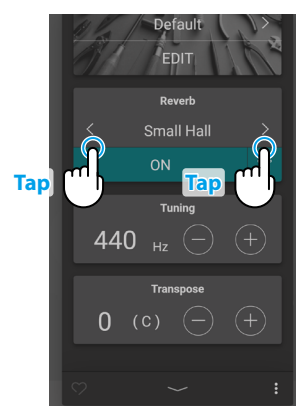

3. In the Reverb area, tap the  $\updownarrow$  button to show additional options for controlling Time and Depth.

Drag the Time slider right/left to increase/decrease the decay length of the Reverb simulation.

Drag the Depth slider right/left to increase/decrease the depth of the Reverb simulation.

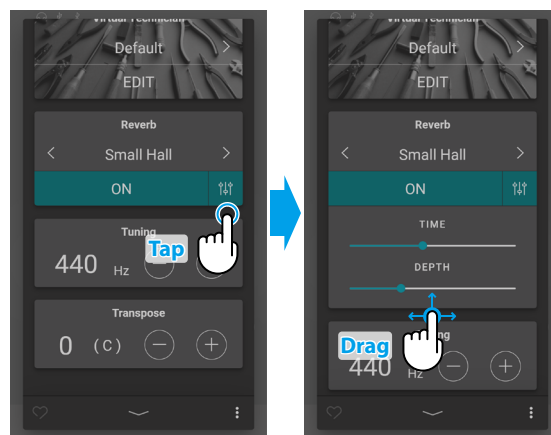

### ✓ CHECK

Reverb will not be displayed when the “SK-EX Rendering” piano sound variation is selected.

### ■ Reverb types

Type	Description
Room	Simulates the ambience of a small rehearsal room.
Lounge	Simulates the ambience of piano lounge.
Small Hall	Simulates the ambience of a small hall.
Concert Hall	Simulates the ambience of a concert hall or theatre.
Live Hall	Simulates the ambience of a live hall or stage.
Cathedral	Simulates the ambience of a large cathedral.



## (5) Tuning

In the Tuning area, tap the [-] and [+] buttons to change the Tuning value.

The Tuning value can be adjusted in 0.5 Hz increments within the range of 427.0~453.0 Hz.

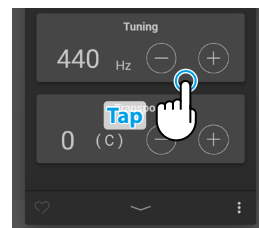

## (6) Transpose

In the Transpose area, tap the [-] and [+] buttons to change the Transpose value.

The Transpose value can be adjusted in semi-tone increments within the range of -12~12.

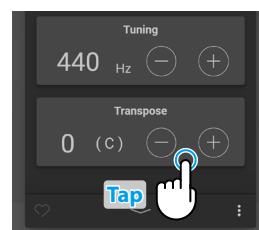

## (7) Favorite

Tap the  button to add the current sound to the Favorites category of the Sound tab.

Tap the  button again to remove the sound from the Favorites category.

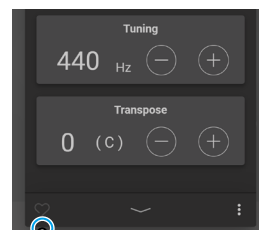

## (8) Menu

Tap the  button to open the menu.

The following options will be displayed:

- **Save this sound**

This option will save the current sound settings as a User Sound to the "User" category of the Sound tab.

Follow the steps according to the dialog that appears in the display.

- **Open Recorder**

This option will display the Recorder screen.

Use this option to display the Recorder screen while the Recorder is stopped.

 Ref. "Recorder screen" P. 47

- **Open Metronome**

This option will display the Metronome screen.

Use this option to display the Metronome screen while the Metronome is stopped.

 Ref. "Using the Metronome" P. 44

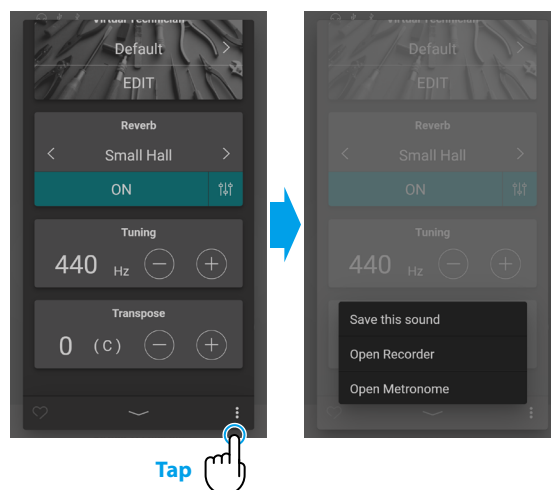

Tap an area outside of the options to close the menu and return to the Editor window.

# Sound Tab

## 1. Sound tab home screen overview

### Category Selection area

The name and picture of the currently selected sound category is shown in this area. The sound category can be changed by swiping left and right.

Category list	Description
All Sounds	All of the sounds available, organised by instrument type.
User	Sounds that have been adjusted and stored using the Piano Editor/Sound Editor.
Favorite	Sounds that have been specified as a Favorite using the Piano Editor/Sound Editor.
Recently Played	Sounds that have been selected previously.
Recommended	Sounds that are recommended by Kawai.
Classic	Sounds that are suitable for playing Classical music.
Jazz	Sounds that are suitable for playing Jazz music.
Pop	Sounds that are suitable for playing Pop music.

### ☑ CHECK

- The “User” and “Favorite” categories will only be displayed if a User sound has been stored or a sound has been specified as a Favorite.
- The “Recently Played” category will only be displayed after selecting a sound.

### Selection bar

This area displays the name of the currently selected sound. Tap this bar to open the Sound Editor window, which allows various aspects of the sound to be adjusted.

### ■ Sound Editor

The Sound Editor window allows various aspects of the sound to be adjusted.

Function	Description	Ref.
Main Sound	Change the instrument type and sound of the Main sound.	P. 28
Sub Sound	Change the status, and then the instrument type and sound of the Sub sound. <b>Split:</b> Split the keyboard into two sections and use the Sub sound for the left section. <b>Dual:</b> Combine the Main sound and Sub sound together.	P. 29
Virtual Technician	Change the overall tonal character of the current piano sound, or adjust the various parameters individually.	P. 31
Reverb	Adjust the type and amount of reverb applied to the current sound, in order to simulate various different virtual environments.	P. 31
Effect	Adjust the type and amount of effects applied to the current sound, in order to simulate various different digital and analogue effects.	P. 32
Tuning	Adjust the overall pitch of the current sound in 0.5 Hz steps. This setting may be useful when playing with other instruments/sound sources.	P. 34
Transpose	Adjust the overall pitch of the current sound in semi-tone steps. This setting may be useful when playing with other instruments tuned for different keys.	P. 34
Other sound settings	Adjust other settings related to the current sound.	P. 34
Menu	Store the current sound to memory, or display the Metronome and Recorder functions.	P. 35

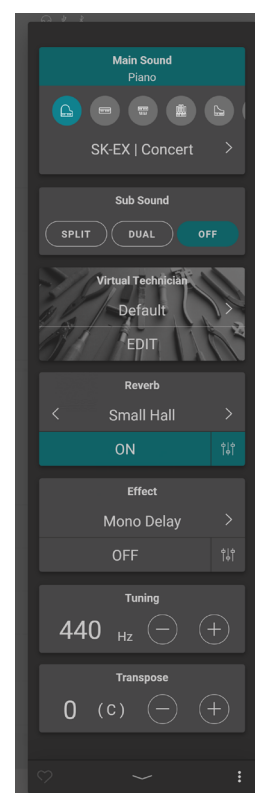

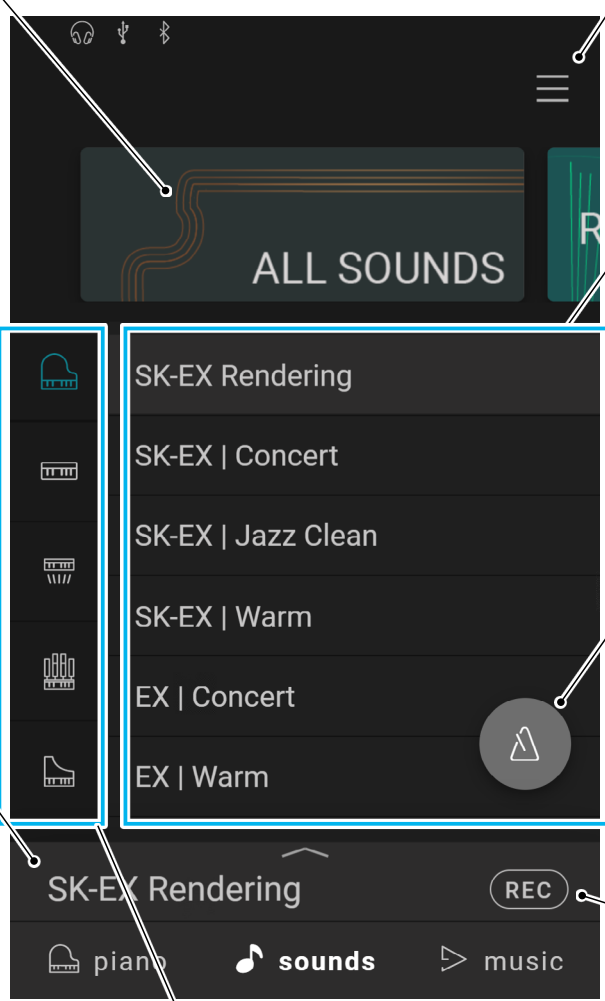

**Menu button** Ref. **P. 65**



This button is used to display the menu, which provides access to various settings that control the hybrid piano.

**Sound list** Ref. **P. 79**

This area lists the available sounds in each category. Swipe up/down to scroll through the list, then tap the desired sound to select it.



**Metronome button** Ref. **P. 44**

This button is used to start/stop the Metronome, and open the metronome settings window.

-  : The Metronome is counting.
-  : The Metronome is stopped.

**Recorder button** Ref. **P. 46**

This button is used to change the state of the Recorder.

-  (Inactive): The Recorder is not in use.
-  (Standby): The Recorder is in standby, and will start by tapping the button again, or pressing a key on the keyboard.
-  (Recording): The Recorder is recording.

**Instrument type ("All Sounds" category only)**

When the "All Sounds" category is selected, this area lists the available instrument types (piano, organ, strings, etc.).  
Swipe up/down to scroll through the list, then tap the desired instrument type to select it.

## 2. Sound Editor

This window allows various aspects of the current sound to be adjusted.

Tap the Selection bar on the Sound tab screen to open the Sound Editor window.

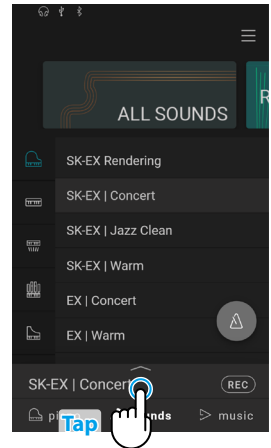

To close the Sound Editor window, tap the  button at the bottom of the window.

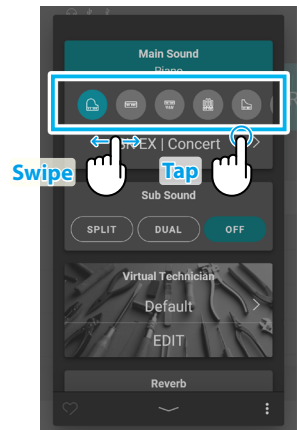

### (1) Main Sound

1. In the Main Sound area, swipe the icons left/right to scroll through the available instrument types, then tap the desired icon to select it.



2. Tap the   buttons to change the selected sound.

 Ref. "Sound List" P. 79

### CHECK

- If "Split" is selected in the Sub Sound area, the Main Sound will be used for the right section of the keyboard.
- Dual mode and Split mode will not be displayed when the "SK-EX Rendering" piano sound variation is selected.



## (2) Sub Sound

The Sub Sound area is used to enable/disable the "Split" and "Dual" playing modes, and change the instrument type and sound of the Sub Sound.

### ■ Dual mode

The Dual playing mode allows two sounds to be layered together, creating a more complex sound. For example, a piano sound layered with strings, or a church organ combined with a choir, etc.

1. In the Sub Sound area, tap the [Dual] button to enable Dual playing mode.

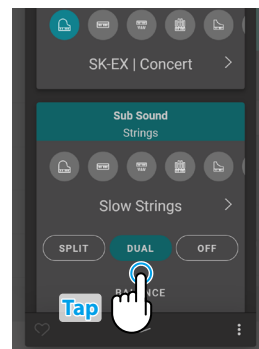

2. In the Sub Sound area, swipe the icons left/right to scroll through the available instrument types, then tap the desired icon to select it.

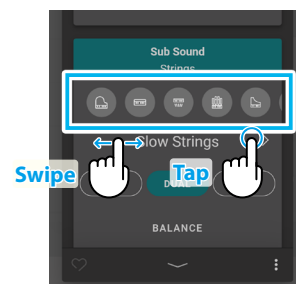

3. Tap the < > buttons to change the selected sound.

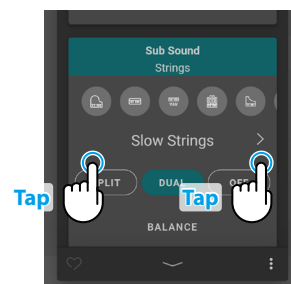

When Dual playing mode is selected, the following settings will be displayed.

#### • Balance

This setting is used to adjust the volume balance between the Main and Sub sounds. Drag the Balance slider right/left to increase the volume of the Main/Sub sounds.

#### • Octave Shift

This setting is used to lower/raise the pitch of the Sub sound in octave steps. Tap the [-] and [+] buttons to change the Octave Shift value. The Octave Shift value can be adjusted within the range of -2~2.

#### • Dynamics

This setting is used to adjust the dynamic sensitivity of the Sub sound relative to the Main sound. Drag the Dynamics slider right/left to increase/increase the dynamic sensitivity of the Sub sound.

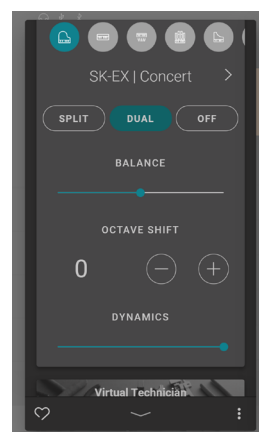

# Sound Tab

## ■ Split mode

The Split playing mode divides the keyboard into two sections, allowing each section to be played with a different sound. For example, a bass sound in the left section, and a piano sound in the right section.

1. In the Sub Sound area, tap the [Split] button to enable Split playing mode.

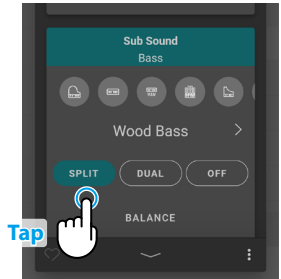

2. In the Sub Sound area, swipe the icons left/right to scroll through the available instrument types, then tap the desired icon to select it.

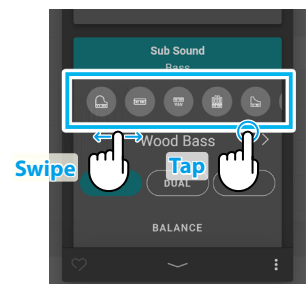

3. Tap the < > buttons to change the selected sound.

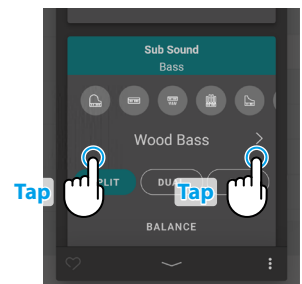

When Split playing mode is selected, the following settings will be displayed.

- **Balance**

This setting is used to adjust the volume balance between the Main (right section) and Sub (left section) sounds.

Drag the Balance slider right/left to increase the volume of the Main/Sub sounds.

- **Split Point**

This setting is used to set the point on the keyboard that divides the Main (right section) and Sub (left section) sounds.

Tap the [-] and [+] buttons to change the Split Point.

- **Octave Shift**

This setting is used to lower/raise the pitch of the Sub sound in octave steps.

Tap the [-] and [+] buttons to change the Octave Shift value.

The Octave Shift value can be adjusted within the range of 0~+3.

- **Lower Pedal**

This setting is used to enable/disable pedal functions for the Sub (left section) sound.

When turned off, the pedals will only affect the Main (right section) sound, and not the Sub (left section) sound.

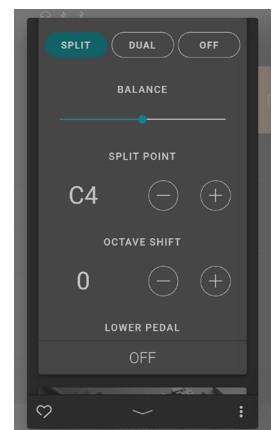

### ☑ CHECK

The pedal functions will always affect the Main (right section) sound.

### (3) Virtual Technician (Piano sounds only)

In the Virtual Technician area, tap the < > buttons to change the Virtual Technician preset.

Tap the [Edit] button to show the Virtual Technician edit screen, allowing various parameters to be adjusted individually.

Ref. "Virtual Technician" P. 54

"Virtual Technician preset" P. 22

### (4) Reverb

1. In the Reverb area, tap the [On/Off] buttons to turn Reverb simulation on/off.

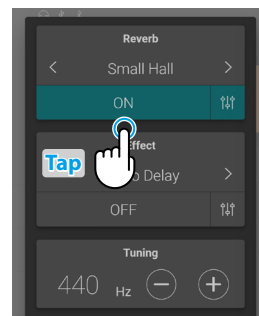

2. In the Reverb area, tap the < > buttons to change the Reverb type.

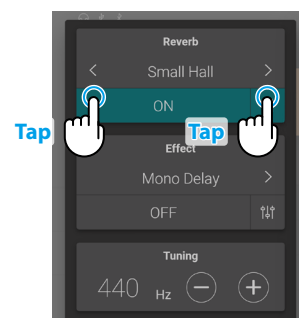

3. In the Reverb area, tap the speaker icon button to show additional options for controlling Time and Depth.

Drag the Time slider right/left to increase/decrease the decay length of the Reverb simulation.

Drag the Depth slider right/left to increase/decrease the depth of the Reverb simulation.

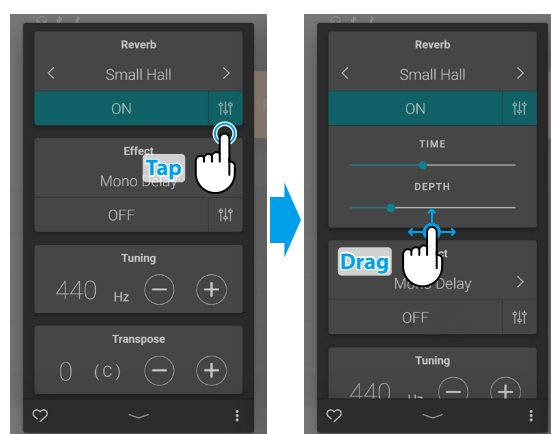

#### ✓ CHECK

Reverb will not be displayed when the "SK-EX Rendering" piano sound variation is selected.

#### ■ Reverb types

Type	Description
Room	Simulates the ambience of a small rehearsal room.
Lounge	Simulates the ambience of piano lounge.
Small Hall	Simulates the ambience of a small hall.
Concert Hall	Simulates the ambience of a concert hall or theatre.
Live Hall	Simulates the ambience of a live hall or stage.
Cathedral	Simulates the ambience of a large cathedral.

## (5) Effect

1. In the Effect area, tap the [On/Off] buttons to turn Effect simulation on/off.

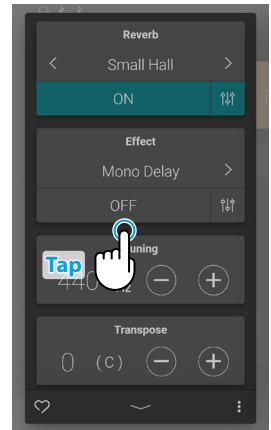

2. In the Reverb area, tap the < > buttons to change the Reverb type.

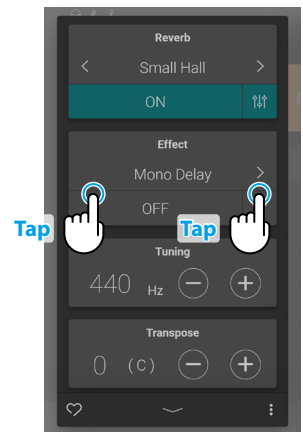

3. In the Effect area, tap the speaker icon button to show additional settings for controlling the selected effect.

Drag the sliders right/left to increase/decrease the value of the setting.

Ref. "Effect parameters" P. 33

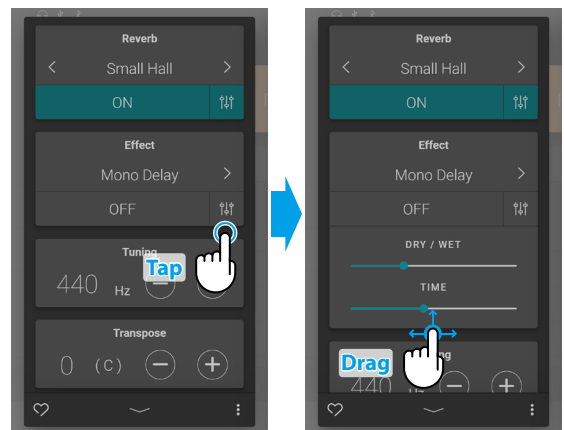



## ■ Effect types

Effect type	Description
Mono Delay	Applies an echo effect to the sound, playing through both speakers simultaneously.
PingPong Delay	Applies a “ping pong” echo effect to the sound, giving the impression that it is “bouncing” from left to right.
Triple Delay	Similar in principle to PingPong Delay, but with an additional centre echo.
Chorus	Layers a slightly detuned version of the sound over the original, thus enriching its tonal character.
Classic Chorus	Similar in principle to Chorus, but intended for vintage electric piano sounds.
Ensemble	Applies a three-phase chorus to the sound, providing additional richness.
Tremolo	Continuously varies the volume at a constant speed, adding a vibrato type effect to the sound.
Classic Tremolo	Similar in principle to Tremolo, but intended for vintage electric piano sounds.
Vibrato Tremolo	Similar in principle to Tremolo, but with an additional Vibrato effect applied.
Auto Pan	Alternates the sound output from left to right across the stereo field using a sine wave.
Classic Auto Pan	Similar in principle to Auto Pan, but intended for vintage electric piano sounds.
Phaser	Applies a cyclic phase change to the sound, giving the impression that the sound is moving.
Classic Phaser	Similar in principle to Phaser, but intended for vintage electric piano sounds.
Rotary (1~6)	<p>Simulates the sound of a rotary speaker commonly used with vintage electronic organs. There are three different levels of overdrive, with and without a Chorus effect.</p> <ul style="list-style-type: none"> <li>• The soft pedal can be used to alternate the speed of the rotary simulation between “Slow” and “Fast” effect modes.</li> </ul>
Combination Effects	<p>Different combinations of the above effects, applied simultaneously.</p> <ul style="list-style-type: none"> <li>• Combination effect types: Phaser+Chorus, Phaser+AutoPan</li> </ul>
Amplified Effects	<p>A selection of the above effects, with a vintage electric piano speaker effect applied.</p> <ul style="list-style-type: none"> <li>• Amplified effect types: Tremolo+Amp, Auto Pan+Amp, Phaser+Amp</li> </ul>

## ■ Effect parameters

Effect parameter	Effect setting	Description
Mono Delay / PingPong Delay / Triple Delay	Dry / Wet	Adjust the intensity of the delay.
	Time	Adjust the interval of time between each delay.
Chorus / Ensemble	Dry / Wet	Adjust the intensity of the chorus.
	Speed	Adjust the speed of the chorus.
Classic Chorus	Mono / Stereo	Toggle between a Mono or Stereo effect.
	Speed	Adjust the speed of the chorus.
Tremolo / Classic Tremolo / Vibrato Tremolo	Dry / Wet	Adjust the intensity of the tremolo.
	Speed	Adjust the speed of the tremolo.
Auto Pan / Classic Auto Pan	Dry / Wet	Adjust the intensity of the pan.
	Speed	Adjust the speed of the pan.
Phaser / Classic Phaser	Dry / Wet	Adjust the intensity of the phaser.
	Speed	Adjust the speed of the phaser.
Rotary	Accel. Speed	Adjust the acceleration speed between slow and fast modes.
	Rotary Speed	Adjust the speed of the rotary speaker.
Combination Effects / Amplified Effects	Dry / Wet	Adjust the intensity of the effects.
	Speed	Adjust the speed of the effects.

## (6) Tuning

In the Tuning area, tap the [-] and [+] buttons to change the Tuning value.

The Tuning value can be adjusted in 0.5 Hz increments within the range of 427.0~453.0 Hz.

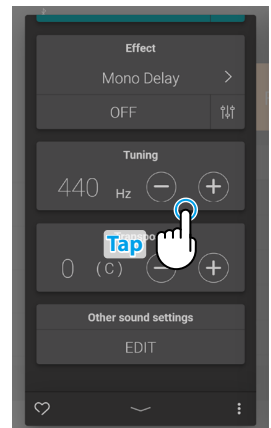

## (7) Transpose

In the Transpose area, tap the [-] and [+] buttons to change the Transpose value.

The Transpose value can be adjusted in semi-tone increments within the range of -12~12.

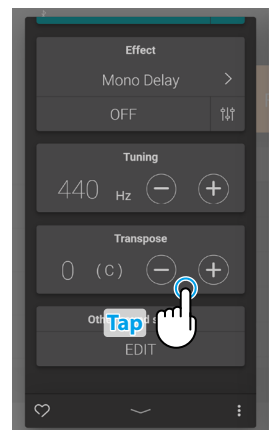

## (8) Other sound settings

When a non-piano sound is selected, the “Virtual Technician” area will be replaced by an “Other sound settings” area, which contains similar adjustable settings.

The number of adjustable items will change depending on the selected Main sound.

Ref. “Virtual Technician” P. 54

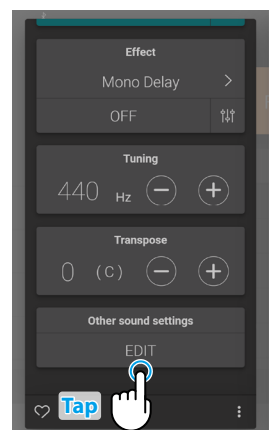

## (9) Favorite

Tap the  button to add the current sound to the Favorites category of the Sound tab.

Tap the  button again to remove the sound from the Favorites category.

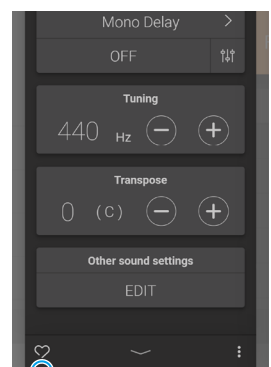

Tap 

## (10) Menu

Tap the  button to open the menu.

The following options will be displayed:

- **Save this sound**

This option will save the current sound settings as a User Sound to the "User" category of the Sound tab.  
Follow the steps according to the dialog that appears in the display.

- **Open Recorder**

This option will display the Recorder screen.  
Use this option to display the Recorder screen while the Recorder is stopped.

 "Recorder screen" P. 47

- **Open Metronome**

This option will display the Metronome screen.  
Use this option to display the Metronome screen while the Metronome is stopped.

 "Using the Metronome" P. 44

Tap an area outside of the options to close the menu and return to the Editor window.

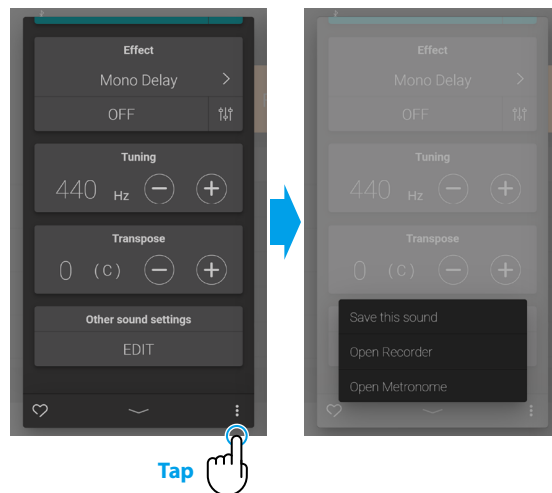

## 1. Music tab home screen overview

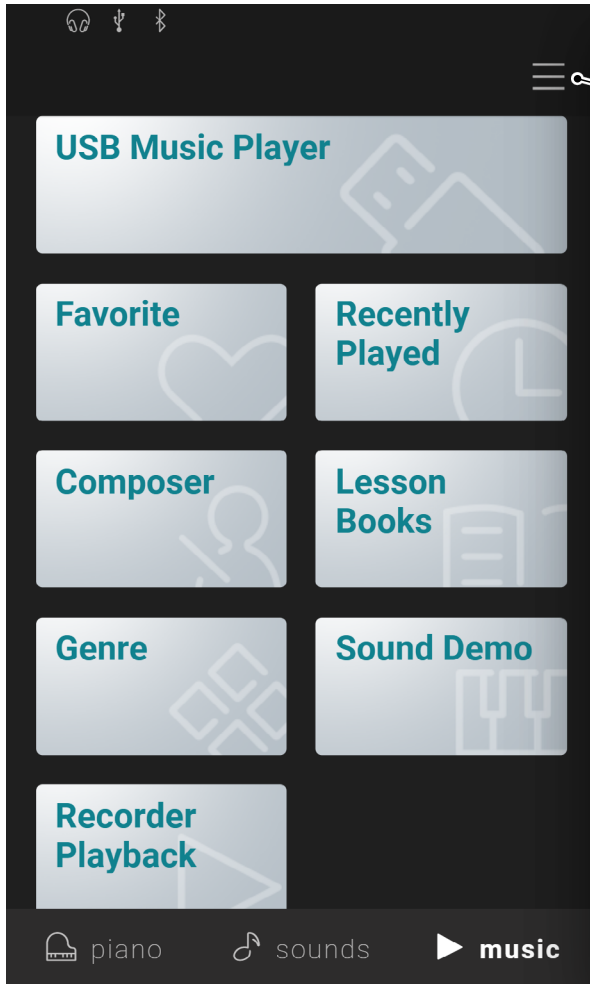

### Menu button Ref. P. 65

This button is used to display the menu, which provides access to various settings that control the hybrid piano.

### Category selection

Category	Description
USB Music Player	Replay songs/pieces and audio files stored on a USB memory device.
Favorite	Songs/pieces that have been specified as a Favorite.
Recently Played	Songs/pieces that have been played previously (up to 30 pieces).
Composer	Songs/pieces sorted by composer.
Lesson Books	Songs/pieces sorted by lesson book.
Genre	Songs/pieces sorted by musical genre.
Sound Demo	Songs/pieces to demonstrate different instrument sounds.
Recorded songs	Songs/pieces recorded to the instrument's internal memory, or saved to a USB memory device.

### CHECK

- The "Favorite" and "Recently Played" categories will only be displayed if a song/piece has been selected and/or specified as a Favorite.
- The "Recently Played" category will remember up to 30 songs/pieces. When the history exceeds 30 items, the bottom-most song/piece will disappear.
- The "Recorder Playback" category will only be displayed if a song/piece has been recorder to the instrument's internal memory.

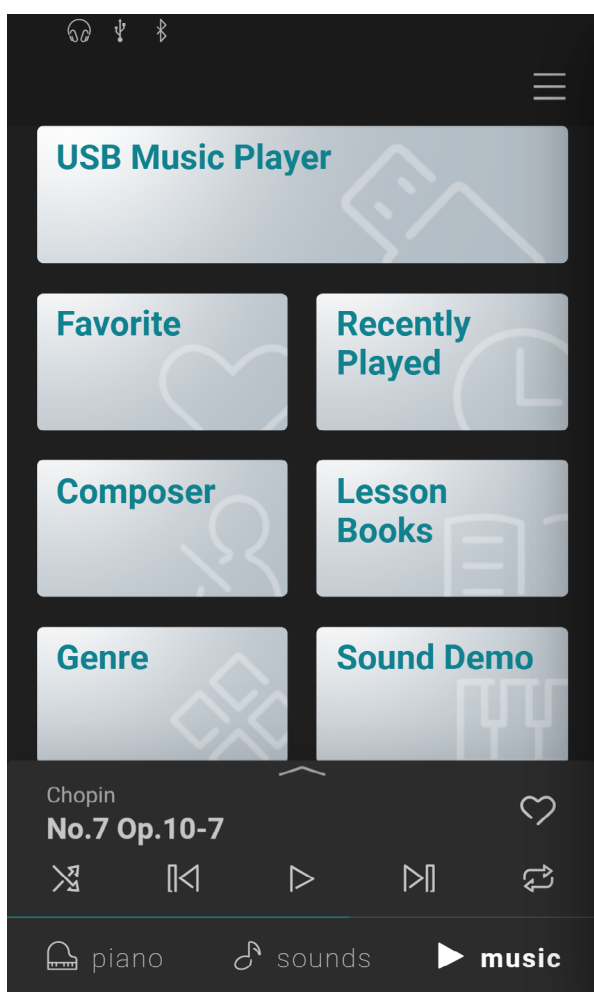

### Mini player

This area controls the playback of built-in songs/pieces, and songs recorded to this instrument's internal memory or a USB memory device.

## 2. Player screen overview

### Player

This button switches to the Player function.

### Concert Magic

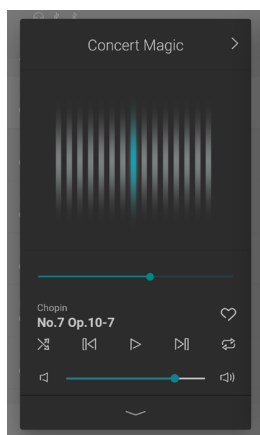

This button switches to the Concert Magic function.

Concert Magic allows complete beginners to enjoy playing the piano simply by selecting one of the internal songs/pieces, then tapping the keyboard with a steady rhythm and tempo.

### Song/piece information

This area indicates the title and composer of the current song/piece.

### Player menu

Icon	Name	Description
	Replay	Play the selected song/piece.
	Pause	Pause song/piece playback.
	Backward	Jump to the previous song/piece.
	Forward	Jump to the next song/piece.
	Repeat Playlist	Repeat the current playlist continuously.
	Shuffle	Automatically select and play songs/pieces from the current playlist at random.

### Expand/shrink Player

This button toggles between the Player and Mini Player view.

Tap the button to shrink the player controls and switch to the Mini player view.

Tap the button to expand the player controls and switch to the normal player view.

### Mini player

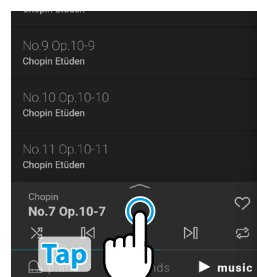

## Lesson

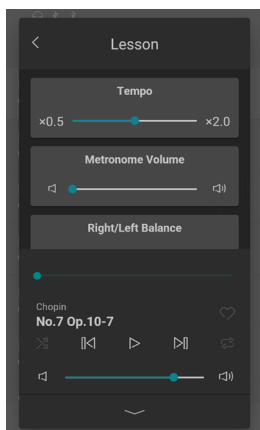

This button switches to the Lesson function.  
The Lesson function allows built-in songs/pieces to be used as piano lessons.

Function	Description
Tempo	Adjust the playback tempo of the current song/piece.
Metronome Volume	Adjust the volume of the Metronome.
Left/Right Balance	Adjust the volume balance between the Left/Right hand parts of the current song/piece. This setting is used to adjust the volume balance between the Main (right section) and Sub (left section) sounds.
Transpose	Adjust the playback pitch of the currently song/piece in semi-tone steps.
AB Repeat	Repeat a passage of the song/piece continuously.

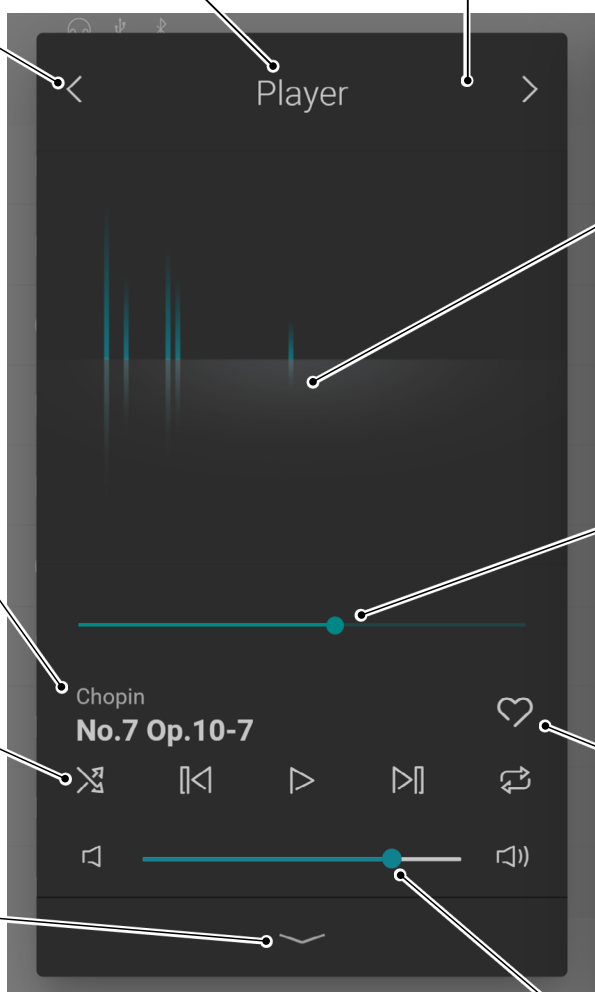

### Animation

This area displays an animation that matches the rhythm of the current song/piece.

### Playing position

This slider indicates the playing position of the current song/piece. Drag the slider right/left to change the current playing position.

### Favorite

This button is used to specify a Favorite song/piece.  
Tap the button to add the current song/piece to the Favorites category of the Music tab.  
Tap the button again to remove the song/piece from the Favorites category.

### Volume

This slider indicates the playback volume of the current song/piece. Drag the slider right/left to decrease/increase the playback volume.

### 3. Player screen functions

The Player screen is used to control the playback of internal songs/pieces, but also allows interaction with the music using the Concert Magic and Lesson functions. The Player screen is also used to control the playback of songs and audio files stored on a USB memory device.

#### (1) Player

The Player function is used to playback song/pieces and audio files.

##### ■ Playable media

- Internal songs/pieces
- Songs/pieces recorded to the instrument's internal memory.
- SMF (format 0, format 1) song files saved to a USB memory device.
- MP3 (44.1 kHz / 16 bit) audio files saved to a USB memory device.
- WAV (44.1 kHz / 16 bit) audio files saved to a USB memory device.

#### (2) Lesson

The Lesson function is used to practise internal songs/pieces.

1. From the Music tab, select a song/piece to be used for practise, then tap the  button to switch to the expanded Player view.

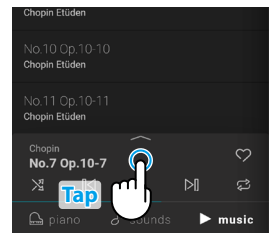

2. Tap the  button in the top right corner of the Player to switch to the Lesson function.

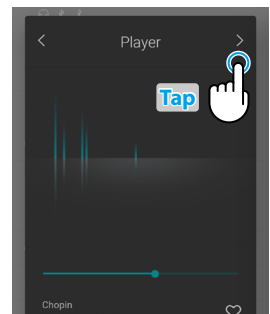

##### ■ Lesson Function features

- Practice the left and right-hand parts of a song/piece separately.
- Adjust the tempo of a song/piece in order to master difficult passages.
- Repeat a passage of the song/piece continuously.

#### CHECK

- The tempo of some songs/pieces will automatically be set to a slower tempo in order to simplify the practice.
- When practicing certain Burgmüller pieces, reducing the tempo may not change the length of the fermata.
- The volume of fortissimo strokes may be lowered in some songs/pieces in order to reduce excessive load to children's fingers during practice.
- Expression markings such as dynamics used in the Back Invention lesson book adhere to the reference scores published by Kawai.
- The pieces of the Chopin Waltzes lesson book are purposely played slightly out of the metronome beat, in order to express the swinging rhythm of waltz and the cadence of some phrases. Please use the metronome as a loose guide when practising these pieces.



## ■ Adjusting Lesson song balance

It is also possible to adjust the volume balance between the right-hand and left-hand parts of the current lesson song/piece, allowing each hand to be practiced separately.

Drag the Balance slider right/left to increase the volume of the right-hand/left-hand parts, while reducing the volume of the other part.

To practise the right-hand part while hearing the left-hand part, drag the Balance slider to the leftmost position.

To practise the left-hand part while hearing the right-hand part, drag the Balance slider to the rightmost position.

### ☑ CHECK

For some Beethoven lesson pieces, moving the Balance slider to the left will reduce the volume of the student's part, while moving the Balance slider to the right will reduce the volume of the teacher's part.

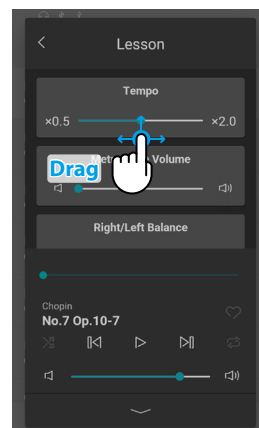

## ■ Practising a passage repeatedly

The Lesson function also allows passages of a song/piece to be repeated continuously, by specifying the start and end points.

1. Select the desired song/piece to practise and start playback.
2. Tap the [A] button to specify the start point of the passage to be repeated.

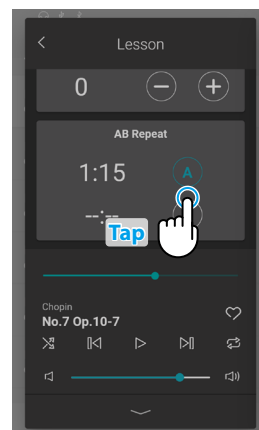

3. Tap the [B] button to specify the end point of the passage to be repeated.

The passage will repeat from the A point until the B point continuously.

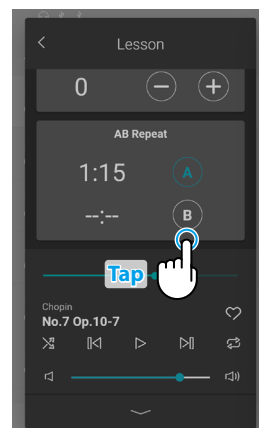

Tap the [A] and [B] buttons to turn off the repeat function and restore the normal playback method.

## (3) Concert Magic

Concert Magic allows complete beginners to enjoy playing the piano simply by selecting one of the built-in songs/pieces, then tapping the keyboard with a steady rhythm and tempo.

The tempo and dynamics of the song/piece will change according to the speed and pressure of the key tapping.

1. From the Music tab, select a song/piece to be used for Concert Magic, then tap the  button to switch to the expanded Player view.

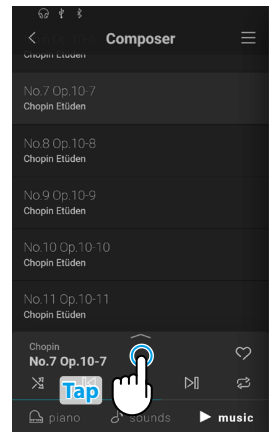

### ✓ CHECK

Some built-in songs/pieces are not compatible with the Concert Magic function. In this case, only the Player function can be used.

2. Tap the  button in the top right corner of the Player to switch to the Lesson function.

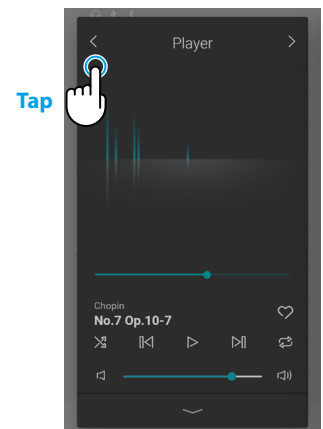

3. Press a key on the keyboard.

The selected song/piece will advance with every key that is pressed. Pressing the keys gently will produce a soft sound, while pressing heavily will produce a loud sound.

Pressing quickly will increase the playing tempo, while pressing slowly will decrease the tempo.

An animation will be displayed as the song/piece is performed.

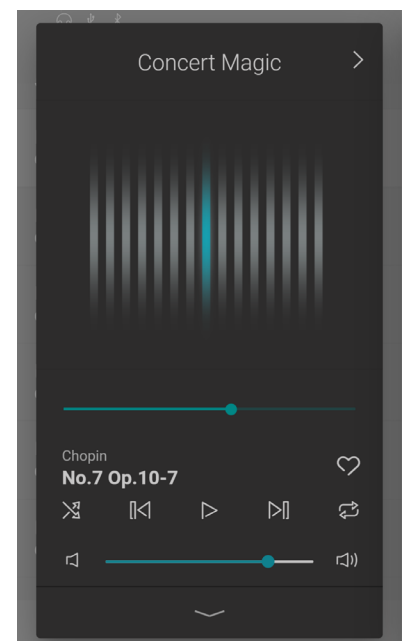

M E M O

# Using the Metronome

The Metronome function provides a steady beat to aid practicing the piano at a consistent tempo. In addition to regular metronome beats, the hybrid piano also features a variety of drum rhythms to accompany most playing styles and musical genres. The Metronome function is available on both the Pianist mode screen and the Sound mode screen.

## Turning the Metronome on/off

1. Tap the  button.

The button will change colour, and a metronome beat will start to count.

The Metronome settings screen will be displayed, indicating the current tempo and time signature (beat).

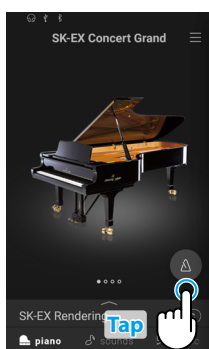

2. Tap the  button again.

The button will change colour and the Metronome will stop counting.

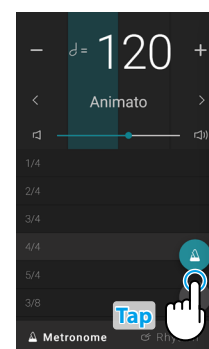

## Metronome mode settings screen

### Beat indicator

This area indicates the current beat of the bar by flashing sections of the background in sequence.

### Tempo term

This area indicates the Metronome tempo term. Tap the < > buttons to change the preset tempo term.

### Tempo

This area indicates the Metronome tempo in BPM.

Tap the [-] [+] buttons or swipe left/right to adjust the tempo in single beat intervals. Swipe up/down to adjust the value in 10 beat intervals.

The metronome tempo can be adjusted within the range of 10~400 BPM.

### Volume

This slider indicates the Metronome volume. Drag the slider right/left to decrease/increase the Metronome volume.

### Time signature

This area indicates the current Metronome time signature.

Swipe up/down to scroll through the list, then tap the desired time signature to select it.

### Start/Stop button

This button indicates the Metronome state. Tap the button to start/stop the Metronome counting.

### Mode selection button

This area indicates the current Metronome mode. Tap to switch between Metronome and Rhythm mode.

### Close button

Tap this button to close the Metronome settings screen and return to the Piano/Sound tab home screen.

The Metronome will continue to count, allowing the sound to be changed, or for the Recorder to be used etc.

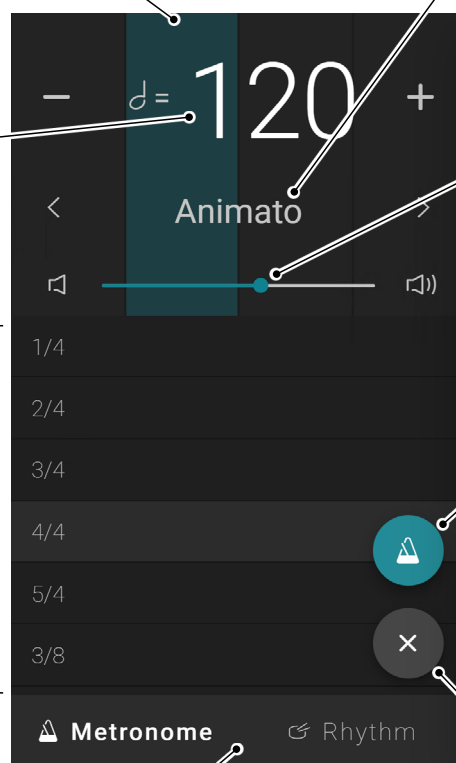

## Rhythm mode settings screen

### Beat indicator

This area indicates the current beat of the bar by flashing sections of the background in sequence.

### Tempo

This area indicates the Rhythm tempo in BPM. Tap the [-] [+] buttons or swipe left/right to adjust the tempo in single beat intervals. Swipe up/down to adjust the value in 10 beat intervals.

The metronome tempo can be adjusted within the range of 10~400 BPM.

### Volume

This slider indicates the Metronome volume. Drag the slider right/left to decrease/increase the Rhythm volume.

### Start/Stop button

This button indicates the Rhythm state. Tap the button to start/stop the Rhythm counting.

### Close button

Tap this button to close the Metronome settings screen and return to the Piano/Sound tab home screen.

The Metronome will continue to count, allowing the sound to be changed, or for the Recorder to be used etc.

### Rhythm Ref. P. 80

This area indicates the current drum rhythm. Swipe up/down to scroll through the list, then tap the desired drum rhythm to select it.

### Mode selection button

This area indicates the current Metronome mode. Tap to switch between Metronome and Rhythm mode.

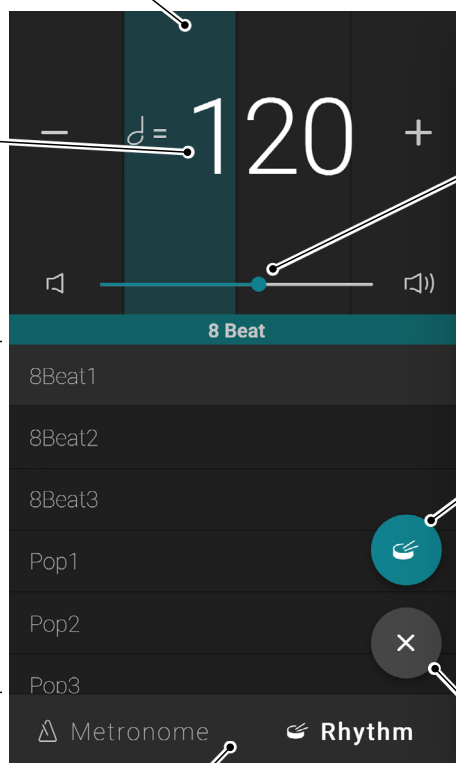

# Recorder

The Recorder function allows performances to be recorded and stored in the hybrid piano's internal memory, or saved to a connected USB memory device.

Performances can be recorded using the Mini Recorder or the main Recorder screen.

## Mini Recorder

The Mini Recorder appears as the **REC** button on the right side of the Selection bar, on the Piano/Sound tab home screens.

This button provides a quick way to start and stop recording without opening the main Recorder screen. This recording method also allows the sound to be changed or the Metronome enabled during recording.

### Recording status

This area indicates the Recorder status (Standby, Recording...).

When the recorder is in use (Standby, Recording), tap this area to open the Recorder screen.

When the recorder is not in use, the selected sound name will be shown.

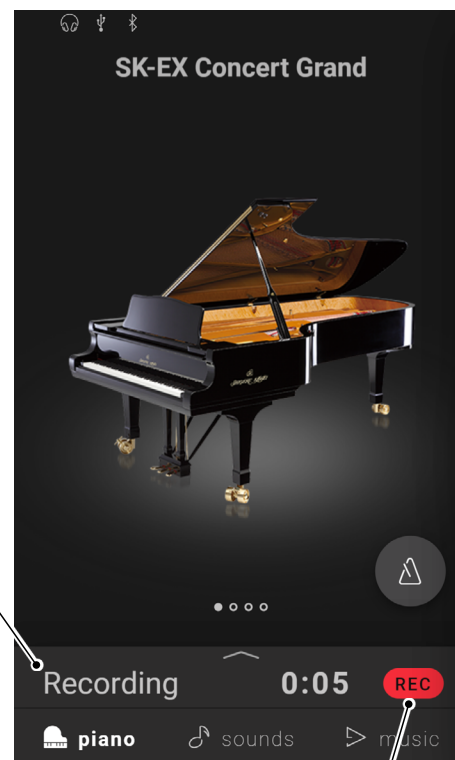

### Recorder button Ref. P. 48

This button is used to change the state of the Recorder.

**REC** (Inactive): The Recorder is not in use.

**REC** (Standby): The Recorder is in standby, and will start with the next key press.

**REC** (Recording): The Recorder is recording.

## Recorder screen

The Recorder screen provides more detailed information about the recording process and additional functions such as the recording format and overdubbing.

The Recorder screen can be opened by tapping the Recording status bar while the Recorder is in standby or recording.

**Recording time**  
This area indicates the recording time.

**Recording status**  
This area indicates the Recorder status (Standby, Recording...).

**Overdubbing song title**  
This area indicates the title of the song selected for overdubbing.

**Close Recorder**  
Tap this area to close the Recorder screen and return to the Piano/Sound tab home screens. The recording status will continue to be shown in the Mini Recorder.

**Recorder menu button**  
This button is used to display the Recorder menu. This button will be hidden during recording.

**Record button**  
This button is used to change the state of the Recorder.

- (Inactive): The Recorder is not in use.
- (Standby): The Recorder is in standby, and will start with the next key press.
- (Recording): The Recorder is recording.

**Song selection button**  
This button is used to display the song selection screen for overdubbing. This button will be hidden during recording.

**Play button**  
This button is used to play the song that has been selected for overdubbing. This button will be hidden during recording.

**CHECK**

This button will only be shown when a USB memory device is connected.

## (1) Recording

1. Tap the **REC** button on the Piano/Sound tab home screen.

The button will change to **REC** to indicate that the Recorder is in standby mode.

Tap and hold the **REC** button to cancel the Recorder while in standby mode.

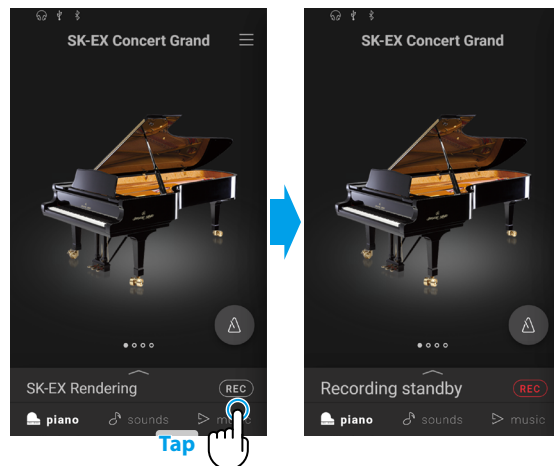

2. Press a key on the keyboard or tap the **REC** button tap again to start recording.

It is also possible to start recording by tapping the Selection bar to enter the Recorder screen, then tapping the **REC** button.

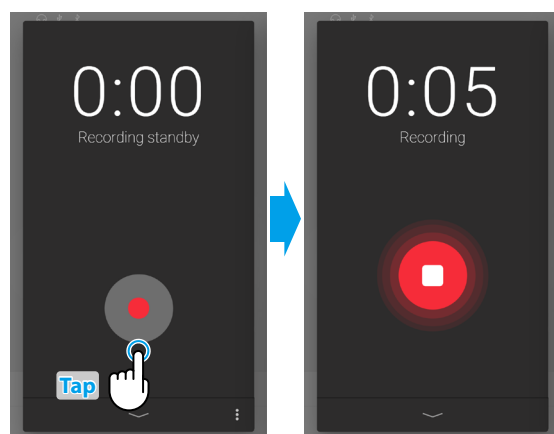

• The Recorder screen changing from Standby to Recording.

3. Tap the **REC** or **REC** buttons again to stop recording.

The Recording completed screen will appear.

4. Tap the [Playback] button to playback the recorded performance.

Tap the [Save] button to save the recorded performance, or the [Delete] button to delete it.

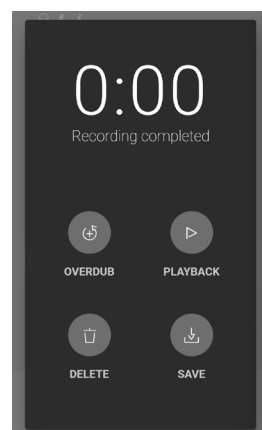

### ✓ CHECK

Depending on the selected recording format, the recorded performance will be saved to either the instrument's internal memory or a USB memory device.

Ref. "Recording format" P. 52





## Overdubbing (dubbing performances while listening to a song)

### ■ Overdubbing a recorded song: Method 1

1. Record a performance in the normal way, then tap the [Overdub] button on the Recording completed screen.

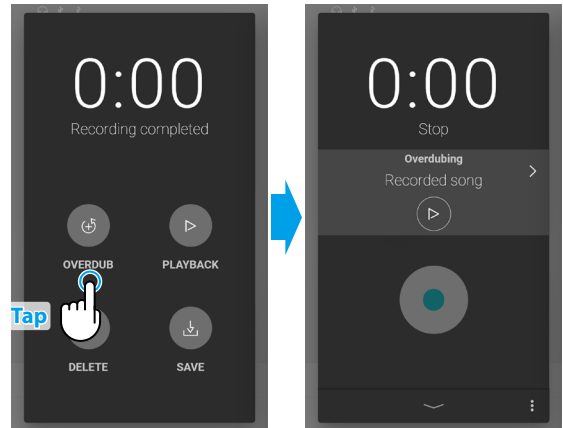
The Recording start screen will appear.



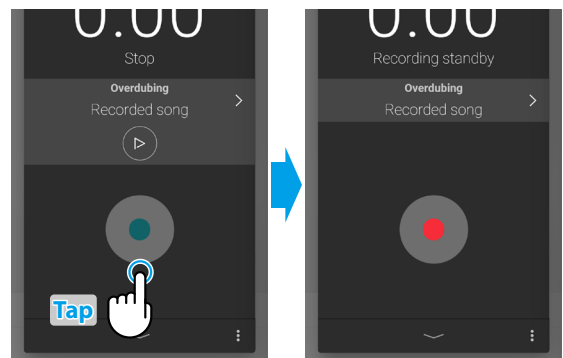

2. Tap the  button to enter Standby mode.

Tap and hold the  button to cancel the Recorder while in standby mode.

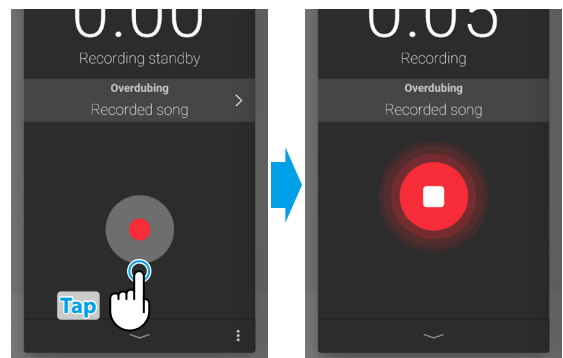

3. Press a key on the keyboard or tap the  button tap again to start recording.



4. Tap the  buttons again to stop recording.

The Recording completed screen will appear.

5. Tap the [Playback] button to playback the recorded performance.

Tap the [Save] button to save the recorded performance, or the [Delete] button to delete it.

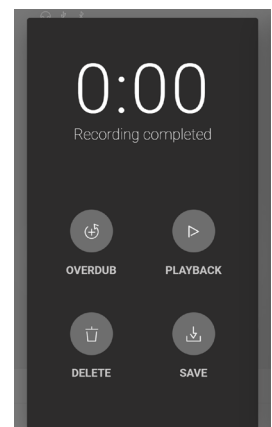

### ☑ CHECK

When overdubbing a performance recorded to the instrument's internal memory, overdubbing can only be used once.  
In order to use multiple overdubs, please select the WAV (or MP3) audio recorder format to enable recording to USB memory.

# Recorder

## ■ Overdubbing a recorded song: Method 2

1. From the Piano/Sound Editor window, tap the  button, then select "Open Recorder."

The Recording start screen will appear.

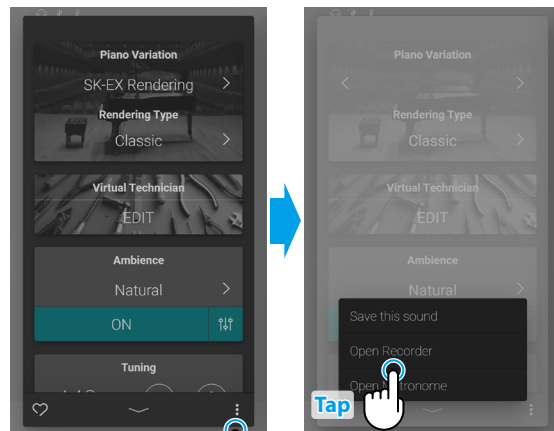

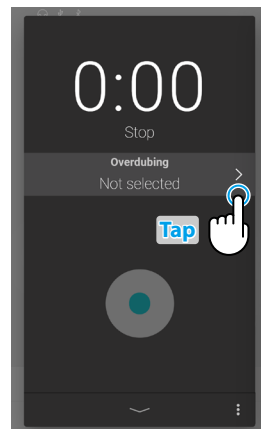

2. Tap the  button.

The internal song selection screen will appear.



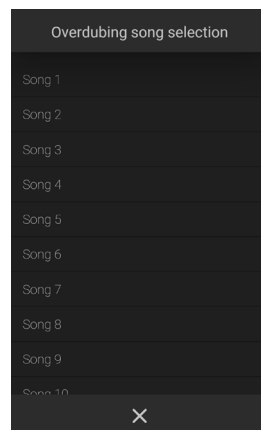

3. Tap the song to be overdubbed to.



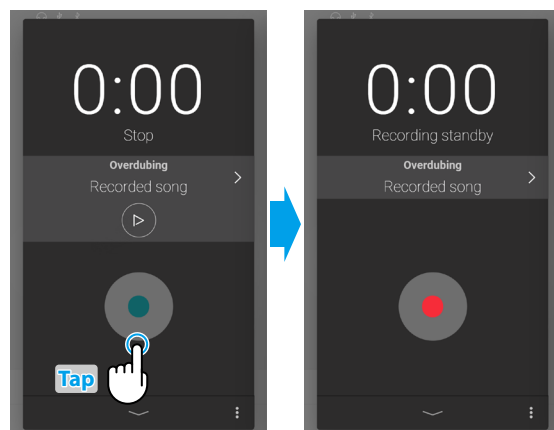

4. Tap the  button to enter Standby mode.

Tap and hold the  button to cancel the Recorder while in standby mode.

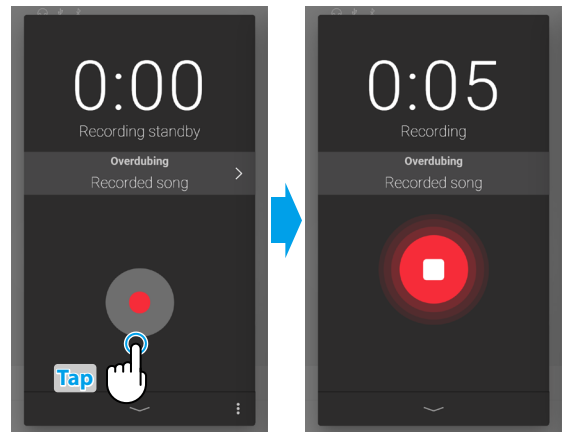

5. Press a key on the keyboard or tap the  button tap again to start recording.



6. Tap the  button again to stop recording.

The Recording completed screen will appear.

7. Tap the [Playback] button to playback the recorded performance.

Tap the [Save] button to save the recorded performance, or the [Delete] button to delete it.

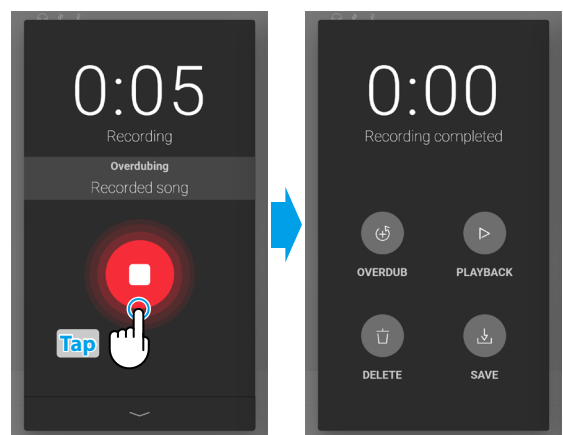

# Recorder

## (2) Recorder menu

### ■ Recording format

Performances can be recorded in three formats: Internal, WAV, and MP3.

Recording format	Recording (saving) destination	
Internal	Internal memory	Maximum 10 songs
MP3	USB memory	Bitrate: 256 kbps (CBR) Sampling Frequency: 44.1 kHz 16-bit, Stereo
WAV		Bitrate: 1,411 kbit/s (uncompressed) Sampling Frequency: 44.1 kHz 16-bit, Stereo



### ■ Recording level

When recording WAV or MP3 audio format songs to a USB memory device, the Recording level setting allows the recording level (gain) to be adjusted.

Drag the slider right/left to adjust the recording level.

### ☑ CHECK

- Express caution when increasing the gain setting, as higher levels may result in distorted recordings.
- The Recording level setting will be hidden when the Recording format is set to Internal.
- The Recorder menu will be hidden if a USB memory device is not connected.

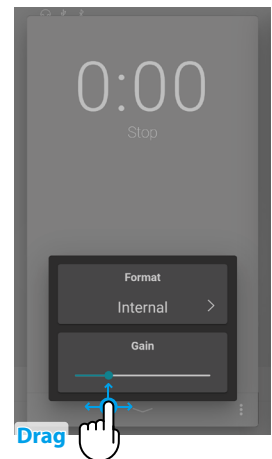

## Recording to the instrument's internal memory

---

The total capacity of the instrument's internal recorder memory is approximately 90,000 notes.

- For reference, a 5000 note recorder capacity would be sufficient to record the Beethoven piece 'Für Elise' approximately 3~4 times, which is the equivalent of 10~15 minutes of recording.

However, the total recording time will change depending on the number of notes played and the tempo of the piece. In addition, pedal presses will also influence the maximum recording length, with each pedal press the equivalent of one note.

If the maximum recording capacity is reached during recording, the recorder will stop automatically. The performance will be recorded until the recorder is stopped.

Performances recorded to the instrument's internal memory will remain after the power is turned off.

The Recorder will capture sound changes during recording.

The recorder will capture switching to Dual or Split playing mode.

The Recorder will not capture changes to the Metronome tempo settings made during the recording. Performances will be recorded at the tempo specified immediately before recording.

---

## About recording to a USB memory device

---

When recording a WAV or MP3 audio file to a USB memory device, the metronome/drum rhythm sound will not be recorded.

# Virtual Technician

An experienced piano technician is essential to fully realise the potential of a fine acoustic piano. In addition to meticulously tuning each note, the technician also performs numerous regulation and voicing adjustments that allow the instrument to truly sing.

The Virtual Technician settings of the hybrid piano simulate these refinements digitally, allowing performers to shape various aspects of the instrument's character to suit their personal preferences.

## ☑ CHECK

When a non-piano sound is selected, the "Virtual Technician" area will be replaced by an "Other sound settings" area, which contains similar adjustable settings.

## Entering the Virtual Technician

From the Piano window, tap the Selection bar to open the Piano Editor window, then tap [EDIT] button in the Virtual Technician area.

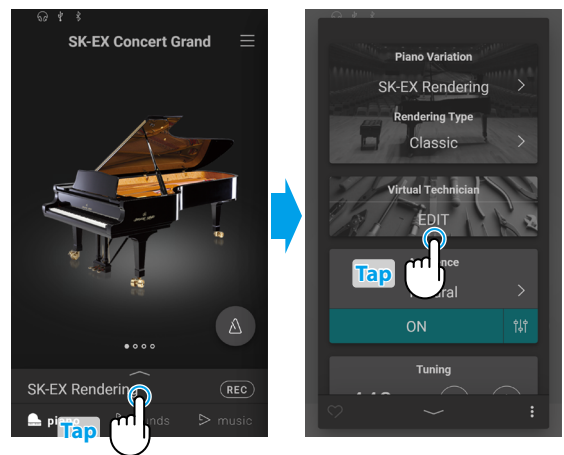

## About Virtual Technician edit screen

From the Virtual Technician edit screen, tap the parameter to be adjusted, then change the value/type as desired.

## ☑ CHECK

The number of adjustable Virtual Technician parameters will vary depending on the selected sound.

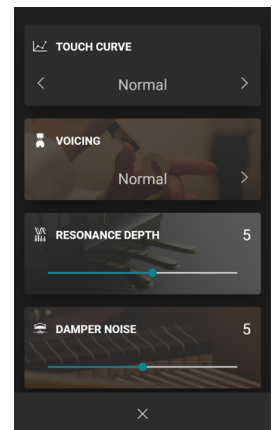

The following pages explain the purpose of each parameter, the setting values, and adjustment method as follows:

Parameter name

Parameter explanation

Adjustable value

**(14) Decay Time** Drag

When playing an acoustic grand piano, the length of the instrument influences the speed at which held notes decay, with longer grand pianos (i.e. longer strings) characterised by longer decay times.

The hybrid piano simulates this characteristic, with the Decay Time setting allowing the length of decay while keys are pressed to be adjusted.

Value	Description
1	Held notes will decay quickly.
⋮	⋮
10	Held notes will decay slowly.

Adjustment method

Swipe

Scroll

Drag

Tap

Adjustment result



## (1) Touch Curve

As with an acoustic piano, the hybrid piano produces a louder sound when the keys are struck with force, and a softer sound when the keys are played gently. The volume and tonal character change in relation to the strength and velocity of playing – on a hybrid piano this system is referred to as “touch sensitivity”.

The Touch Curve setting allows the touch sensitivity of the keyboard to be conveniently adjusted. There are ten different preset touch curve settings available.

The default “Normal” setting is designed to accurately recreate the touch of a Kawai concert grand piano. However, if the keyboard feels too light, or fortissimo playing is achieved too easily, it may be desirable to select a heavier touch curve. Alternatively, if the keyboard feels too heavy, or fortissimo playing is too difficult to achieve, it may be desirable to select a lighter touch curve.

Type	Description
Light (4/3/2/1)	Light touch curves require less striking force to achieve a forte note, and are therefore recommended for players with a delicate touch. The key touch will become progressively lighter as the number increases.
Normal	Reproduces the standard touch sensitivity of an acoustic piano.
Heavy (1/2/3/4)	Heavy touch curves require more striking force in order to achieve a forte, and are therefore recommended for players with stronger fingers. The key touch will become progressively heavier as the number increases.
Off (constant)	A constant volume is produced regardless of how hard the keys are struck. <ul style="list-style-type: none"><li>• This touch curve intended for playing sounds of instruments that have a fixed dynamic range (e.g. organ and harpsichord).</li></ul>

M E M O



## (2) Voicing

On an acoustic piano, the shape, density, and texture of the hammers all influence on the tonal character of the instrument's sound. Technicians utilise a variety of tools such as needles, files, and brushes to manipulate these hammer felts, with the ultimate goal of achieving a balanced tonal character across the keyboard.

The Voicing setting recreates various hammer properties, allowing the overall tonal character of the hybrid piano to be adjusted. There are six different preset voicing settings available (applied uniformly to all keys).

While the default "Normal" voicing setting should be appropriate for a broad range of musical genres, it may be desirable to select a softer, more mellow tonal character for romantic pieces, or a brighter, more aggressive tone for modern styles.

Type	Description
Normal	The normal tonal character of an acoustic piano throughout the entire dynamic range.
Mellow 1	A softer, more mellow tonal character throughout the entire dynamic range.
Mellow 2	An even softer tonal character than Mellow 1.
Dynamic	A tonal character that changes dramatically from mellow to bright, depending on the strength of key strike.
Bright 1	A bright tonal character throughout the entire dynamic range.
Bright 2	An even brighter tonal character than Bright 1.



## (3) Resonance Depth

The Resonance Depth setting allows the overall resonance depth of the SK-EX Rendering sound engine to be adjusted.

Value	Description
1	A small amount of Resonance will be applied to the selected SK-EX Rendering sound type.
⋮	⋮
10	A large amount of Resonance will be applied to the selected SK-EX Rendering sound type.

### CHECK

This setting will only be displayed when the "SK-EX Rendering" piano sound variation is selected.





#### (4) Damper Resonance

Pressing the damper pedal of an acoustic piano raises all dampers, allowing the strings to vibrate freely. When a note or chord is played on the piano with the sustain pedal pressed, not only will the strings of the notes played vibrate, but also the strings of other notes, vibrating in sympathetic resonance.

The hybrid piano recreates this phenomenon, with the Damper Resonance setting allowing the volume of this resonance sound to be adjusted.

Value	Description
Off	Damper Resonance will not be applied to the selected sound.
1	A small amount of Damper Resonance will be applied to the selected sound.
⋮	⋮
10	A large amount of Damper Resonance will be applied to the selected sound.

#### CHECK

This setting will not be displayed when the "SK-EX Rendering" piano sound variation is selected.



#### (5) Damper Noise

When the damper pedal of an acoustic piano is pressed and released, it is often possible to hear the sound of the damper head touching and releasing the strings.

The hybrid piano reproduces this sound, with the Damper Noise setting allowing the volume of this sound to be adjusted. The speed at which the damper pedal is pressed and released will also influence the prominence of the damper noise, with fast pedalling creating a more pronounced sound.

Value	Description
Off	Damper Noise will not be applied to the selected sound.
1	A small amount of Damper Noise will be applied to the selected sound.
⋮	⋮
10	A large amount of Damper Noise will be applied to the selected sound.



#### (6) String Resonance

String Resonance refers to a phenomenon that exists in acoustic pianos whereby the strings of held notes resonate "sympathetically" with other notes of the same harmonic overtone series.

The hybrid piano recreates this phenomenon, with the String Resonance setting allowing the volume of this resonance to be adjusted.

Value	Description
Off	String Resonance will not be applied to the selected sound.
1	A small amount of String Resonance will be applied to the selected sound.
⋮	⋮
10	A large amount of String Resonance will be applied to the selected sound.

#### CHECK

This setting will not be displayed when the "SK-EX Rendering" piano sound variation is selected.

## ■ Demonstrating String Resonance

To experience the string resonance phenomenon, gently hold down the “C” key as shown in the illustration below, then play (strike and release quickly) any of the keys marked with a ● symbol. In addition to the sound of each note played, it should also be possible to hear the strings of the first “C” key resonating “sympathetically”, thus demonstrating String Resonance.

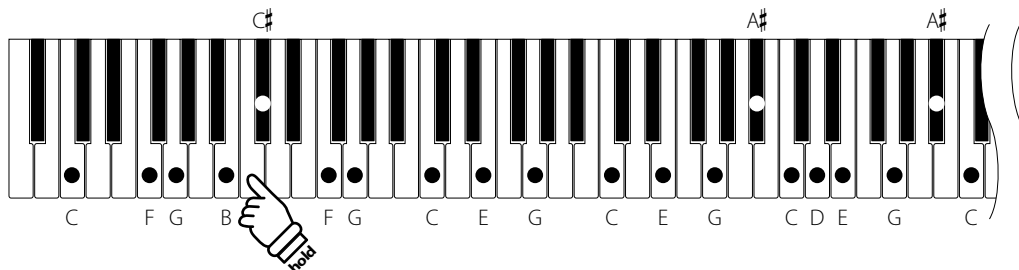

### CHECK

The location and volume of the resonance may vary depending on the piano sound and settings used.

## (7) Undamped String Resonance



The dampers of an acoustic piano span almost the full width of the keyboard. However, the topmost 18 keys (approximately 1.5 octaves) do not incorporate dampers, as the shorter strings for these treble notes decay quickly and therefore do not need to be dampened.

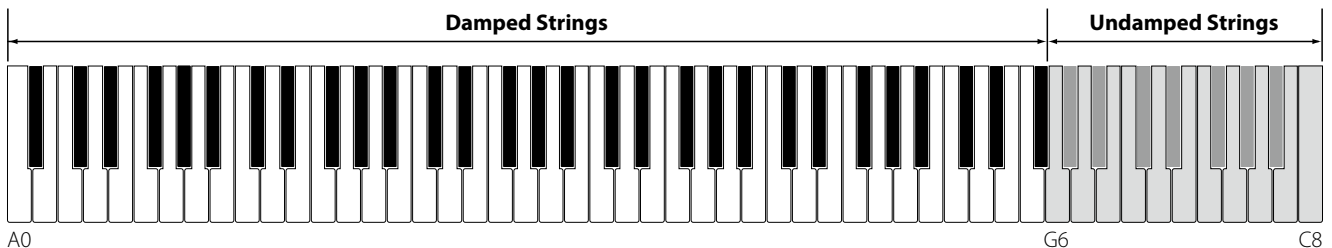

As a result, the strings of these “undamped” treble notes are free to vibrate in sympathetic resonance with those of lower keys – independently of the damper pedal position – helping to enrich the sound with additional harmonics and tonal colour.

The hybrid piano recreates this phenomenon, with the Undamped String Resonance setting allowing the volume of this resonance sound to be adjusted.

Value	Description
Off	Undamped String Resonance will not be applied to the selected sound.
1	A small amount of Undamped String Resonance will be applied to the selected sound.
⋮	⋮
10	A large amount of Undamped String Resonance will be applied to the selected sound.

### CHECK

This setting will not be displayed when the “SK-EX Rendering” piano sound variation is selected.



## (8) Cabinet Resonance

While the fundamental sound of an acoustic piano is produced by vibrating strings, transmitting energy through a spruce soundboard, the cabinet of the instrument itself also contributes a variety of subtle tonal characteristics that enrich the playing and listening experience. The keyboard, inner and outer rim, iron plate, and beams all play a role in disseminating sound energy, which in turn gives the piano a living, breathing quality.

The hybrid piano recreates these natural acoustic characteristics, with the Cabinet Resonance setting allowing the volume of this resonance sound to be adjusted.

Value	Description
Off	Cabinet Resonance will not be applied to the selected sound.
1	A small amount of Cabinet Resonance will be applied to the selected sound.
⋮	⋮
10	A large amount of Cabinet Resonance will be applied to the selected sound.

### CHECK

This setting will not be displayed when the "SK-EX Rendering" piano sound variation is selected.



## (9) Key-off Effect

When playing an acoustic piano – particularly in the bass region of the keyboard – if a key is played with force and released quickly, it is often possible to hear the faint sound of the damper touching the strings immediately before the vibrations are stopped.

The hybrid piano recreates this phenomenon, with the Key-off Effect setting allowing the volume of this sound to be adjusted.

Value	Description
Off	Key-off Effect will not be applied to the selected sound.
1	A small amount of Key-off Effect will be applied to the selected sound.
⋮	⋮
10	A large amount of Key-off Effect will be applied to the selected sound.



## (10) Fall-Back Noise

When playing an acoustic piano, it is often possible to hear the faint sound of the keyboard action returning (i.e. "falling back") to the neutral position after a key is released.

The hybrid piano reproduces this sound, with the Fall-back Noise setting allowing the volume of this sound to be adjusted.

While the default value is intended to simulate the natural volume level of the keys as they return to their neutral position, it may occasionally be desirable to adjust the volume of this sound. For example, reducing the volume when playing very soft pieces, where the fall-back noise may become too prominent.

Value	Description
Off	Fall-Back Noise will not be applied to the selected sound.
1	A small amount of Fall-Back Noise will be applied to the selected sound.
⋮	⋮
10	A large amount of Fall-Back Noise will be applied to the selected sound.



## (11) Hammer Noise

When playing an acoustic piano, it is also possible to hear the physical sound of the hammers striking the strings, along with the sound of the keys making contact with the piano keyboard.

The hybrid piano reproduces this sound, with the Hammer Noise setting allowing the volume of this sound to be adjusted.

While the default value is intended to simulate the natural volume level of an acoustic piano, it may be desirable to increase or decrease the volume of this sound to produce a more or less prominent attack.

Value	Description
Off	Hammer Noise will not be applied to the selected sound.
1	A small amount of Hammer Noise will be applied to the selected sound.
⋮	⋮
10	A large amount of Hammer Noise will be applied to the selected sound.



## (12) Hammer Delay

When playing pianissimo passages using an acoustic piano, there may be a perceived delay between a key being pressed and the hammer striking the strings.

If desired, the hybrid piano can recreate this delay, with the Hammer Delay setting allowing the delay length to be adjusted.

While the default value of "Off" is intended to replicate a well-regulated concert grand piano, with an immediate connection between the keyboard and hammers, some players may find it desirable to introduce a minor delay, in order to mimic different types of piano or instruments with a slightly worn keyboard action.

Value	Description
Off	Hammer Delay will not be applied to the selected sound.
1	A small amount of Hammer Delay will be applied to the selected sound.
⋮	⋮
10	A large amount of Hammer Delay will be applied to the selected sound.

## (13) Topboard



When playing an acoustic grand piano, the position of the instrument's topboard (lid) affects both the volume and "openness" of the tone produced. A fully open topboard allows sound waves to reflect off the polished lid surface and project into the room, while a closed lid has the opposite effect, resulting in a darker, more opaque tone.

The hybrid piano simulates these characteristics, with five different topboard positions.

Type	Description
Open3	Simulates the character of a fully open topboard, with maximum sound projection.
Open2	Simulates the character of a half open topboard, with reduced sound projection.
Open1	Simulates the character of a partially open topboard, with limited sound projection.
Closed2	Simulates the character of a closed rear topboard, but open front topboard, with limited sound projection.
Closed1	Simulates the character of a closed rear topboard and closed front topboard, with minimum sound projection.



## (14) Decay Time

When playing an acoustic grand piano, the length of the instrument influences the speed at which held notes decay, with longer grand pianos (i.e. longer strings) characterised by longer decay times.

The hybrid piano simulates this characteristic, with the Decay Time setting allowing the length of decay while keys are pressed to be adjusted.

Value	Description
1	Held notes will decay quickly.
⋮	⋮
10	Held notes will decay slowly.



## (15) Release Time

When playing an acoustic grand piano, the length of the instrument also influences the speed at which played (and released) notes decay, with longer grand pianos (i.e. longer strings) characterised by longer release times.

The hybrid piano simulates this characteristic, with the Release Time setting allowing the length of decay after keys are released to be adjusted.

Value	Description
1	Released notes will decay quickly.
⋮	⋮
10	Released notes will decay slowly.



## (16) Minimum Touch

The Minimum Touch setting allows the minimum key velocity required to produce a sound to be adjusted. By default, this setting recreates the extremely fine touch sensitivity of a concert grand piano, allowing a very soft sound to be produced with the slightest of key touches. However, it may be desirable to reduce this sensitivity, when wishing to recreate the sensitivity of a small grand piano or an upright piano.

Value	Description
1	A very gentle key press will produce a very soft sound.
⋮	⋮
20	A stronger key press will be required in order to produce a sound.



## (17) Stretch Tuning

Stretch tuning is a piano-specific tuning method used by acoustic piano technicians in which the lower octaves are tuned slightly flatter and the upper octaves are tuned slightly sharper to match the natural harmonics of an acoustic piano.

The Stretch Tuning setting allows the degree of stretch tuning to be adjusted when “Normal” is selected, or for stretch tuning to be completely disabled.

Type	Description
Off	Stretch tuning is disabled.
Normal	Normal stretch tuning is applied.
Wide	Wide stretch tuning is applied.



## (18) Temperament

The Temperament setting allows the tuning system used by the hybrid piano to be changed from the modern "Equal Temperament" standard to one of the various temperaments popularised during the Renaissance and Baroque periods.

Temperament type	Description
Equal Temperament (Equal)	This temperament is the most popular tuning method, and divides the scale into twelve equal semi-tones. This produces the same chordal intervals in all twelve keys, and has the advantage of limitless modulation of the key. However, the tonality of each key becomes less characteristic and no chord is in pure consonance.
Pure Temperament (Pure Major/Pure Minor)	This temperament, which eliminates dissonances for thirds and fifths, is still popular in choral music because of its perfect harmony. Any key modulation will result in dissonances.
Pythagorean Temperament (Pythagorean)	This temperament, which uses mathematical ratios to eliminate dissonance for fifths, is very limited for use with chords, but produces very characteristic melodic lines.
Meantone Temperament (Meantone)	This temperament, which uses a mean between a major and minor whole tone to eliminate dissonance for thirds, was devised to eliminate the lack of consonances experienced with certain fifths for the Mersenne pure temperament. It produces chords that are more beautiful than those played with equal temperament.
Werckmeister Temperament (Werckmeister)	These two temperaments are placed in between Meantone and Pythagorean. For music with few accidentals, this temperament produces the beautiful chords of the mean tone, but as accidentals increase, the temperament produces the characteristic melodies of the Pythagorean temperament.
Kirnberger Temperament (Kirnberger)	

### CHECK

The key of the temperament and major/minor setting must be correctly matched.

M E M O



## (19) Temperament Key

The Temperament Key setting allows the key of the selected temperament to be specified. When using a temperament other than Equal temperament, use this setting to specify the key signature of the piece.

### CHECK

If Equal Temperament is selected, setting the Temperament Key will have no effect.



## (20) Key Volume

The Key Volume setting allows the volume of different regions of the keyboard to be subtly reduced. There are four different damping presets available.

While the default "Normal" key volume setting should be appropriate for a broad range of musical genres, it may be desirable to experiment with different damping presets to attenuate or amplify the areas of the keyboard.

Type	Description
Normal	An evenly balanced volume throughout the keyboard.
High Damping	Gradually reduces the volume of the keyboard towards the treble region.
Low Damping	Gradually reduces the volume of the keyboard towards the bass region.
High & Low Damping	Gradually reduces the volume of the keyboard in both the treble and bass regions.
Center Damping	Gradually reduces the volume of the keyboard in the central region.



## (21) Half-Pedal Adjust

The Half-Pedal Adjust setting allows the point at which the damper pedal becomes effective (i.e. when the dampers of the piano begin to lift from the strings) to be adjusted. This setting may be useful for pianists that habitually rest their right foot on the damper/sustain pedal, but do not necessarily wish to sustain the sound.

Value	Description
1	This setting allows the half-pedal to start at the earliest point.
⋮	⋮
7	This setting allows the half-pedal to start at the latest point.
8	This setting is intended for using the pedal as a MIDI controller. The maximum value can be reached easily, without pressing the damper pedal fully.
⋮	⋮
10	This setting is intended for using the pedal as a MIDI controller. The maximum value will be reached when the damper pedal is pressed fully.



## (22) Soft Pedal Depth

The Soft Pedal Depth setting adjusts the extent to which the soft (left) pedal of the hybrid piano softens the sound of played notes.

While the default value is intended to replicate the effectiveness of a concert grand Una Corda pedal, it may be desirable for players to increase or decrease the value of this setting to suit their playing style.

On an acoustic grand piano, pressing this Una Corda pedal shifts the keyboard action slightly to the right, causing the hammers to strike two strings instead of the usual three, thus reducing the volume of each note.

Value	Description
1	The soft pedal will have a relatively small softening effect on the selected sound.
⋮	⋮
10	The soft pedal will have a relatively large softening effect on the selected sound.

## (23) Damper Hold

The Damper Hold setting is used to determine whether sounds such as organ or strings should be sustained continuously when the damper pedal is pressed, or whether these sounds should decay, naturally.

Type	Description
On	Organ, strings, etc. sounds will be sustained continuously while the damper pedal is pressed.
Off	Organ, strings, etc. sounds will gradually decay, even while the damper pedal is pressed.



# Settings Menu

The settings menu contains a variety of options to adjust the hybrid piano's operation and sound. These settings are grouped by category, providing convenient access to relevant controls.

Tap the ☰ button in the top right corner of the screen to open the Menu.

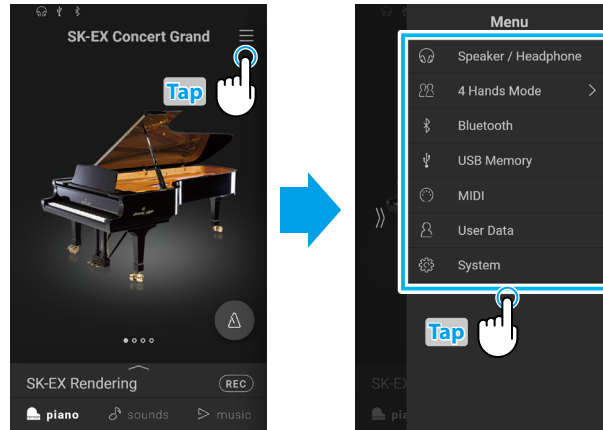

## 1. Speaker/Headphone

This menu category contains settings to adjust the sound heard through speakers and headphones.

### (1) Tone Control



The Tone Control setting allows the overall sound character of the hybrid piano to be adjusted to provide the best sound quality within the area that the instrument is located. There are eight different preset EQ settings available, with an additional "User" setting allowing finer control over the different frequency bands.

Type	Description
Flat	Tone control adjustment is not applied.
Brilliance	Adjusts the overall brightness of the sound, independently of the Virtual Technician "Voicing" parameter.
Bass Boost	Emphasises low-range frequencies, creating a deeper sound.
Bass Cut	Reduces low-range frequencies, creating a clearer sound.
Mid Boost	Emphasises mid-range frequencies, creating a harder sound.
Loudness	Emphasises frequencies to retain the instrument's sound character when playing at low volume levels.
Bright	Emphasises high-range frequencies, creating a brighter sound.
Mellow	Reduces high-range frequencies, creating a softer sound.
User	Allows the low, mid, and high-range frequency bands to be adjusted separately.

#### ■ Adjusting the Brilliance level

1. Tap the < > buttons to select the "Brilliance" Tone Control type.  
A slider will appear.
2. Drag the slider right/left to increase/decrease the Brilliance level.

#### ■ User

The User Tone Control option allows finer control over the instrument's sound character, allowing the volume of four frequency bands to be adjusted individually. It is also possible to adjust the frequency range of the mid-low and mid-high frequency bands.

1. Tap the < > buttons to select the "User" Tone Control type.
2. Tap the [Edit] button to open the User Tone Control setting window.
3. Tap the < > buttons to select the desired frequency range.
4. Drag the slider right/left to increase/decrease the level.



## (2) Wall EQ (NV5S only)

The Wall EQ setting adjusts the character of the hybrid piano's speaker system in order to achieve optimum sound when the rear of the instrument is placed in front of a wall.

Type	Description
Off	Optimise the speaker system for placing the hybrid piano in an area away from a wall.
Wall 1	Optimise the speaker for placing the hybrid piano in front of a heavy wall such as brick/concrete.
Wall 2	Optimise the speaker for placing the hybrid piano in front of a light wall such as plasterboard.



## (3) Low Volume Balance

The Low Volume Balance setting reduces the difference in volume between pianissimo and fortissimo touches, allowing the piano to continue to be played at low volume without the sound of pianissimo notes being lost.

Type	Description
Off	Low Volume Balance adjustment is not applied.
Type1	A small amount of Low Volume Balance adjustment will be applied.
⋮	⋮
Type5	A large amount of Low Volume Balance adjustment will be applied.



## (4) Speaker Volume

The Speaker Volume setting allows the maximum volume level of the hybrid piano's speaker output to be reduced, providing finer adjustment control over the master volume. This setting can also function as a volume limiter, preventing the instrument from being played too loudly in the home or classroom etc.

Type	Description
Normal	The instrument's speakers will output sound at the normal volume level.
Low	The instrument's speakers will output sound at a reduced volume level.

### CHECK

This setting does not affect the headphones or Line Out volume.



## (5) Spatial Headphone Sound

Spatial Headphone Sound is a special feature of the hybrid piano that enhances the depth and realism of the acoustic piano sound when listening through headphones or earphones.

The Spatial Headphone Sound setting allows the player to select from one of three different acoustic presets that adjust the spatial positioning of the sound, while also helping to reduce auditory fatigue when using earphones or headphones for extended periods of time.

Type	Description
Off	Disable the Spatial Headphone Sound feature.
Forward	Front focused, somewhat narrow spatial positioning.
Normal	Naturally balanced spatial positioning that is neither forward nor wide.
Wide	Wide, very open spatial positioning.

### CHECK

This setting does not affect the speaker or Line Out sound.



## (6) Headphone Type

The Headphone Type setting optimises the sound of the hybrid piano when listening through different types of headphones or earphones.

Type	Description
Normal	Disables headphone optimisation.
Open	Optimises the sound for open type headphones.
Semi-open	Optimises the sound for semi-open type headphones.
Closed	Optimises the sound for closed type headphones.
Inner-Ear	Optimises the sound for inner-ear type headphones.
Canal	Optimises the sound for canal-type headphones.

### CHECK

This setting does not affect the speaker or Line Out sound.



## (7) Headphone Volume

The Headphone Volume setting allows the maximum volume level of the headphones output to be increased.

The default setting for Headphone Volume is "Normal" in order to protect an individual's ears from excessive volume levels. The "High" setting may be selected when using headphones with a high impedance, or in situations where it is desirable to increase the maximum volume level of the headphones output.

Type	Description
Normal	The instrument's headphone connectors will output sound at the normal volume level.
High	The instrument's headphone connectors will output sound at an increased volume level.

### CHECK

This setting does not affect the speaker or Line Out sound.



## (8) Line In Volume

---

The Line In Volume setting allows the volume level of the instrument's Line In input jacks to be adjusted digitally. This setting may be useful when using the USB Recorder function and attempting to balance an external audio source with the instrument's sound.

Drag the Line In Volume slider right/left to increase/decrease the level of the Line In Volume setting.

### CHECK

The Line In Volume can also be adjusted by using the LEVEL knob, located on the jack panel. (NV10S only)

### ■ Line In Volume setting vs Line In LEVEL knob (NV10S only)

---

The NV10S hybrid piano provides two methods of adjusting the level of the Line In audio: the Line In LEVEL knob (located beside the Line In connector on the jack panel), and the Line In Volume setting. The LEVEL knob is used to adjust the analogue volume of the sound entering the instrument, while the Line In Volume setting adjusts the digital volume of the sound once it is "inside" the instrument.

To ensure the Line In audio is of a high quality, it is recommended to set the volume of the external audio device (for example a tablet) to a high level, then adjust the instrument's Line In LEVEL knob to a comfortable level, without distortion. If it is necessary to further increase or decrease the volume of the external audio, the Line In Volume setting can then be used as desired.

## 2. 4 Hands Mode

This menu category is used to enable and adjust the 4Hands Mode function.

The 4Hands playing mode function divides the keyboard into two sections in a similar way to that of the Split keyboard mode. However, with 4Hands keyboard mode enabled, the octave/pitch of each section is automatically adjusted to create two separate 44-key instruments with the same playing range. Furthermore, the damper (right) pedal and soft (left) pedal act as separate damper pedals for the respective right and left sections, allowing two people to perform piano duets using a single instrument.

1. From the Menu, tap "4 Hands Mode".

The 4 Hands window will appear, and the keyboard will be divided into right and left sections.

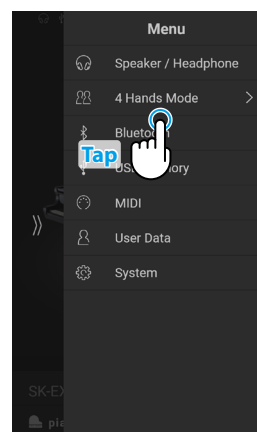

2. For each of the right and left sections, tap the desired instrument type icon, then tap the < > buttons to change the selected sound.

3. Tap the X button to close the 4Hands window and return to the Normal playing mode.

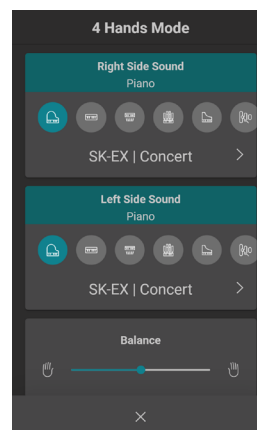

When 4 Hands playing mode is selected, the following settings will be displayed.

- **Balance**

This setting is used to adjust the volume balance between the Right and Left section sounds. Drag the Balance slider right/left to increase the volume of the Right/Left sounds.

- **Octave Shift**

This setting is used to lower/raise the pitch of the Right and Left section sounds in octave steps. Tap the [-] and [+] buttons to change the Octave Shift value for each section. The Octave Shift value can be adjusted in with the range of 0~+3.

- **Split Point**

This setting is used set the point on the keyboard that divides the Right and Left sections. Tap the [-] and [+] buttons to change the Split Point.

## 3. Bluetooth

This menu category contains settings to adjust the instrument's Bluetooth MIDI and Audio functions.



### (1) Bluetooth MIDI

The Bluetooth MIDI setting is used to enable/disable the hybrid piano's Bluetooth MIDI function. When enabled, the hybrid piano can be connected to smart phones, tablets, and other smart devices to facilitate wireless MIDI communication, allowing a wide range of music-related apps to be enjoyed using the instrument.

Value	Description
Off	The instrument's Bluetooth MIDI function will be turned off.
On	The instrument's Bluetooth MIDI function will be turned on.

#### CHECK

Availability of Bluetooth MIDI function dependent on market location.

#### ■ Connecting the hybrid piano to a smart device using Bluetooth MIDI

After enabling the Bluetooth MIDI function of the hybrid piano, enable Bluetooth communications on the smart device, then open the desired MIDI app. After a few seconds "NV10S/NV5S" should appear in the app's device list. Tap the NV10S/NV5S entry to connect the instrument to the smart device. It should now be possible for MIDI apps to communicate wirelessly with the hybrid piano.

#### CHECK

- Please check for Bluetooth MIDI compatibility with the smart device manufacturer and app developer.
- For a list of potential issues and recommended solutions when using Bluetooth communications, please refer to page 77 of this owner's manual.
- For more detailed instructions regarding Bluetooth connectivity, please refer to the supplementary Bluetooth® Connectivity Guide, available from the Kawai Global website: <https://www.kawai-global.com/support/bluetooth>

### (2) Bluetooth MIDI Device Name

The Bluetooth MIDI Device Name setting is used to change the name of the hybrid piano's Bluetooth MIDI device. This setting may be useful when using multiple NV10S/NV5S instruments in close proximity (e.g. a classroom environment), where each piano requires a unique identification name.



### (3) Bluetooth Audio

The Bluetooth Audio setting is used to enable/disable the hybrid piano's Bluetooth Audio function. When enabled, the hybrid piano can be connected to smart phones, tablets, and other smart devices to facilitate wireless audio communication, allowing music stored on a device to be played through the instrument's speaker system/headphones.

When using the USB audio recorder function, the Bluetooth Audio stream will also be mixed with the instrument's internal sound and recorded to the MP3/WAV file.

This setting is disabled by default.

Value	Description
Off	The instrument's Bluetooth Audio function will be turned off.
On	The instrument's Bluetooth Audio function will be turned on.

#### CHECK

Availability of Bluetooth Audio function dependent on market location.

#### ■ Connecting the hybrid piano to a smart device using Bluetooth Audio

After enabling the Bluetooth Audio function of the hybrid piano, enable Bluetooth communications on the smart device. After a few seconds "NV10S/NV5S Audio" should appear in the smart device's Bluetooth settings device list. Tap the NV10S/NV5S Audio entry to connect the instrument to the smart device. It should now be possible for audio produced by the smart device to be heard through the instrument's speaker system/headphones.

#### CHECK

- If loss of audio/connectivity or noise occurs, please check for Bluetooth Audio compatibility with the smart device manufacturer.
- For a list of potential issues and recommended solutions when using Bluetooth communications, please refer to page 77 of this owner's manual.
- For more detailed instructions regarding Bluetooth connectivity, please refer to the supplementary Bluetooth® Connectivity Guide, available from the Kawai Global website: <https://www.kawai-global.com/support/bluetooth>
- The Auto Power Off setting will still be observed when playing audio via Bluetooth Audio.



### (4) Bluetooth Audio Volume

The Bluetooth Audio Volume setting is used to increase or decrease the volume level of Bluetooth Audio playback. While it's generally preferable to adjust the audio volume level on the smart device itself, this setting may still be useful in certain situations.

Drag the slider right/left to increase/decrease the Bluetooth Audio Volume setting.

#### CHECK

Increasing the Bluetooth Audio Volume setting above normal levels may result in distortion or reduced audio quality.

### 4. USB Memory

This menu category contains functions related to using a USB memory device with the hybrid piano.

If a message prompting to format the USB memory device is displayed when connected to the [USB to DEVICE] port, please ensure that the data stored on the device will not be required before formatting.

Formatting the USB memory device will erase all data stored on the device.

#### CHECK

- The USB Memory category will only be displayed if a USB memory device is connected to the hybrid piano's USB to Device port.
- The USB memory device may contain data that is not displayed when connected to the hybrid piano, therefore please exercise caution when using the Format function in order to prevent accidental data loss.

### 5. MIDI

The MIDI menu contains various functions and settings related to MIDI.

#### CHECK

For information regarding MIDI functions and settings, please download the supplementary PDF manual from the Kawai Global website:

<https://www.kawai-global.com/support/manual>

### 6. User Data

#### (1) Sounds | Favorite

Reset (remove) all of the sounds specified from the Favorite category.

#### (2) Sounds | Recently Played

Reset (remove) all of the sounds specified from the Recently Played category.

#### (3) Sounds | User

Reset (remove) all of the sounds specified from the User category.

#### (4) Music | Favorite

Reset (remove) all of the songs/pieces specified in from the Favorite category.

#### (5) Music | Recently Played

Reset (remove) all of the songs/pieces specified in from the Recently Played category.

#### (6) Music | Recorder

Reset (remove) all of the songs/pieces recorded to the instrument's internal memory.

#### (7) Factory Reset

Reset all stored sounds and settings, erase songs/pieces recorded to the instrument's internal memory, and restore the hybrid piano back to its factory default configuration.



# 7. System

The System Menu contains functions and settings to adjust the LCD touchscreen appearance, and the instrument's start-up behavior.

## (1) LCD Brightness



The LCD Brightness setting is used to adjust the brightness of the hybrid piano's touchscreen display. Drag the slider right/left to increase/decrease the LCD brightness.

## (2) Display Scale



The Display Scale setting is used to adjust the size of the text and interface used by the hybrid piano's touchscreen display. Drag the slider right/left to increase/decrease the size of the text and interface.

## (3) Auto Display Off



The Auto Display Off setting determines whether or not the hybrid piano's touchscreen display will turn off automatically after a period of inactivity. This setting may be desirable if the display becomes a distraction when playing in low-light environments.

Value	Description
Never	The instrument's LCD display will remain turned on at all times.
30 Seconds	The instrument's LCD display will turn off automatically after the specified period of time.
⋮	
5 Minutes	

## (4) Auto Power Off



The Auto Power Off setting can be used to automatically turn off the hybrid piano after a specified period of inactivity. This function may be enabled by default, depending on the market location.

Value	Description
Never	The Auto Power Off function is disabled.
15 Minutes	The instrument will turn off automatically after 15 minutes of inactivity.
60 Minutes	The instrument will turn off automatically after 60 minutes of inactivity.
120 Minutes	The instrument will turn off automatically after 120 minutes of inactivity.

### CHECK

The Auto Power Off setting will still be observed when playing audio via Bluetooth Audio.

## Settings Menu

### (5) Startup Screen



The Startup Screen setting determines which screen will be shown when the hybrid piano initially starts-up.

Type	Description
PIANO	The hybrid piano will start-up with the PIANO screen.
SOUNDS	The hybrid piano will start-up with the SOUNDS screen.
MUSIC	The hybrid piano will start-up with the MUSIC screen.

### (6) Startup Settings



The Startup Settings setting determines which settings will be used when the hybrid piano starts-up.

Type	Description
Reset	The hybrid piano will always start-up with the default settings.
Current	The hybrid piano will always start-up with the current (at the time of selection) instrument settings.
Power Off	The hybrid piano will always start-up with the settings that were used when the instrument was turned-off.

### (7) Language



The Language setting determines which language will be used for the hybrid piano's LCD display user interface.

Type	Description
日本語	The LCD display user interface will be shown in Japanese.
English	The LCD display user interface will be shown in English.

### (8) Information



The Information function displays details about the hybrid piano's software version, and license information.

M E M O

# Troubleshooting

The tables below summarise issues that may be experienced with the NV10S/NV5S hybrid piano, explaining the typical cause(s), and recommended solution(s).

## ■ Power

Issue	Possible Cause and Solution	Ref.
<i>The instrument does not turn on.</i>	Check that the power cable is firmly attached to the instrument, and connected to an AC outlet.	P. 13
<i>The instrument turns itself off after a period of inactivity.</i>	Check that the "Auto Power Off" function is not enabled.	P. 73

## ■ Sound

Issue	Possible Cause and Solution	Ref.
<i>The instrument is turned on, however no sound is produced when the keys are pressed.</i>	Check that the MASTER VOLUME knob is not set to the lowest position.	P. 14
	Check that a pair of headphones (or headphone adaptor plug) are not connected to the PHONES jacks.	P. 14
	Check that the "Local Control" setting in the MIDI menu is set to On.	–
<i>The sound distorts when playing at very loud volume levels.</i>	Check that the MASTER VOLUME knob is set to an appropriate level, reducing the volume if excessive distortion is heard.	P. 14
<i>Strange sounds or noises are heard when playing with piano sounds.</i>	The NV10S/NV5S hybrid piano attempts to reproduce the rich variety of tones created by an acoustic grand piano as accurately as possible. This includes various resonances, noises, and other subtle characteristics that contribute to the overall piano playing experience.  While these additional tones are intended to enhance the realism of the instrument, it is possible to reduce their prominence, or disable the effects altogether using the settings in the Virtual Technician menu.	
	The noise occurs when the damper pedal is depressed and released. ➡ Damper Noise	P. 57
	The noise occurs after a key is released. ➡ Fall-back Noise, Key-off Effect	P. 59
	The sound has a metallic characteristic. ➡ Key-off Effect, Undamped Resonance, String Resonance	P. 57 P. 58 P. 59
	The sound is muffled or too bright. ➡ Topboard, Voicing	P. 56 P. 60
	A particular key's pitch is heard as incorrect. ➡ Temperament	P. 62
<i>The top 18 notes of the keyboard sustain for longer than neighbouring notes, even when the damper pedal is not pressed.</i>	This is the correct behaviour, and intended to reproduce the undamped notes (typically the top two octaves) of an acoustic grand piano.	–
<i>The volume of the device connected to the Line In jacks is too low/too high (distorted).</i>	Check the position of the Line In LEVEL knob (located on the jack panel), and adjust as necessary. [NV10S only]	P. 83

## ■ Pedals

Issue	Possible Cause and Solution	Ref.
<i>The pedals are unreliable or do not function at all.</i>	Check that the pedal cable is firmly connected to the instrument.	P. 89
<i>When depressing a pedal, the pedal board flexes and is not firm.</i>	Check that the pedal support bolt is fully extended.	P. 15 P. 90

## ■ Headphones

Issue	Possible Cause and Solution	Ref.
<i>The headphone volume is too low.</i>	If the "Nominal Impedance" specification of the headphones is less than 100 $\Omega$ (ohms), set the "Headphone Volume" setting in the Speaker/Headphone menu to High.	P. 67
<i>The headphone output sounds strange.</i>	Check that the "Spatial Headphone Sound" and "Headphone Type" settings are set to "Normal".	P. 67

## ■ USB (memory device)

Issue	Possible Cause and Solution	Ref.
<i>A USB memory device is not detected, cannot be saved to, or does not appear to function when connected to the "USB to Device" port.</i>	Check that the USB memory device is formatted to use the FAT/FAT32 filesystem, and not set to "Write Protect" mode.	P. 83
	Disconnect the USB memory device, turn the instrument off then on, then reconnect the USB device. If the USB device still does not function, it may be damaged or incompatible. Please try using a different USB device.	-
<i>The instrument pauses briefly when connecting a USB memory device.</i>	This is recognised behaviour when using large capacity (e.g. 8GB+) USB memory devices.	-

## ■ USB MIDI, MIDI, Bluetooth® MIDI

Issue	Possible Cause and Solution	Ref.
<i>The instrument is connected to the computer using a USB cable, however the software does not respond to key presses.</i>	Check that a USB MIDI driver is installed on the computer.	P. 84
	Check that "USB Audio Device" or "KAWAI USB MIDI" is selected in the software's input/output device settings.	P. 84
	Check that the instrument is not connected to a smart device using Bluetooth MIDI.	P. 70
<i>The instrument cannot connect to the smart device/app via Bluetooth.</i>	Check that the instrument's Bluetooth MIDI/Audio function is turned On.	P. 70
	Ensure that the mobile device's Bluetooth function is turned On.	-
	Ensure that the instrument isn't already connected to another Bluetooth device.	-
	Try deleting the instrument's Bluetooth connection using the mobile device's "Forget Device" function.	-
	Try turning the instrument Off and then On, and/or restarting the mobile device.	-

## Troubleshooting

### ■ MP3/WAV/SMF files

Issue	Possible Cause and Solution	Ref.
<i>No sound can be heard when playing an MP3 or WAV audio file stored on a USB memory device.</i>	Check that the audio player volume is not set to 0.	P. 39
	Check that the format of the audio file is supported and listed in the "USB Memory Player supported formats" table.	P. 52
<i>An MP3/WAV audio file stored on a USB memory device sounds strange, or does not play back correctly.</i>	Check that the format of the audio file is supported and listed in the "USB Memory Player supported formats" table.	P. 52
	The file transfer speed of the USB memory device may be too slow to play the audio file. Please try using a different USB memory device, ensuring that it conforms to USB2.0 Hi-Speed standards.	P. 83
<i>When recording MP3/WAV audio files, the volume is too low/too high (distorted).</i>	Check the gain setting before recording the audio, and if necessary adjust to increase/decrease the recording level.	P. 52
<i>An SMF MIDI file stored on a USB memory device sounds strange when played back.</i>	The NV10S/NV5S hybrid piano does not contain the full General MIDI sound bank selection. Consequently, some SMF song files may not be reproduced entirely accurately when played through the instrument.	–

# Sound List

## Piano

SK-EX Rendering  
 SK-EX | Concert  
 SK-EX | Jazz Clean  
 SK-EX | Warm  
 EX | Concert  
 EX | Warm  
 EX | Standard  
 EX | Pop Grand  
 EX | Pop Piano  
 EX | New Age  
 EX | Modern  
 SK-5 | Classical  
 SK-5 | Jazz Old School  
 SK-5 | Pop  
 UprightPiano | Classical  
 UprightPiano | Boogie  
 UprightPiano | Honky Tonk

## Electric Piano

Classic Electric Piano  
 60's Electric Piano  
 Modern Electric Piano  
 Electric Grand  
 Classic Electric Piano 2  
 Classic Electric Piano 3  
 Classic Electric Piano 4  
 Crystal Electric Piano  
 Modern Electric Piano 2  
 Modern Electric Piano 3

## Organ

Jazz Organ  
 Blues Organ  
 Ballad Organ  
 Gospel Organ  
 Drawbar Organ  
 Drawbar Organ 2  
 Drawbar Organ 3  
 Drawbar Organ 4

## Church Organ

Church Organ  
 Diapason  
 Full Ensemble  
 Diapason Octave  
 Chiffy Tibia  
 Principal Octave  
 Principal Choir  
 Baroque  
 Soft Diapason  
 Soft Strings  
 Mellow Flutes  
 Medium Ensemble  
 Loud Ensemble  
 Bright Ensemble  
 Full Organ  
 Reed Ensemble

## Harpsichord

Harpsichord  
 Harpsichord Octave  
 Harpsichord 2

## Mallets

Vibraphone  
 Clavi  
 Marimba  
 Celesta  
 Bell Split  
 Strings  
 Slow Strings  
 String Pad  
 Warm Strings  
 String Ensemble  
 Soft Orchestra  
 Chamber Strings  
 Harp  
 Pizzicato Strings

## Vocal

Choir  
 Pop Ooh  
 Pop Aah  
 Choir 2  
 Jazz Ensemble  
 Pop Ensemble  
 Slow Choir  
 Breathy Choir

## Pad

New Age Pad  
 Square Pad  
 Itopia  
 Brightness  
 New Age Pad 2  
 Brass Pad  
 Bowed Pad  
 Bright Warm Pad

## Bass

Wood Bass  
 Electric Bass  
 Electric Bass 2  
 Wood Bass & Ride  
 Electric Bass & Ride

## Guitar

Ballad Guitar  
 Pick Nylon Guitar  
 Finger Nylon Guitar

## CHECK

Long words may be indicated as an abbreviation on the display.

# Drum Rhythm List

No.	Rhythm Name
<b>8 Beat</b>	
1	8 Beat 1
2	8 Beat 2
3	8 Beat 3
4	Pop 1
5	Pop 2
6	Pop 3
7	Pop 4
8	Pop 5
9	Pop 6
10	Ride Beat 1
11	Ride Beat 2
12	Dance Pop 1
13	Country Pop
14	Smooth Beat
15	Rim Beat
<b>8 Beat Rock</b>	
16	Modern Rock 1
17	Modern Rock 2
18	Modern Rock 3
19	Modern Rock 4
20	Pop Rock
21	Ride Rock
22	Jazz Rock
23	Surf Rock
<b>16 Beat</b>	
24	16 Beat
25	Indie Pop 1
26	Acid Jazz 1
27	Ride Beat 3
28	Dance Pop 2
29	Dance Pop 3
30	Dance Pop 4
31	Dance Pop 5
32	Dance Pop 6
33	Dance Pop 7
34	Dance Pop 8
35	Indie Pop 2
36	Cajun Rock
<b>8 Beat Ballad</b>	
37	Pop Ballad 1
38	Pop Ballad 2
39	Pop Ballad 3
40	Rock Ballad 1
41	Rock Ballad 2
42	Slow Jam
43	6/8 R&B Ballad
44	Triplet Ballad 1
45	Triplet Ballad 2
<b>16 Beat Ballad</b>	
46	16 Ballad 1
47	Dance Ballad 1
48	Dance Ballad 2
49	Dance Ballad 3
50	Electro Pop
51	16 Ballad 2
52	Mod Pop Ballad

No.	Rhythm Name
<b>16 Beat Dance</b>	
53	Dance 1
54	Dance 2
55	Dance 3
56	Disco
57	Techno 1
58	Techno 2
<b>16 Beat Swing</b>	
59	16 Shuffle 1
60	16 Shuffle 2
61	16 Shuffle 3
62	Acid Jazz 2
63	Acid Jazz 3
64	New Jack Swing
65	Modern Dance
66	Indie Pop 3
<b>8 Beat Swing</b>	
67	Swing Beat
68	Motown
69	Country 2 Beat
70	Boogie
<b>Triplet</b>	
71	8 Shuffle 1
72	8 Shuffle 2
73	8 Shuffle 3
74	Dance Shuffle
75	Triplet 1
76	Triplet 2
77	Triplet Rock
78	Reggae
<b>Jazz</b>	
79	H.H. Swing
80	Ride Swing
81	Fast 4 Beat
82	Afro Cuban
83	Jazz Bossa
84	Jazz Waltz
85	5/4 Swing
<b>Latin / Traditional</b>	
86	H.H. Bossa Nova
87	Ride Bossa Nova
88	Beguine
89	Rhumba
90	Cha Cha
91	Mambo
92	Samba
93	Sala
94	Merenge
95	Tango
96	Habanera
97	Waltz
98	Ragtime
99	March
100	6/8 March



# Sound Demo Song List

Sound Name	Song Title	Composer
<b>Piano</b>		
SK-EX Rendering	Polonaise No.6 "Héroïque"	Chopin
SK-EX   Concert	La Campanella	Liszt
SK-EX   Jazz Clean	Original	Kawai
SK-EX   Warm	Sonata No.30 Op.109	Beethoven
EX   Warm	La Fille aux Cheveux de lin	Debussy
EX   Standard	Petit chien	Chopin
EX   Pop Grand	Original	Kawai
EX   Pop Piano	Original	Kawai
EX   New Age	Original	Kawai
EX   Modern	Original	Kawai
SK-5   Classical	Lieder Ohne Worte No.18 "Duetto"	Mendelssohn
UprightPiano   Classical	Nocturne No. 20 Op. posth.	Chopin
<b>Electric Piano</b>		
Classic Electric Piano	Original	Kawai
Modern Electric Piano	Original	Kawai
Modern Electric Piano 2	Original	Kawai
<b>Organ</b>		
Jazz Organ	Original	Kawai
Blues Organ	Original	Kawai
Drawbar Organ	Original	Kawai
<b>Church Organ</b>		
Church Organ	Chorale Prelude "Wachet auf, ruft uns die Stimme."	Bach
Diapason	Wohl mir, daß ich Jesum have	Bach
Full Ensemble	Original	Kawai
<b>Harpsichord</b>		
Harpsichord	French Suite No.6	Bach
Harpsichord Octave	Prelude in Ab	Bach
<b>Mallets</b>		
Vibraphone	Original	Kawai
Clavi	Original	Kawai
<b>Strings</b>		
Slow Strings	Original	Kawai
String Pad	Original	Kawai
String Ensemble	Le quattro stagioni La primavera	Vivaldi
<b>Vocal</b>		
Choir	Londonderry Air	Irish folk song
Choir 2	Original	Kawai
Jazz Ensemble	Original	Kawai
<b>Pad</b>		
New Age Pad	Original	Kawai
Square Pad	Original	Kawai
<b>Bass</b>		
Wood Bass	Original	Kawai
Electric Bass	Original	Kawai
Electric Bass 2	Original	Kawai
Wood Bass & Ride	Original	Kawai
<b>Guitar</b>		
Ballad Guitar	Original	Kawai
Pick Nylon Gt.	Original	Kawai

# Connecting to Other Devices

The NV10S/NV5S hybrid piano features a variety of jacks that allow the instrument to be connected to MIDI devices, computers, speakers, and mixers. It is also possible to connect external audio sources, such as an MP3 player, tablet, or a secondary keyboard, to the instrument's amplifier and speaker system. The illustration below provides a visual overview of the connectors and their typical applications.

## [ NV10S ]

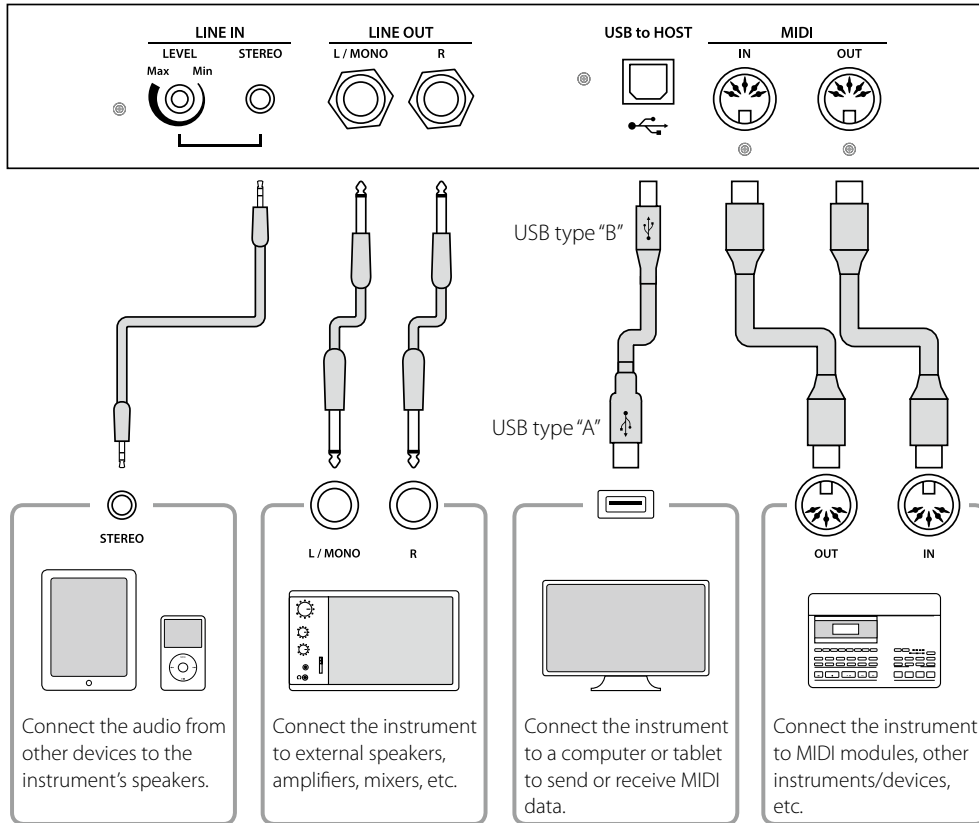

## [ NV5S ]

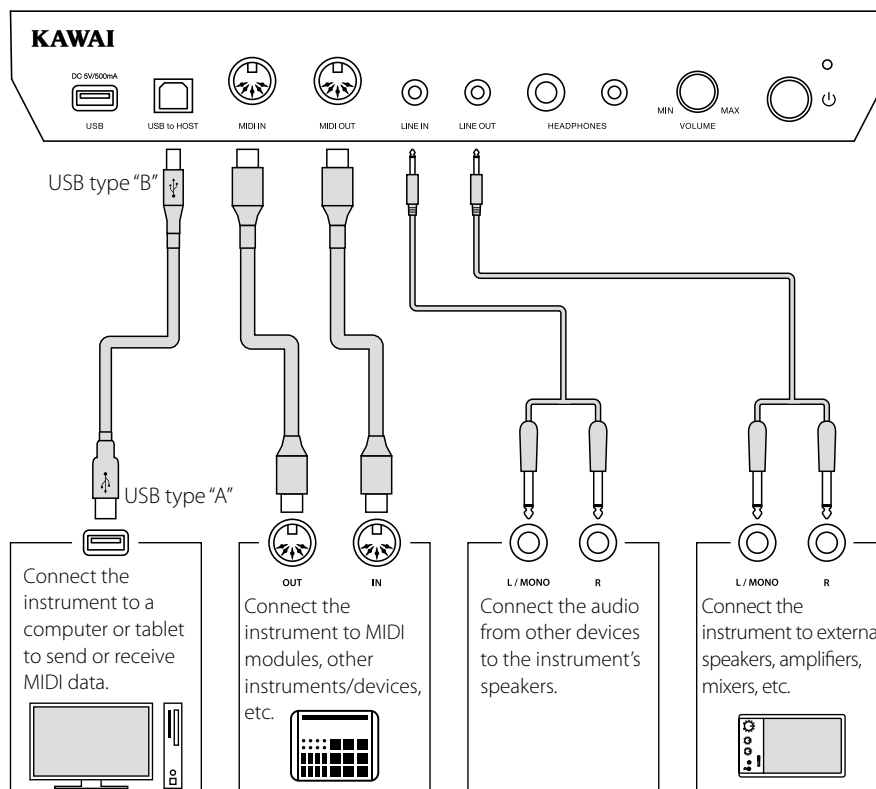

# Jack Panel and Headphone Panel (NV10S) / Jack/Control Box (NV5S)

## ■ LINE IN STEREO jack (1/8" phone jack)

This jack is used to connect the 1/8" stereo outputs from smart phones, tablets, computers, or other electronic audio equipment to the NV10S/NV5S hybrid piano's amplifier and speakers. The input level can be adjusted using the LEVEL knob (NV10S only), or by adjusting the volume of the connected device.

When using the USB audio recorder function, this LINE in audio will also be mixed with the instrument's internal sound and recorded to the MP3/WAV file.

\* The "Line In Volume" setting can also be used to adjust the level of the LINE IN signal.

 "Line In Volume" P. 68

## ■ USB to Host port ("B" type)

This USB port is used to connect the NV10S/NV5S hybrid piano to a computer using an inexpensive USB cable. When connected, the instrument can be used as a standard MIDI device, allowing it to send and receive MIDI data. Connect a "B" type USB connector to the instrument, and an "A" type USB connector to the computer.

 "USB MIDI information" P. 84

With additional conversion adaptors, this port may also be used to connect the NV10S/NV5S hybrid piano to tablets and other mobile devices.

## ■ PHONES jacks (1/4" & 1/8" phone jacks)

These jacks are used to connect stereo headphones to the NV10S/NV5S hybrid piano. Two pairs of headphones can be connected and used simultaneously. When a pair of headphones is connected, sound will not be produced by the speakers.

## ■ USB device information

- The "USB to Device" functionality of the NV10S/NV5S hybrid piano conforms to USB2.0 Hi-Speed standards. Older USB devices can still be used, however data transfer speed will be limited to the maximum transfer speed of the device.
- Only connect USB memory devices to the USB to Device port.
- Connect the USB memory device directly, without using a USB extension cable.

## ■ LINE OUT jacks

(NV10S : 1/4" phone jacks NV5S : 1/8" phone jack)

These jacks are used to connect the stereo output of the NV10S/NV5S hybrid piano's sound to external speakers, amplifiers, mixers, recording devices, and similar equipment.

To output a mono signal, connect a single cable to the L/MONO jack. (NV10S only)

The LINE OUT level can be adjusted using the MASTER VOLUME knob.

## ■ MIDI IN/OUT jacks

These jacks are used to connect the NV10S/NV5S hybrid piano to external MIDI devices, or to a computer (using a USB-MIDI interface) as an alternative to the "USB to Host" port.

 "MIDI" P. 72

## ■ USB to Device port ("A" type)

This USB port is used to connect a USB memory device to the NV10S/NV5S hybrid piano. This allows MP3/WAV audio files, and SMF song files to be played directly. It is also possible to record performances to MP3/WAV audio files, and save recorder songs stored in internal memory for posterity.

\* Only connect USB memory devices to the USB to Device port.

\* Connect the USB memory device directly, without using a USB extension cable.

- It may be necessary to format the USB memory device before it can be used with the NV10S/NV5S hybrid piano. Formatting the device will erase all data.
- Avoid removing the USB memory device while data is being loaded or saved, files are being renamed or deleted, or the device is being formatted.
- Other USB devices, such as computer mice, keyboards, or battery chargers etc. cannot be used with this instrument.



Make sure to turn off the power of the instrument before connecting with other equipment.

# USB MIDI (USB to Host Connector)

The NV10S/NV5S hybrid piano features a “USB to Host” type connector, allowing the instrument to be connected to a computer using an inexpensive USB cable and utilised as a MIDI device. Depending on the type of computer and operating system installed, additional driver software may be required for USB MIDI communication to function correctly.

For more information regarding the USB MIDI driver, please visit the following website:

<https://www.kawai-global.com/support/downloads/>

## ■ USB MIDI information

---

- Ensure that the instrument is turned OFF before attempting to connect the USB MIDI cable.
- When connecting the instrument to a computer using the USB MIDI port, there may be a short delay before communications begin.
- If the instrument is connected to a computer via a USB hub and USB MIDI communication becomes unreliable/unstable, please connect the USB MIDI cable directly to the one of the computer's USB ports.
- Disconnecting the USB MIDI cable suddenly, or turning the instrument on/off while using USB MIDI may cause computer instability in the following situations:
  - while installing the USB MIDI driver
  - while starting up the computer
  - while MIDI applications are performing tasks
  - while the computer is in energy saver mode
- If there are any further problems experienced with USB MIDI communication while the instrument is connected, please double-check all connections and relevant MIDI settings in the computer's operating system.

# Information about Bluetooth®

Please refer to the following information about Bluetooth.

## ■ About Bluetooth

- The Bluetooth® word mark and logos are registered trademarks owned by the Bluetooth SIG, Inc. and any use of such marks by Kawai Musical Instruments Mfg. Co., Ltd. is under license.
- Frequency Band of Radio: 2400~2483.5 MHz Maximum Transmit Power: 2.5 mW (Bluetooth Low Energy), 4.5mW (A2DP)
- Availability of Bluetooth function dependent on market location.

## ■ For USA, Canada

It is strictly forbidden to use antenna except designated.  
This equipment must not be co-located or operated in conjunction with any other antenna or transmitter.

## ■ For Canada

- This device complies with Industry Canada's licence-exempt RSSs. Operation is subject to the following two conditions:  
(1) This device may not cause interference; and  
(2) This device must accept any interference, including interference that may cause undesired operation of the device.
- Le présent appareil est conforme aux CNR d'Industrie Canada applicables aux appareils radio exempts de licence. L'exploitation est autorisée aux deux conditions suivantes :  
(1) l'appareil ne doit pas produire de brouillage;  
(2) l'utilisateur de l'appareil doit accepter tout brouillage radioélectrique subi, même si le brouillage est susceptible d'en compromettre le fonctionnement.

## ■ For South Africa



## ■ For Argentina

Marca : KAWAI, Bluegiga **CNC** C-17079  
Modelo : MBH7BLZ07, WT32i C-21199

## ■ For Korea

- 해당 무선설비는 전파혼신 가능성이 있으므로 인명안전과 관련된 서비스는 할 수 없습니다
- B 급 기기 (가정용 방송통신기자재) 이 기기는 가정용 (B 급) 전자파적합기로서 주로 가정에서 사용하는 것을 목적으로 하며, 모든 지역에서 사용할 수 있습니다.
- 모델명 MBH7BLZ07 WT32i-A
- 인증을받은 상표 이름제조사 Kawai Musical Instruments Manufacturing Co., Ltd. Bluegiga Technologies Oy
- 원산지 일본 핀란드
- 기자재 명칭 정소출력 무선기기 (무선데이터통신시스템용 무선기기)
- 제조년 월 제품에 붙어있는 라벨을 확인하시기 바랍니다.

## ■ For Mexico

PIANO DIGITAL  
MARCA : KAWAI  
MODELO : MBH7BLZ07, RCPKAMB16-1764  
: WT32i, RCPKAWT17-1556



La operación de este equipo está sujeta a las siguientes dos condiciones:

- (1) es posible que este equipo o dispositivo no cause interferencia perjudicial
- (2) este equipo o dispositivo debe aceptar cualquier interferencia,

## ■ For Brazil

Este equipamento opera em caráter secundário, isto é, não tem direito a proteção contra interferência prejudicial, mesmo de estações do mesmo tipo e não pode causar interferência a sistemas operando em caráter primário. Para consultas, visite: [www.anatel.gov.br](http://www.anatel.gov.br)



04349-16-10021  
02414-18-01395

## ■ For Taiwan

第十二條 經型式認證合格之低功率射頻電機，非經許可，公司、商號或使用者均不得擅自變更頻率、加大功率或變更原設計之特性及功能。  
第十四條 低功率射頻電機之使用不得影響飛航安全及干擾合法通信；經發現有干擾現象時，應立即停用，並改善至無干擾時方得繼續使用。前項合法通信，指依電信法規定作業之無線電通信。低功率射頻電機須忍受合法通信或工業、科學及醫療用電波輻射性電機設備之干擾。

# Assembly Instructions (NV10S only)



Please read these assembly instructions thoroughly before attempting to assemble the NV10S hybrid piano.  
Please ensure that three or more people work on assembling the NV10S hybrid piano, especially when lifting the main body of the instrument onto the stand.

## ■ Included parts

Before attempting to assemble the NV10S hybrid piano, ensure that all parts below are included.  
A Phillips-head screwdriver (not included) will also be required in order to assemble the instrument.  
Please do not remove the main unit from the box before step 3.

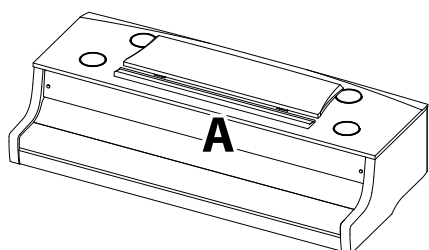

**Main body**

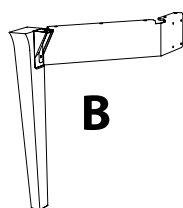

**Leg 1 (left)**

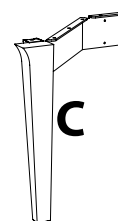

**Leg 2 (right)**

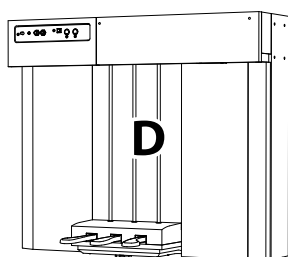

**Pedal base**

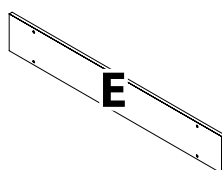

**Stand back board**

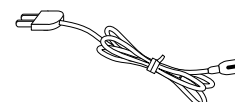

**Power cable**

### Screw set

**a** Screw (6 x 35 mm) x 12

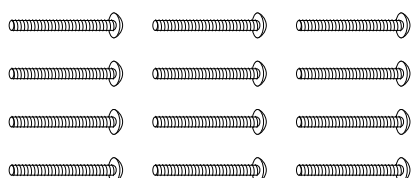

**b** Screw (4 x 30 mm) x 8

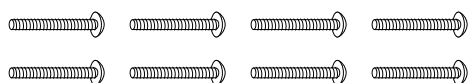

**c** Screw (4 x 20 mm) x 5

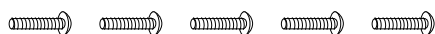

### Headphone hook set

Headphone hook



Mounting screws (4 x 14 mm) x 2



## 1. Attaching the legs to the pedal base

- 1 Place the pedal base (D) on a flat floor. Check that there are no musical scores or parts on the floor, and ensure that the pedal support bolt is attached.
- 2 Loosely attach the left leg (B) to the pedal base (D) using 4 screws ⑥.
- 3 Press the metal fitting plate of the left leg firmly against the pedal base, and ensure that the base makes firm contact with the floor, then tighten the four screws.
- 4 Attach the right leg (C) to the pedal base using the 4 remaining screws ⑥, in the same way as step 1-2.
- 5 Ensure that the assembled pedal base and legs are absolutely stable and do not rattle when pushed. If the stand is not completely steady, loosen the screws attached in the previous steps, gently reposition the parts, and then retighten the screws.

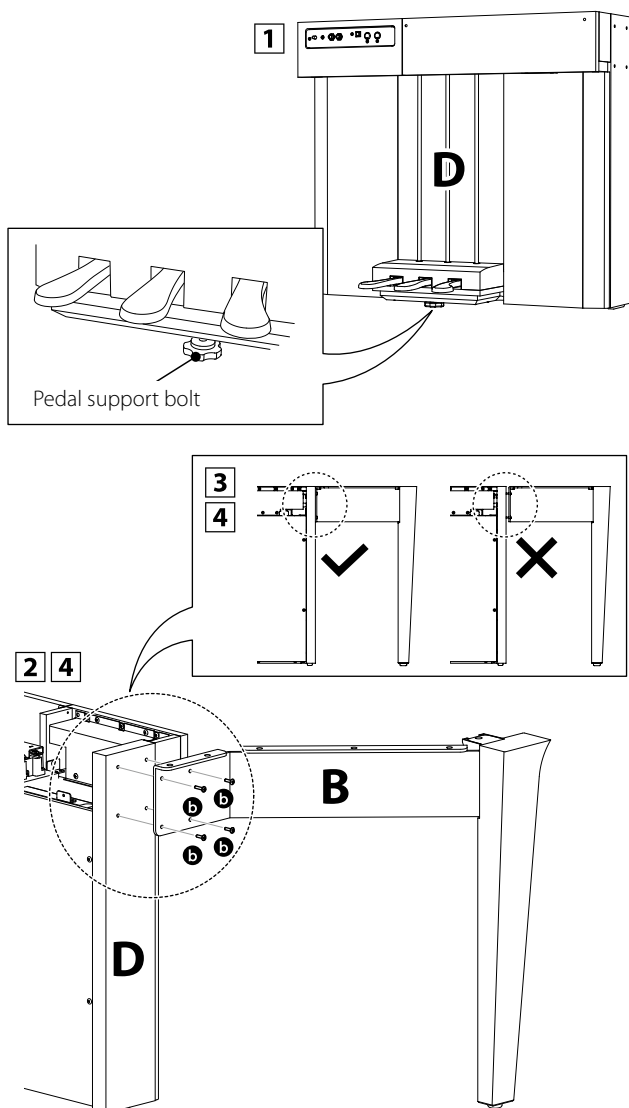

## 2. Removing the main unit from the box

- 1 Check that the main unit box is facing upward, then open the upper side of the box.

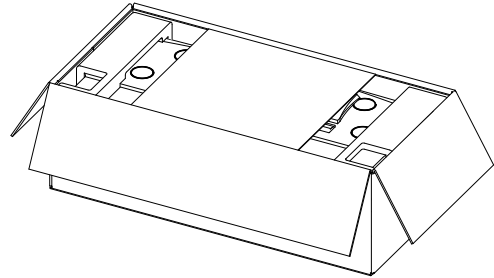

- 2 Cut the four sides of the box, and open them out fully.

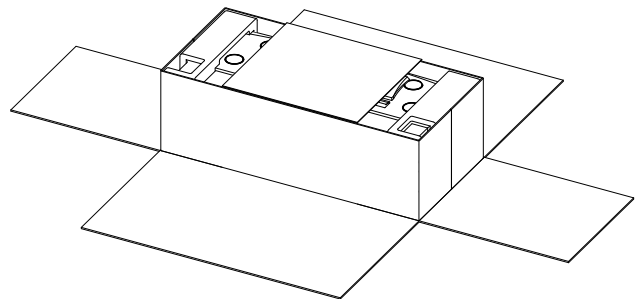

**Be careful not to injure hands or fingers when cutting the box.**

- 3 Remove the corrugated boards (side, upper side), polystyrene foam (upper side), and any remaining packaging material, to allow the main body (A) to be lifted.

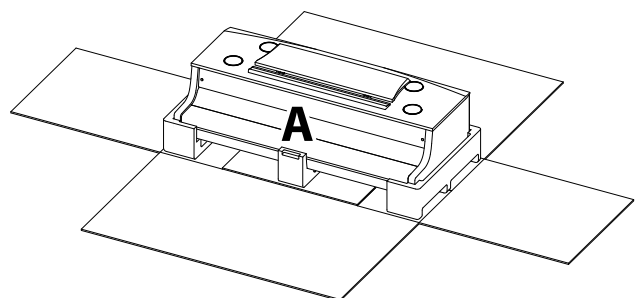

# Assembly Instructions (NV10S only)

## 3. Mounting the main body onto the stand



Ensure that three or more people undertake the following step of the assembly process.

- 1 Remove the main body from the box, lifting the unit sufficiently onto the back of the stand. Adjust the positioning to ensure that the guides on the main body fit inside the side plates of the pedal base.
- 2 Gently slide the main body forward so that when viewed from directly above, the front of the main body is aligned with the centre of the plastic parts of the stand's legs. At this point, the main body will be tilted back. Proceed to the next step promptly.
- 3 Lift the main body and gently position the unit so that its screw holes (on the underside) correctly align with the metal fittings of the stand's legs.



When lifting and positioning the main body, do not hold the gray shaded areas.

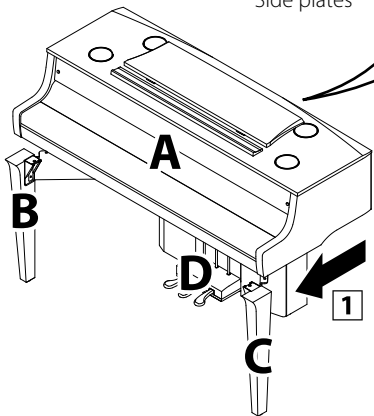
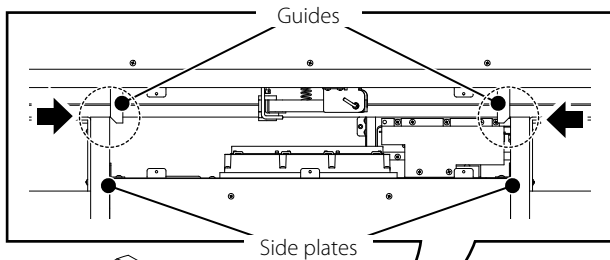
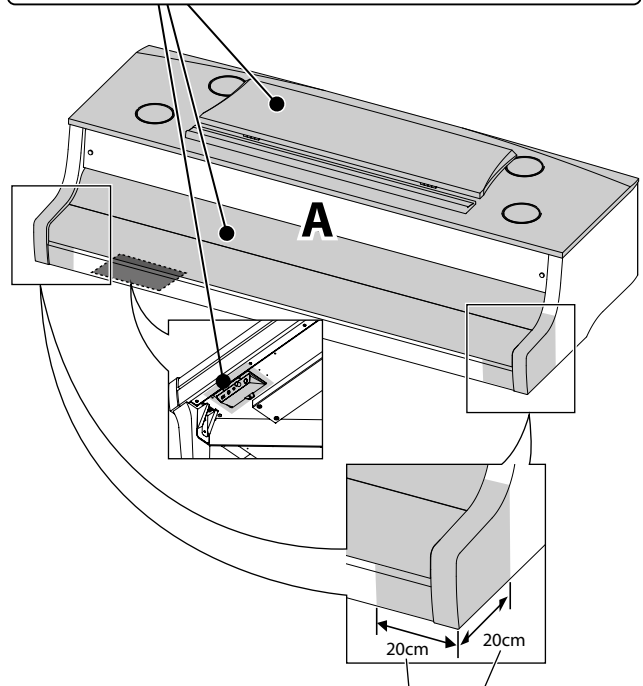

Do not hold the main body from the front of the unit, in order to prevent catching/trapping hands or fingers on the stand's legs.

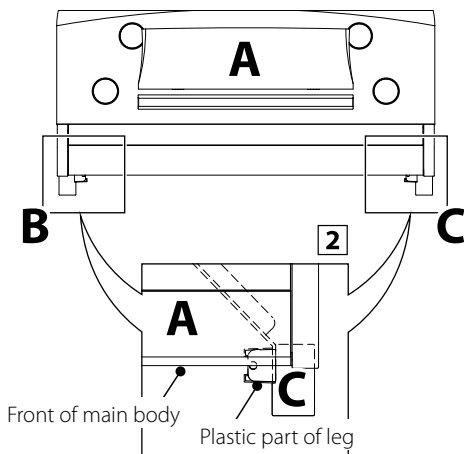
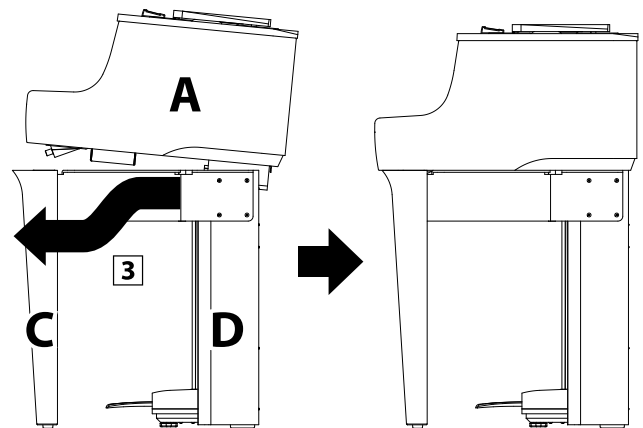

When lifting the main body onto the stand, be careful not to catch/trap hands or fingers.



#### 4. Fastening the main body to the stand

- 1 Loosely attach the main body to the stand using 2 screws **a** at the front of the instrument (through the legs), and 10 screws **b** towards the back of the instrument.
- 2 Adjust the positioning of the main body to ensure that when viewed from the front, the body and legs are correctly aligned.
- 3 When the main body and legs are correctly aligned, tighten all 12 screws firmly.
- 4 Ensure that the assembled instrument is absolutely stable and does not rattle when pushed. If the stand is not completely steady, loosen the screws attached in steps 1-2~1-4, gently reposition the parts, and then retighten the screws.

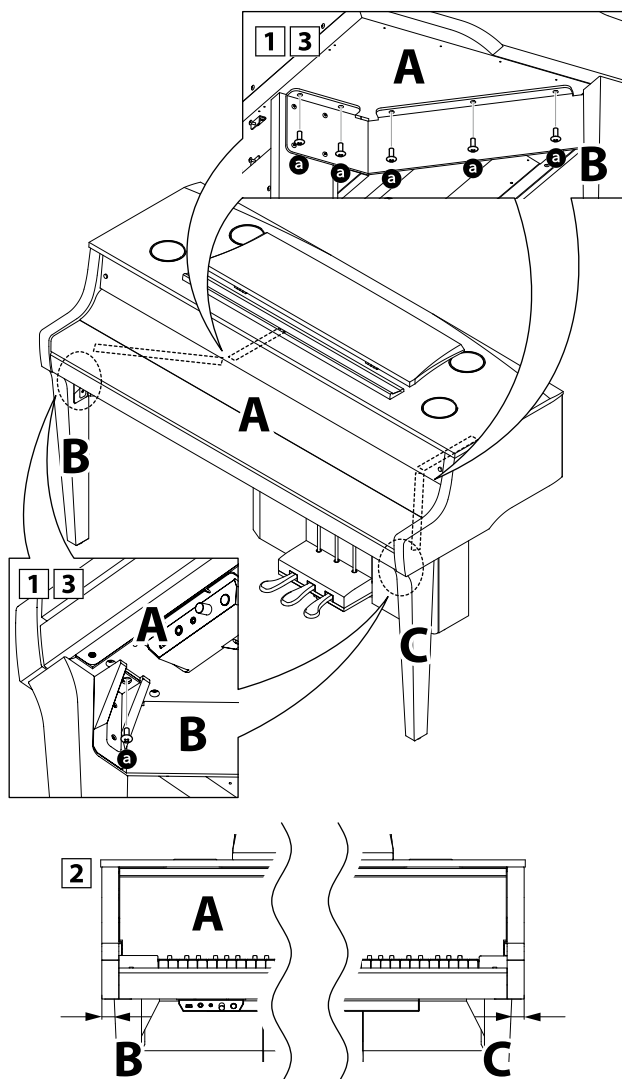

 **Tighten all screws securely to ensure that the main body is firmly attached to the stand.**

#### 5. Connecting the cords

- 1 Carefully connect the two cords to their respective plugs.
- 2 Ensure that the cords are connected securely, and that there are no gaps between the plugs.

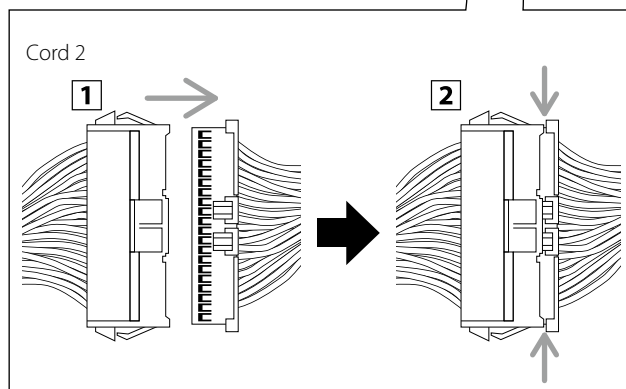
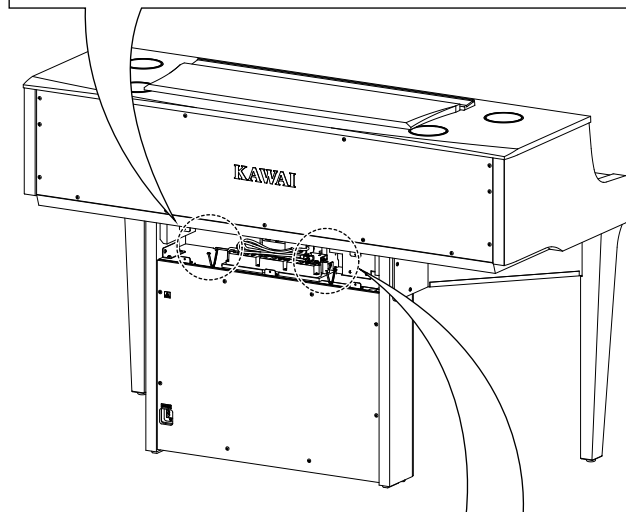
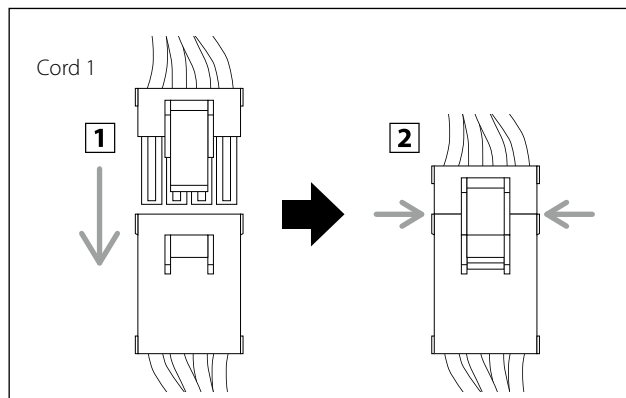

 **Ensure that the two cords are connected securely to ensure that the instrument's keyboard and pedals work correctly.**

## Assembly Instructions (NV10S only)

### 6. Attaching the stand back board

Attach the stand back board (E) to the pedal base using 5 screws .



**When attaching the stand back board, be careful not to get the cables 1 and 2 caught in the metal fittings E and D.**

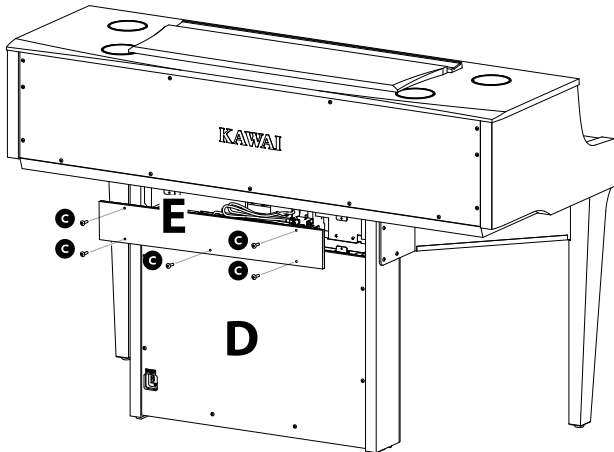

### 7. Connect the power cable to the instrument

Connect the included power cable to the AC IN terminal located on the back side of the pedal base, in the bottom left corner.

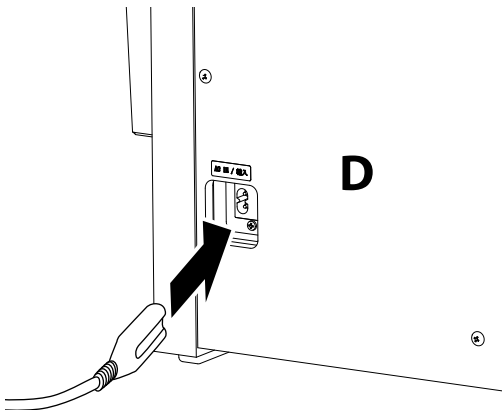

### 8. Attaching the headphone hook (optional)

A headphone hook is included with the NV10S hybrid piano and can be used to hang headphones when not in use.

If desired, attach the headphone hook to the underside of the main body using the two tapping screws provided.

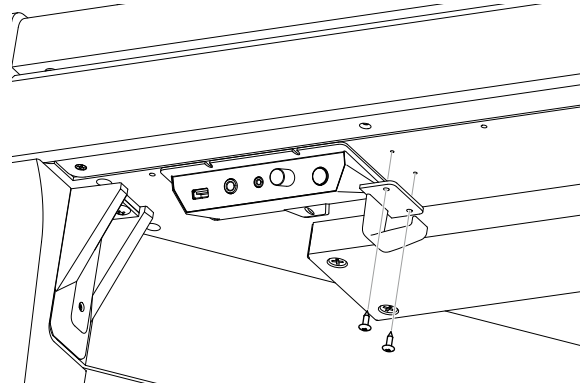

### 9. Adjusting the pedal support bolt

Turn the pedal support bolt anti-clockwise, extending the bolt until it makes contact with the floor and supports the pedals firmly.

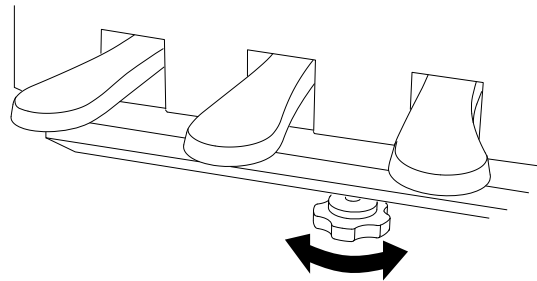

**When moving the instrument, always retract (raise) the pedal support bolt, then readjust when the instrument is in its new position. Also, ensure that the instrument is moved by lifting and not dragged or pushed.**

# EU Declaration of Conformity

<b>BG</b>	<b>ОПРОСТЕНА ЕС ДЕКЛАРАЦИЯ ЗА СЪОТВЕТСТВИЕ</b>
Bulgarian	С настоящото Kawai Европа GmbH декларира, че този тип радиосъоръжение [ NV10S/NV5S ] е в съответствие с Директива 2014/53/ЕС. Цялостният текст на ЕС декларацията за съответствие може да се намери на следния интернет адрес:
<b>ES</b>	<b>DECLARACIÓN UE DE CONFORMIDAD SIMPLIFICADA</b>
Spanish	Por la presente, Kawai Europa GmbH declara que el tipo de equipo radioeléctrico [ NV10S/NV5S ] es conforme con la Directiva 2014/53/UE. El texto completo de la declaración UE de conformidad está disponible en la dirección Internet siguiente:
<b>CS</b>	<b>ZJEDNODUŠENÉ EU PROHLÁŠENÍ O SHODĚ</b>
Czech	Tímto Kawai Europa GmbH prohlašuje, že typ rádiového zařízení [ NV10S/NV5S ] je v souladu se směrnicí 2014/53/EU. Úplné znění EU prohlášení o shodě je k dispozici na této internetové adrese:
<b>DA</b>	<b>FORENKLET EU-OVERENSSTEMMELSESERKLÆRING</b>
Danish	Hermed erklærer Kawai Europa GmbH, at radioudstyrstypen [ NV10S/NV5S ] er i overensstemmelse med direktiv 2014/53/EU. EU-overensstemmelseserklæringens fulde tekst kan findes på følgende internetadresse:
<b>DE</b>	<b>VEREINFACHTE EU-KONFORMITÄTSERKLÄRUNG</b>
German	Hiermit erkläre Kawai Europa GmbH, dass der Funkanlagentyp [ NV10S/NV5S ] der Richtlinie 2014/53/EU entspricht. Der vollständige Text der EU-Konformitätserklärung ist unter der folgenden Internetadresse verfügbar:
<b>ET</b>	<b>LIHTSUSTATUD ELI VASTAVUSDEKLARATSIOON</b>
Estonian	Käesolevaga deklareerib Kawai Europa GmbH, et käesolev raadioseadme tüüp [ NV10S/NV5S ] vastab direktiivi 2014/53/EL nõuetele. ELi vastavusdeklaratsiooni täielik tekst on kättesaadav järgmisel internetiaadressil:
<b>EL</b>	<b>ΑΠΛΟΥΣΤΕΥΜΕΝΗ ΔΗΛΩΣΗ ΣΥΜΜΟΡΦΩΣΗΣ ΕΕ</b>
Greek	Με την παρούσα ο/η Kawai Europa GmbH, δηλώνει ότι ο ραδιοεξοπλισμός [ NV10S/NV5S ] πληροί την οδηγία 2014/53/ΕΕ. Το πλήρες κείμενο της δήλωσης συμμόρφωσης ΕΕ διατίθεται στην ακόλουθη ιστοσελίδα στο διαδίκτυο:
<b>EN</b>	<b>SIMPLIFIED EU DECLARATION OF CONFORMITY</b>
English	Hereby, Kawai Europa GmbH declares that the radio equipment type [ NV10S/NV5S ] is in compliance with Directive 2014/53/UE. The full text of the EU declaration of conformity is available at the following internet address:
<b>FR</b>	<b>DECLARATION UE DE CONFORMITE SIMPLIFIEE</b>
French	Le soussigné, Kawai Europa GmbH, déclare que l'équipement radioélectrique du type [ NV10S/NV5S ] est conforme à la directive 2014/53/UE. Le texte complet de la déclaration UE de conformité est disponible à l'adresse internet suivante:
<b>HR</b>	<b>POJEDNOSTAVLJENA EU IZJAVA O SUKLADNOSTI</b>
Croatian	Kawai Europa GmbH ovime izjavljuje da je radijska oprema tipa [ NV10S/NV5S ] u skladu s Direktivom 2014/53/EU. Cjeloviti tekst EU izjave o sukladnosti dostupan je na sljedećoj internetskoj adresi:
<b>IT</b>	<b>DICHIARAZIONE DI CONFORMITÀ UE SEMPLIFICATA</b>
Italian	Il fabbricante, Kawai Europa GmbH, dichiara che il tipo di apparecchiatura radio [ NV10S/NV5S ] è conforme alla direttiva 2014/53/UE. Il testo completo della dichiarazione di conformità UE è disponibile al seguente indirizzo Internet:
<b>LV</b>	<b>VIENKĀRŠOTA ES ATBILSTĪBAS DEKLARĀCIJA</b>
Latvian	Ar šo Kawai Europa GmbH deklarē, ka radioiekārta [ NV10S/NV5S ] atbilst Direktīvai 2014/53/ES. Pilns ES atbilstības deklarācijas teksts ir pieejams šādā interneta vietnē:
<b>LT</b>	<b>SUPAPRASTINTA ES ATITIKTIES DEKLARACIJA</b>
Lithuanian	AS, Kawai Europa GmbH, patvirtinu, kad radijo įrenginių tipas [ NV10S/NV5S ] atitinka Direktyvą 2014/53/ES. Visas ES atitikties deklaracijos teksto prieinamas šiuo interneto adresu:
<b>HU</b>	<b>EGYSZERŰSÍTETT EU-MEGFELELŐSÉGI NYILATKOZAT</b>
Hungarian	Kawai Europa GmbH igazolja, hogy a [ NV10S/NV5S ] típusú rádióberendezés megfelel a 2014/53/EU irányelvnek. Az EU-megfelelőségi nyilatkozat teljes szövege elérhető a következő internetes címen:
<b>MT</b>	<b>DIKJARAZZJONI SSIMPLIFIKATA TA' KONFORMITÀ TAL-UE</b>
Maltese	B'dan, Kawai Europa GmbH, niddikjara li dan it-tip ta' tagħmir tar-radju [ NV10S/NV5S ] huwa konformi mad-Direttiva 2014/53/UE. It-test kollu tad-dikjarazzjoni ta' konformità tal-UE huwa disponibbli f'dan l-indirizz tal-Internet li ġej:
<b>NL</b>	<b>VEREENVOUDIGDE EU-CONFORMITEITSVERKLARING</b>
Dutch	Hierbij verklaar ik, Kawai Europa GmbH, dat het type radioapparaat [ NV10S/NV5S ] conform is met Richtlijn 2014/53/EU. De volledige tekst van de EU-conformiteitsverklaring kan worden geraadpleegd op het volgende internetadres:
<b>PL</b>	<b>UPROSZCZONA DEKLARACJA ZGODNOŚCI UE</b>
Polish	Kawai Europa GmbH niniejszym oświadcza, że typ urządzenia radiowego [ NV10S/NV5S ] jest zgodny z dyrektywą 2014/53/UE. Pełny tekst deklaracji zgodności UE jest dostępny pod następującym adresem internetowym:
<b>PT</b>	<b>DECLARAÇÃO UE DE CONFORMIDADE SIMPLIFICADA</b>
Portuguese	O(a) abaixo assinado(a) Kawai Europa GmbH declara que o presente tipo de equipamento de rádio [ NV10S/NV5S ] está em conformidade com a Diretiva 2014/53/UE. O texto integral da declaração de conformidade está disponível no seguinte endereço de Internet:
<b>RO</b>	<b>DECLARAȚIA UE DE CONFORMITATE SIMPLIFICATĂ</b>
Romanian	Prin prezenta, Kawai Europa GmbH declară că tipul de echipamente radio [ NV10S/NV5S ] este în conformitate cu Directiva 2014/53/UE. Textul integral al declarației UE de conformitate este disponibil la următoarea adresă internet:
<b>SK</b>	<b>ZJEDNODUŠENÉ EÚ VYHLÁSENIE O ZHODE</b>
Slovak	Kawai Europa GmbH týmto vyhlasuje, že rádiové zariadenie typu [ NV10S/NV5S ] je v súlade so smernicou 2014/53/EÚ. Úplné EÚ vyhlásenie o zhode je k dispozícii na tejto internetovej adrese:
<b>SL</b>	<b>POENOSTAVLJENA IZJAVA EU O SKLADNOSTI</b>
Slovenian	Kawai Europa GmbH potrjuje, da je tip radijske opreme [ NV10S/NV5S ] skladen z Direktivo 2014/53/EU. Celotno besedilo izjave EU o skladnosti je na voljo na naslednjem spletnem naslovu:
<b>FI</b>	<b>YKSINKERTAISTETTU EU-VAATIMUSTENMUKAISUUSVAKUUTUS</b>
Finnish	Kawai Europa GmbH vakuuttaa, että radiolaitetyyppi [ NV10S/NV5S ] on direktiivin 2014/53/EU mukainen. EU-vaatimustenmukaisuusvakuutuksen täysimittainen teksti on saatavilla seuraavassa internetosoitteessa:
<b>SV</b>	<b>FÖRENKLAD EU-FÖRSÄKRAN OM ÖVERENSSTÄMMELSE</b>
Swedish	Härmed försäkras Kawai Europa GmbH att denna typ av radioutrustning [ NV10S/NV5S ] överensstämmer med direktiv 2014/53/EU. Den fullständiga texten till EU-försäkran om överensstämmelse finns på följande webbadress:
<a href="https://www.kawai-global.com/">https://www.kawai-global.com/</a>	

# Specifications

		NV10S	NV5S
Keyboard		Millennium III Hybrid action with 88-key graded ABS hammers and damper mechanism	Millennium III Hybrid upright piano action with 88-key graded ABS hammers and damper mechanism
Integrated Hammer Sensing System (IHSS), contact-less optical sensors			
Sound Source	SK-EX Rendering	88-key multi-channel piano sampling, 88-key resonance modelling	
	Harmonic Imaging XL	88-key piano sampling	
Internal Sounds	SK-EX Rendering	SK-EX Concert Grand (10 rendering characters)	
	Harmonic Imaging XL	90 sounds	
Keyboard Modes		Dual, Split, 4Hands (Volume/Balance adjustable) <sup>2</sup>	
Polyphony		max. 256 notes (depending on selected sound)	
Effects	SK-EX Rendering	Ambience (10 types)	
	Harmonic Imaging XL	Reverb (6 types), Effects (24 types) (Chorus x 3, Delay x 3, Tremolo x 3, Auto pan x 2, Phaser x 2, Rotary x 6, Combination x 5)	
Virtual Technician (Depending on sound)		Touch Curve, Voicing, Resonance Depth <sup>1</sup> , Damper Resonance <sup>2</sup> , Damper Noise, String Resonance <sup>2</sup> , Undamped String Resonance <sup>2</sup> , Cabinet Resonance <sup>2</sup> , Key-off Effect <sup>2</sup> , Fall-Back Noise, Hammer Noise, Hammer Delay, Topboard, Decay Time, Release Time, Minimum Touch, Stretch Tuning, Temperament <sup>2</sup> , Temperament Key <sup>2</sup> , Key Volume, Half-Pedal Adjust, Soft Pedal Depth, Tuning, Damper Hold	
Internal Recorder		10 song recorder (approximately 90,000 note memory capacity)	
USB Recorder	Playback	MP3, WAV, SMF	
	Record	MP3 (256 kbps), WAV, Overdub audio, Line In & Bluetooth Audio Recording	
Metronome		1/4, 2/4, 3/4, 4/4, 5/4, 3/8, 6/8, 7/8, 9/8, 12/8 + 100 drum rhythms 10~400 bpm (20~800 bpm for eighth note rhythms)	
Internal Songs	Demo Songs	39 songs	
	Music	204 or 218 songs <sup>3</sup>	
	Lesson Songs	578 Songs from Alfred, Burgmüller, Czerny, Beyer, Bach, and Chopin lesson books <sup>4</sup> 140 Finger Exercises	
Transpose		Key Transpose: -12~12 semi-tones, Song Transpose: -12~12 semi-tones	
Other Settings & Functions	Speaker / Headphone	Tone Control, Wall EQ (NV5S only), Low Volume Balance, Speaker Volume, Spatial Headphone Sound, Headphone Type, Headphone Volume, Line In Volume	
	Bluetooth	Bluetooth MIDI, Bluetooth MIDI Device Name, Bluetooth Audio, Bluetooth Audio Volume	
	USB Memory	Format	
	MIDI	MIDI Channel, Local On/Off, Transmit Program Change, Multi-timbral Mode, Channel Mute	
	User Data	Reset Sounds (Favorite/Recent/User), Reset Music (Favorite/Recent/Recorder), Factory Reset	
	System	LCD Brightness, Display Scale, Auto Display Off, Auto Power Off, Startup Screen, Startup Settings, Language, Information	
Display		5" LCD touchscreen (480 x 800 pixels)	
Bluetooth		Bluetooth (Version 4.1; GATT compatible), Bluetooth Low Energy MIDI Specification compliant Bluetooth Audio (Version 3.0, Profile: A2DP, Codecs: SBC, AAC, aptX)	
Jacks	Audio	LINE IN (1/8" STEREO), LINE IN Level, LINE OUT (1/4" L/MONO, R), Headphones x 2 (1/4", 1/8"),	LINE IN (1/8" STEREO), LINE OUT (1/8" STEREO), Headphones x 2 (1/4", 1/8"),
	MIDI / USB	MIDI (IN/OUT), USB to Host, USB to Device, USB for UPDATE	
Pedals		Grand Pedal System Damper (with half-pedal support), Soft (NV10S only with half-pedal support), Sostenuto	
Speaker System	Speakers	20 cm x 1 10 cm x 4 1.4 cm x 2 (dome tweeters)	Soundboard Speaker System 8 cm x 4 (top speakers) 2 cm x 2 (dome tweeters)
	Output Power	130 W	
Power Consumption		60 W	
Cabinet	Key Cover	Acoustic piano type (with Soft Fall system)	
	Music Rest	Grand piano type (6 angle adjustability)	Upright piano type (fixed angle)
Dimensions (Not including music rest)		1480 (W) x 650 (D) x 995 (H) mm 58 1/4" (W) x 25 1/2" (D) x 39 1/4" (H)	1495 (W) x 465 (D) x 1100 (H) mm 59" (W) x 18 1/3" (D) x 43 1/3" (H)
Weight		132 kg / 291 lbs.	113 kg / 249 1/2 lbs.

<sup>1</sup> SK-EX Rendering only    <sup>3</sup> Depending on market location

<sup>2</sup> Not SK-EX Rendering    <sup>4</sup> Lesson books sold separately

Specifications are subject to change without notice.

\* Availability of Bluetooth function dependent on market location.







# **KAWAI**

---

THE FUTURE OF THE PIANO

